

SINGER INSTRUCTIONS

Stylist

ZIG-ZAG SEWING MACHINE
MODEL 513

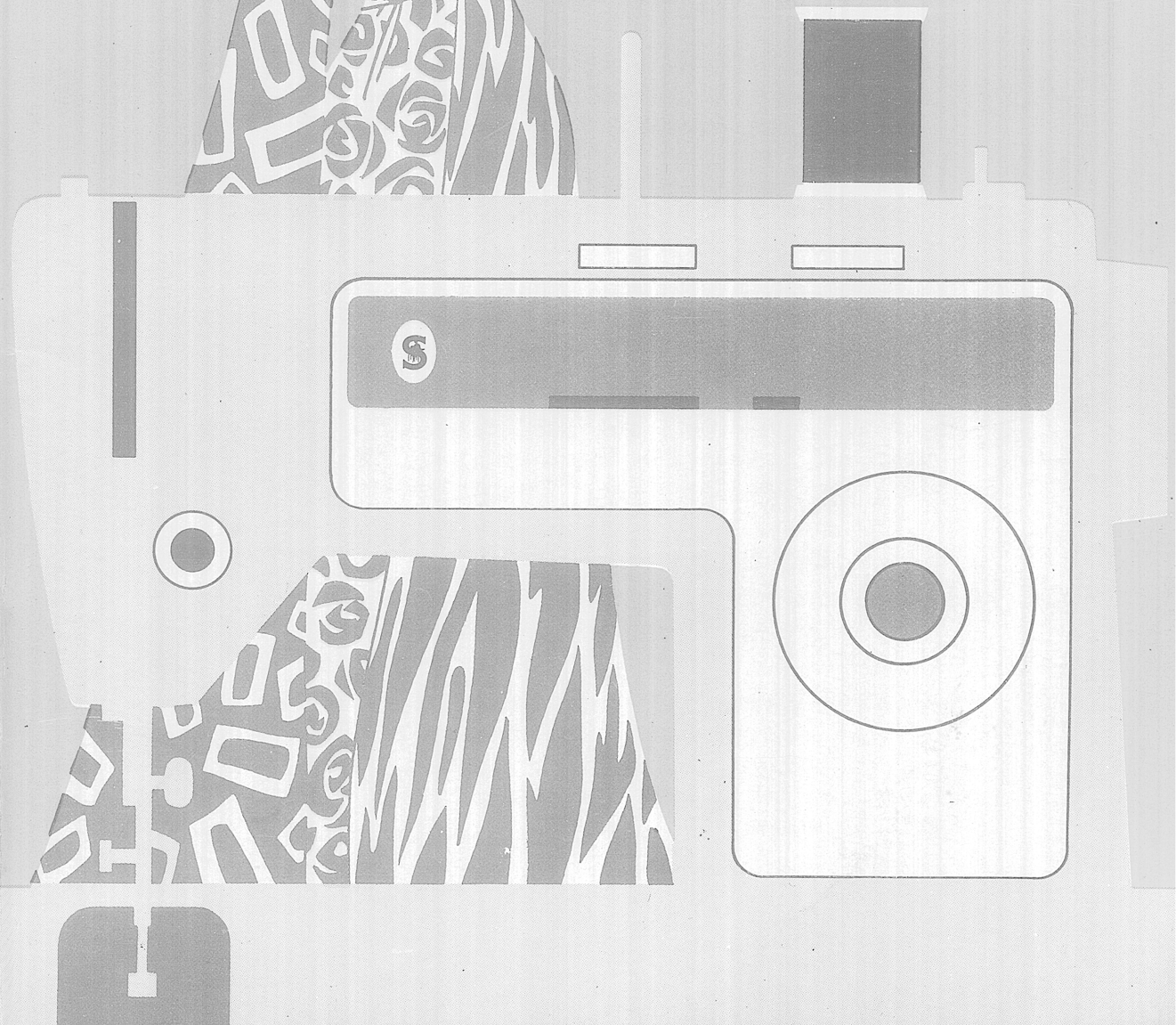

Enjoy Carefree Sewing

CONGRATULATIONS . . .

You are about to discover the wonderful pleasure of sewing with your new *Stylist** Zig-Zag Sewing Machine by SINGER. We know you are eager to get started on a sewing project . . . but we urge you to become familiar with this book before you begin. It is designed to help you get the benefit of all the capabilities of your machine. Especially, we recommend that you keep the following points in mind:

do choose the correct needle and thread for your fabric—if either is the wrong size or type, you may encounter broken or knotted thread, or faulty stitching. The Fabric, Thread, and Needle Table on page 10 will help you make a perfect choice.

don't sew with a bent or blunt needle. If the needle is damaged—or improperly inserted in the machine—it can cause skipped stitches. See page 8 for instructions.

do follow the instructions on page 14 for threading the machine.

don't forget to place the thread properly when you insert a wound bobbin. Page 13 tells you how to do this perfectly.

do become familiar with the instructions for regulating stitch length (page 17), presser-foot pressure (page 18), and thread tension (page 18). Take advantage of the capability of your sewing machine!

don't allow lint and thread ends to accumulate in the bobbin case area—they can cause jamming or excessive noise. Clean your machine regularly, as instructed on page 52.

do remember that expert, dependable SINGER* service is always available. If your sewing machine should require maintenance or repair, be sure to call your Singer Sewing Center or Authorized Singer Dealer. You will find the number listed under SINGER COMPANY in your telephone book.

Above all, *do* enjoy sewing!

CONTENTS

	Page
Getting to Know Your SINGER* Sewing Machine	2
Principal Parts—And What They Do	2
Accessories—And When to Use Them	6
Getting Ready to Sew	9
Preliminary Steps	9
Choosing Needle and Thread	10
Threading Your Sewing Machine	11
Straight Stitching	16
Adjusting Selectors	17
Sewing a Seam	19
Zig-Zag Stitching	22
Basic Zig-Zag Patterns	22
Satin Stitching	25
<i>Flexi-Stitch*</i> Patterns	26
Twin-Needle Stitching	29
Preparation	29
Threading the Needle	30
Buttons and Buttonholes	31
Buttons	31
Buttonholes	32
Sewing the Professional Way	35
Sewing Knit and Stretch Fabric	35
Hints on Sewing Special Fabrics	40
Construction Details	42
Decorative Touches	46
Keeping Up Appearances	48
Caring For Your Machine	52
Cleaning and Lubricating the Machine	52
Removing Covers, Bobbin Case, and Bulb	53
Removing Machine From Cabinet	56
Performance Checklist	57
<i>Fashion*</i> Aids	58
Your Personal Measurement Chart	59
Index	60

principal parts

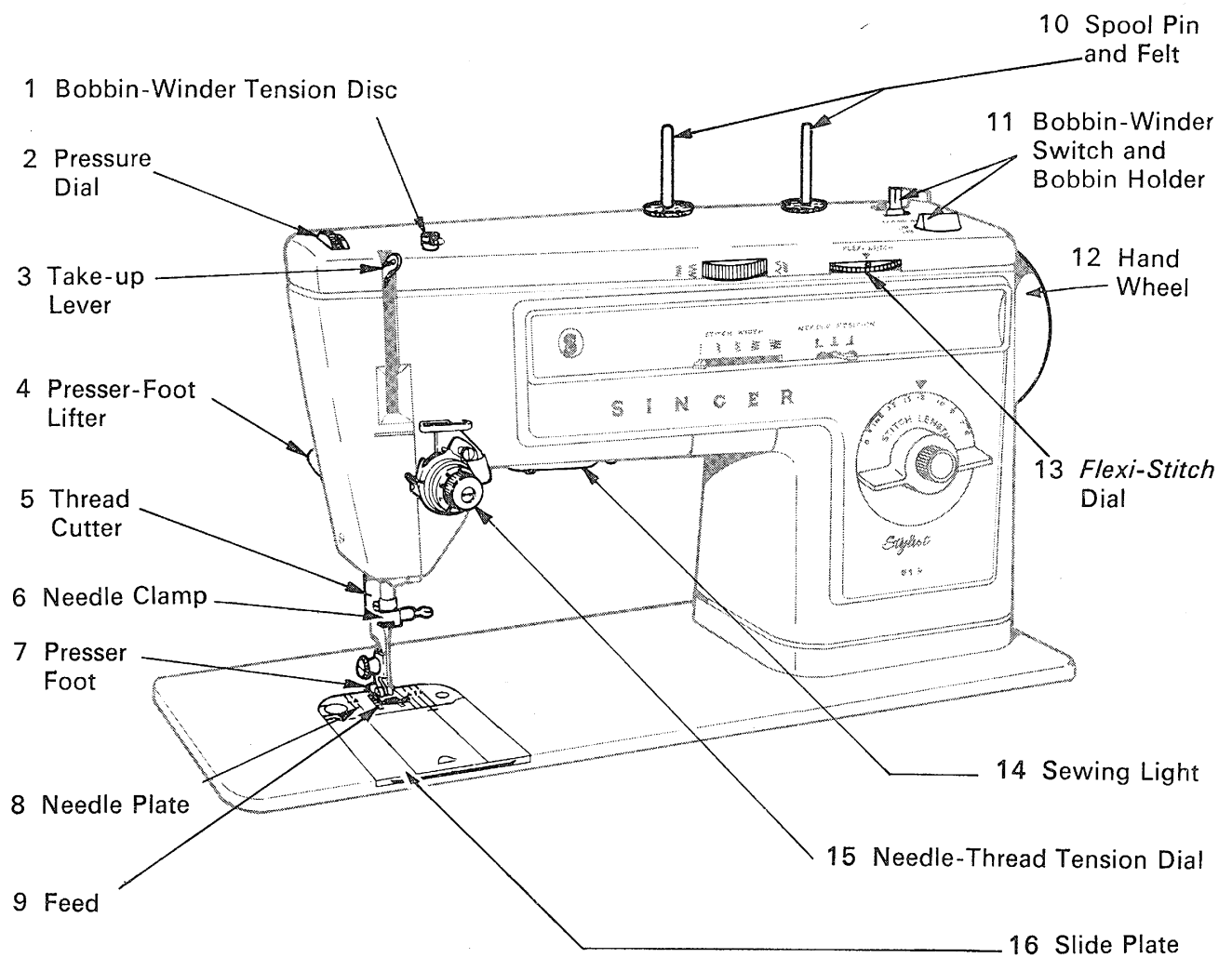





SINGER SEWING MACHINE

and what they do

1. **Bobbin-Winder Tension Disc** regulates thread tension for bobbin winding.
2. **Pressure Dial** regulates presser-foot pressure on fabric. Has eight numbered settings and a special setting for darning.
3. **Take-up Lever** controls flow of needle thread.
4. **Presser-Foot Lifter**, at back of machine, allows you to raise and lower presser foot. High-lift position allows easy placement of bulky fabrics.
5. **Thread Cutter** is built into presser bar for safety and convenience.
6. **Needle Clamp** holds single and twin needles and is designed to eliminate the possibility of inserting needle backwards.
7. **Presser Foot** holds fabric against feed. The feet snap off for quick removal.
8. **Needle Plate** lifts out for easy removal. Guidelines on right *and* left sides extend to slide plate to help you keep seams straight.
9. **Feed** moves fabric under the presser foot.
10. **Spool Pin and Felt**. Pin holds thread spools of various sizes. Felt helps thread unwind smoothly.
11. **Bobbin-Winder Switch and Bobbin Holder** let you fill the bobbin with thread quickly and easily.
12. **Hand Wheel** positions take-up lever and needle. Always turn it towards you.
13. **Flexi-Stitch Dial** sets the machine for *Flexi-Stitch* pattern sewing and varies the balance of *Flexi-Stitch* patterns in order to obtain desired pattern appearance.
Dial must be set on O (off) position when not in use.
14. **Sewing Light** illuminates the sewing area.
15. **Needle-Thread Tension Dial** lets you select just the right tension for your stitch, thread, and fabric. The numbers eliminate guesswork in duplicating settings.
16. **Slide Plate** opens for easy removal and replacement of the bobbin, and raises and lowers the pin that holds the needle plate in place.

PRINCIPAL PARTS (Continued)

17. **Pattern Selector** lets you select plain zig-zag () or blindstitch () zig-zag patterns; also ric-rac () or slant overedge () *Flexi-Stitch* patterns.
18. **Stitch Width Selector** controls the width of zig-zag stitching and positions needle for straight stitching. Use  setting for straight stitching.
19. **Needle-Position Selector** places needle in either left, center or right stitching position. Use center position for straight stitching.
20. **Stitch Control Dial** allows for a variety of stitch lengths, including FINE for zig-zag satin stitching. Has special setting for *Flexi-Stitch* pattern sewing.
21. **Reverse-Stitch Push Button** lets you reverse stitching direction.

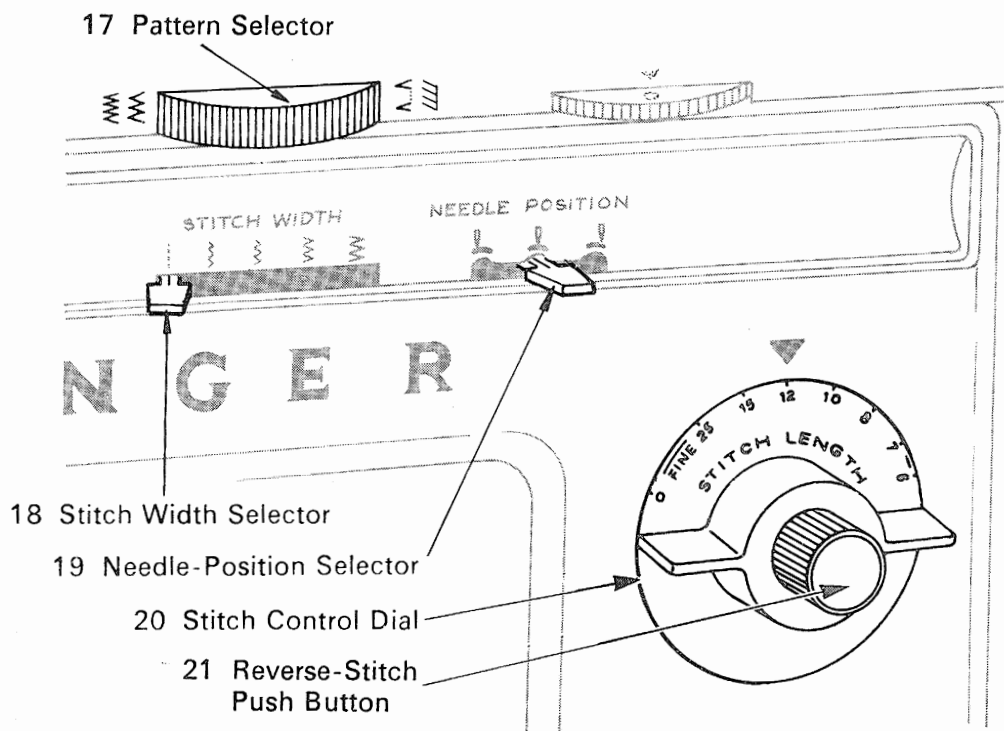

22. Hand Wheel Knob engages hand wheel to sewing mechanism. Loosen knob for bobbin winding.

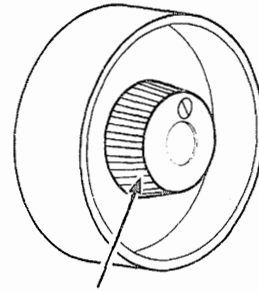

22 Hand Wheel Knob

23. Transparent Bobbin shows thread supply . . . is easily removed for bobbin winding.

23 Transparent Bobbin

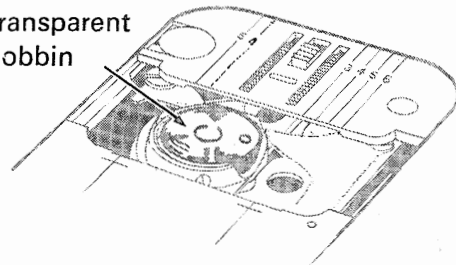

24. Power and Light Switch turns on the power and the sewing light simultaneously.

24 Power and Light Switch

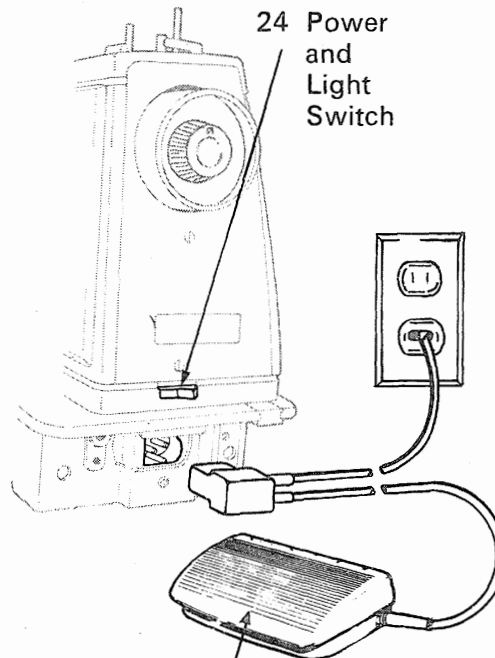

25. Electrical Connections and Speed Controller are designed for convenience and safety.

25 Electrical Connections and Speed Controller

See instructions for connecting machine and operating machine and controller on page 9.

accessories...and when to use them

The accessories that come with your *Stylist* sewing machine will help you to sew with ease and comfort. They are simple to use and place a variety of sewing effects at your fingertips. Additional accessories, listed on page 58, are available for purchase at your Singer Sewing Center.

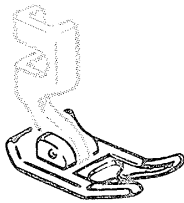

General Purpose
Foot

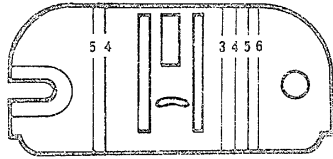

General Purpose
Needle Plate

GENERAL PURPOSE FOOT AND NEEDLE PLATE

The general purpose foot and the general purpose needle plate are in place on the machine. Use them for all utility sewing, with either straight or zig-zag stitching.

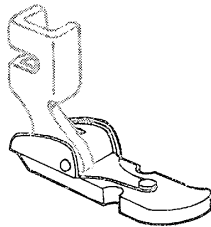

Zipper Foot

ZIPPER FOOT

The zipper foot is used to place stitching close to a raised edge. It can be fitted to the presser-foot shank for use on either right or left side of the needle. Use it for:

- Corded seams
- Tubular cording
- Zipper insertion

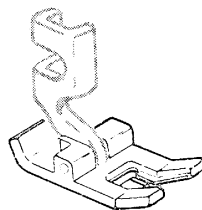

Special Purpose Foot

SPECIAL PURPOSE FOOT

The special purpose foot is used for all kinds of decorative zig-zag stitching. Use this foot for:

- Zig-zag satin stitching
- Ornamental stitching with *Flexi-Stitch* patterns
- Appliqué
- Buttonholes
- Twin-needle stitching

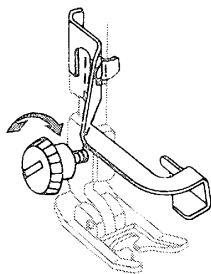

Blindstitch Hem Guide

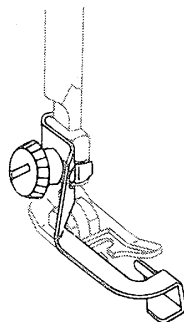

BLINDSTITCH HEM GUIDE

The blindstitch hem guide is used with the general purpose foot to position the hem fold for blindstitch hemming (page 44). To attach, simply loosen presser-foot screw and slip guide between screw and presser-foot shank. Position guide so that it clears both slide plate and presser-foot toe. Tighten screw.

FEED-COVER NEEDLE PLATE

The feed-cover needle plate is used in place of the general purpose needle plate when fabric feeding is not desired. Use it for button sewing (page 31) and free-motion darning (page 51).

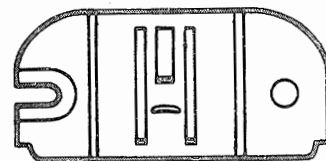

Feed-Cover Needle Plate

CHANGING NEEDLE PLATE

- Raise presser foot. (You do not need to remove the foot.)
- Turn hand wheel toward you until needle is in its highest position.
- Open slide plate with downward finger pressure. Draw plate toward you, opening it *all the way* to raise the needle plate locking pin and unlock the needle plate.
- Place thumb under needle plate and draw plate to the right to remove.
- Insert new needle plate under locking pin and over positioning pin.
- Close slide plate to lower locking pin and secure the needle plate.

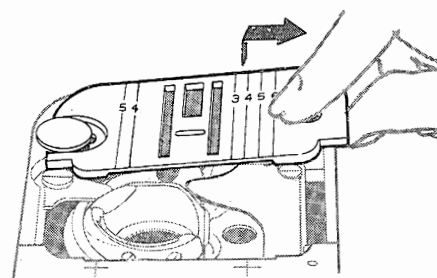
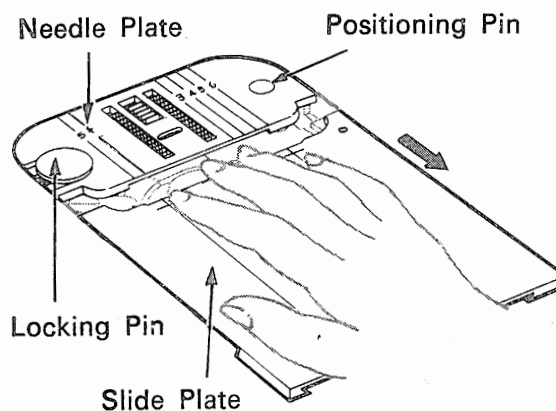

Changing Needle Plate

CHANGING PRESSER FEET

The presser feet that are supplied with your machine snap on and off a common shank. To change the foot :

- Raise presser-foot lifter and turn hand wheel toward you to raise needle to its highest position.
- Press toe of presser foot upward (as far as it will go) and then snap down to remove the foot.
- Center the new presser foot under the shank and lower the presser-foot lifter so that shank fits over the presser-foot pin.
- Press down on presser-foot screw until foot snaps into place.

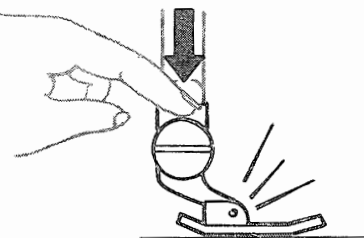
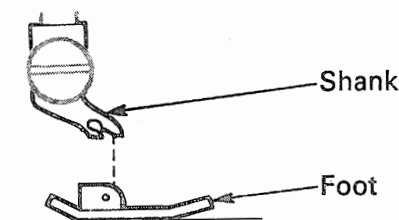

Changing Presser Foot

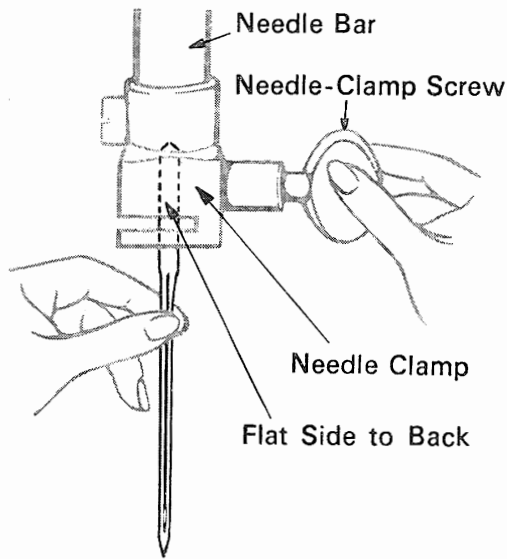
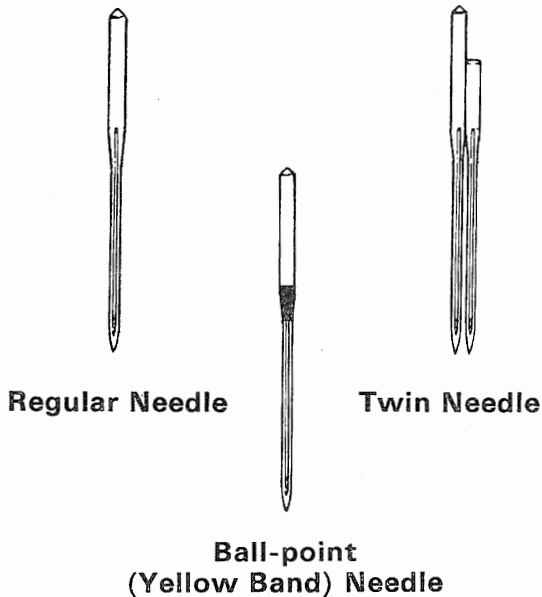

Changing the Needle

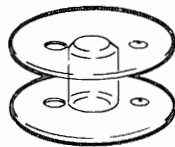

Transparent Bobbin

NEEDLES

- Style # 2020 needles for all-purpose sewing.
- Style # 2045, ball-point (yellow band) needles, for sewing knits and stretch fabrics.
- Style # 2028, twin needle, for decorative twin-needle stitching.

IMPORTANT: *Your SINGER sewing machine has been designed to obtain best results with SINGER needles. You should follow the recommendations in this instruction book on the needle package for correct style and size of needle for different types and weights of fabrics.*

CHANGING THE NEEDLE

The needle clamp is designed so that the needle can only be inserted with the flat side of the needle to the back. To change the needle:

1. Raise needle bar to its highest position, loosen needle-clamp screw, and remove needle.
2. Insert new needle in clamp, with the flat side of the needle to the back; push it up as far as it will go.
3. Tighten needle-clamp screw.

BOBBINS

Transparent, drop-in bobbin, # 172336, shows thread supply at a glance.

GETTING READY TO SEW

preliminary steps

CONNECTING THE MACHINE

Before plugging in your machine, be sure that the voltage and number of cycles indicated on the plate under the hand wheel conform to your electrical power supply.

Push the machine plug into the receptacle at the right end of the machine bed. Then connect the power-line plug to your electrical outlet.

OPERATING MACHINE AND CONTROLLER

To turn on both machine and sewing light, press power and light switch to ON position (red bar on switch will be visible).

- To turn off machine and light, press switch at red bar to OFF position.

CAUTION: *When leaving the machine unattended or before changing needles, presser feet and needle plates, turn off the power and light switch and disconnect the power-line plug from the electrical supply socket.*

This eliminates the possibility of operating the machine by accidentally pressing the speed controller.

To run the machine, press the speed controller. The harder you press, the faster the machine will sew.

To stop the machine from sewing, remove pressure from speed controller.

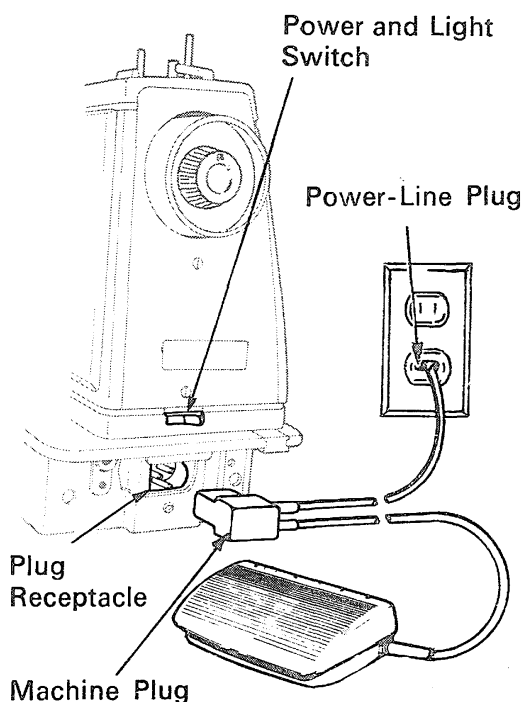

Electrical Connections

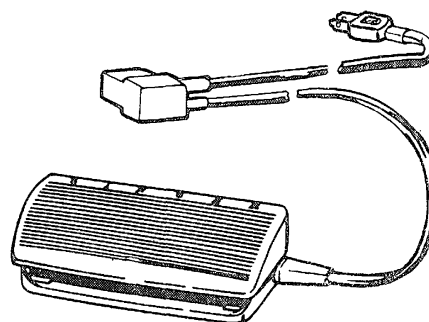
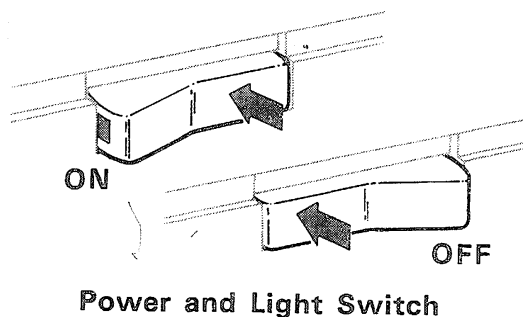

choosing needle and thread

The needle and thread you choose will depend upon the fabric being stitched. The table below is a practical guide to needle and thread selection. Refer to it before starting a sewing project. Be sure to use the same size and type of thread in both needle and bobbin.

FABRIC, THREAD AND NEEDLE TABLE

Fabric	Thread	Needles	
		Type	Size
DELICATE — tulle, chiffon, fine lace, organza	Fine polyester, nylon, and cotton thread	STYLE 2020 (15 × 1)	9
LIGHTWEIGHT — batiste, organdy, jersey, voile, taffeta, crepe, chiffon, velvet, plastic film	50 mercerized cotton "A" silk Polyester thread Cotton-wrapped polyester	STYLE 2020 (15 × 1)	11
MEDIUM WEIGHT — gingham, percale, piqué, linen, chintz, faille, satin, fine corduroy, velvet, suitings, deep-pile fabrics, vinyl	50 mercerized cotton 60 cotton "A" silk Polyester thread Cotton-wrapped polyester	STYLE 2020 (15 × 1)	14
MEDIUM HEAVY — gabardine, tweed, sailcloth, denim, coatings, drapery fabrics, vinyl, deep-pile fabrics	Heavy-duty mercerized cotton 40 to 60 cotton Polyester thread	STYLE 2020 (15 × 1)	16
HEAVY — overcoatings, denim, upholstery fabrics, canvas	Heavy-duty mercerized cotton 24 to 40 cotton Polyester thread	STYLE 2020 (15 × 1)	18
ALL WEIGHTS — decorative straight stitch topstitching in woven fabrics	"D" silk † (Buttonhole twist)	STYLE 2020 (15 × 1)	16 or 18
KNIT, WOVEN STRETCH and ELASTIC FABRICS — polyester doubleknit, spandex, nylon tricot, ciré tricot, jersey, panné velvet	"A" nylon 50 mercerized cotton "A" silk Cotton-wrapped polyester	STYLE 2045 Ball-Point (Yellow Band)	14
LEATHER — suede, kidskin, capeskin, lambskin, lined leathers	50 mercerized cotton Polyester thread "A" silk Cotton-wrapped polyester	STYLE 2032 (15 × 2)	11 14 16
LIGHT and MEDIUM WEIGHTS — decorative twin-needle stitching in woven fabrics	50 mercerized cotton	STYLE 2028 (twin)	14

threading your sewing machine

Like all sewing machines that produce what is called a "lockstitch", your *Stylist* sewing machine sews with two threads. The upper thread comes from the spool and is threaded through the eye of the needle. The lower thread comes from the bobbin, the small transparent spool that you wind using the machine. It is best to wind the bobbin before threading the needle.

THE BOBBIN THREAD

Winding the Bobbin

- Raise the presser foot and turn the hand wheel toward you until needle is at its highest position.
- Loosen the hand wheel knob by turning it toward you with the right hand while holding the hand wheel with the left hand.
- Open slide plate to make bobbin accessible.
- Lift out bobbin and close slide plate to make sure needle plate is secure while winding.

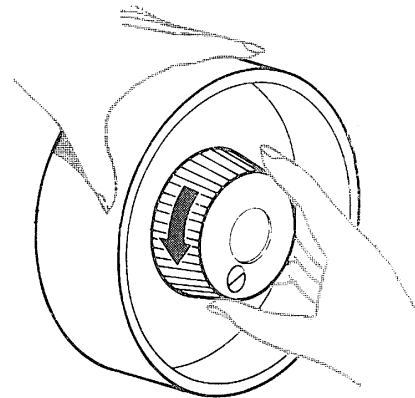

Loosening Hand Wheel Knob

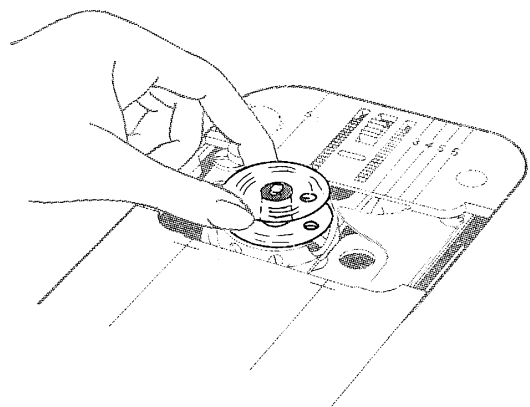

Removing Bobbin

THE BOBBIN THREAD (Continued)

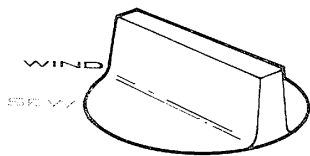
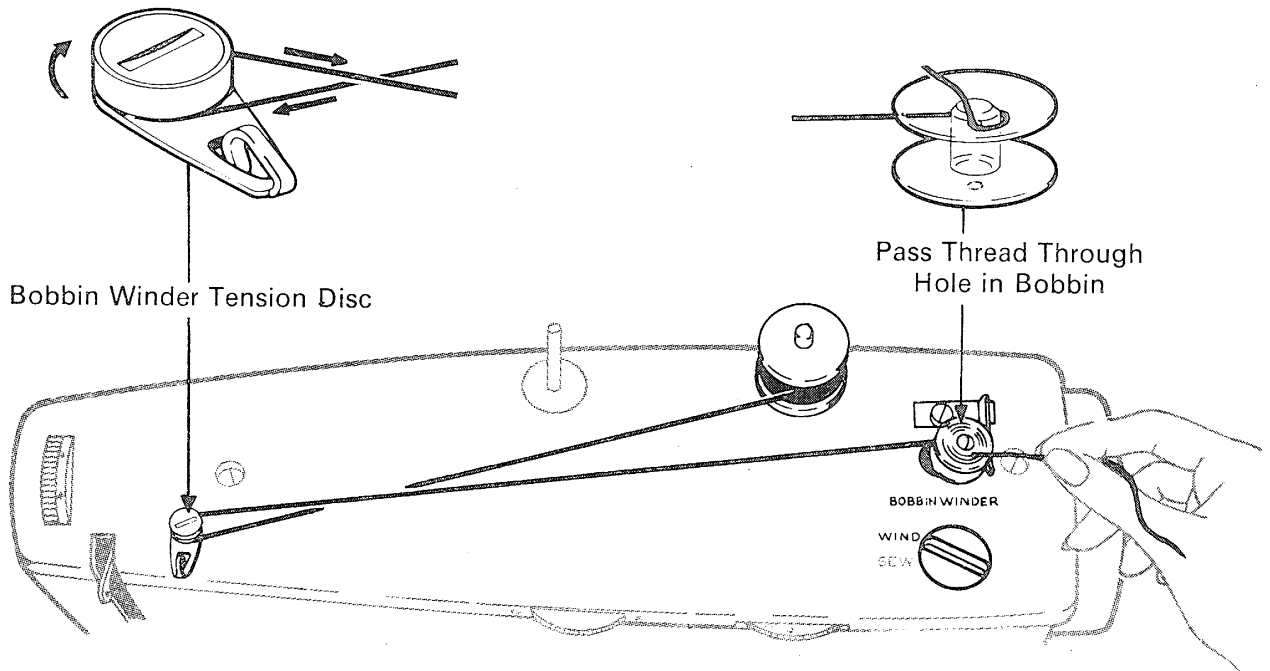

Bobbin Winder Switch

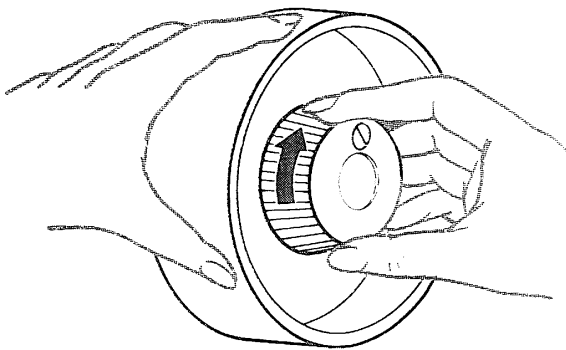

Tightening Hand Wheel Knob

- Place thread spool on spool pin over felt. Lead thread around bobbin winder tension disc and through small hole in bobbin (from the inside).
- Place bobbin on holder and turn bobbin winder switch to WIND.
- Hold thread as shown and start the machine, winding at moderate speed. Cut off thread end when winding is well under way.
- When required amount of thread has been wound (winding will stop by itself when bobbin is full), stop the machine and cut connecting thread.
- Turn bobbin winder switch to SEW and remove bobbin from holder.
- Tighten hand wheel knob.

THREADING THE BOBBIN CASE

1. Open slide plate. Hold bobbin so that thread unwinds in direction shown, and put bobbin in bobbin case.

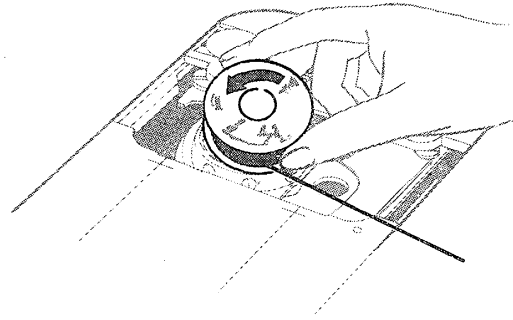

2. Pull thread into notch, draw it under tension spring and back into slot.

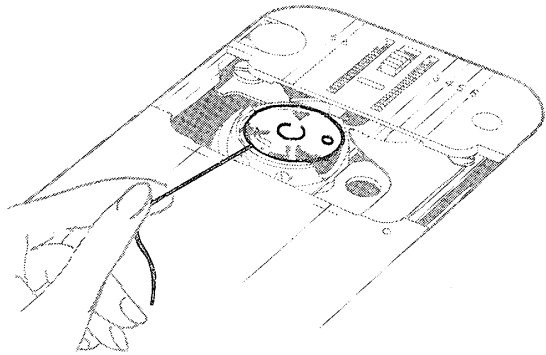

3. Draw about three inches of thread diagonally across the bobbin.

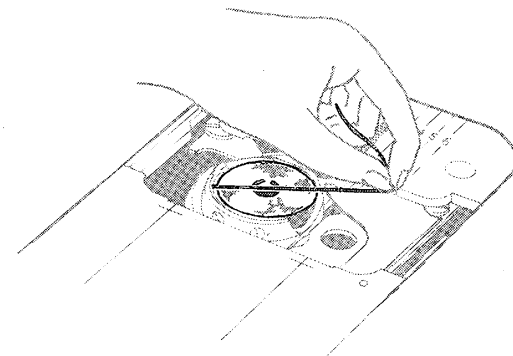

4. Close slide plate allowing thread to enter slot between the needle plate and slide plate.

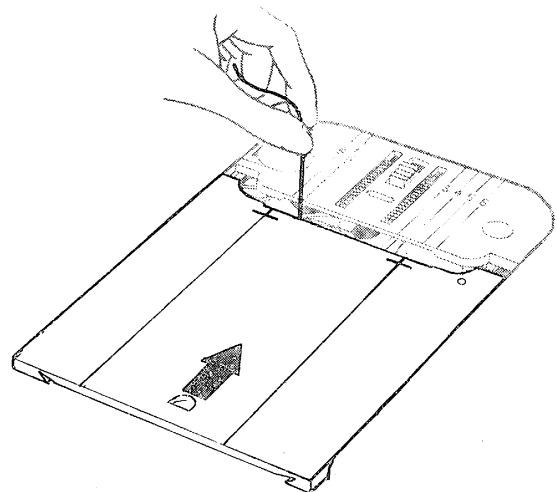

THE NEEDLE THREAD

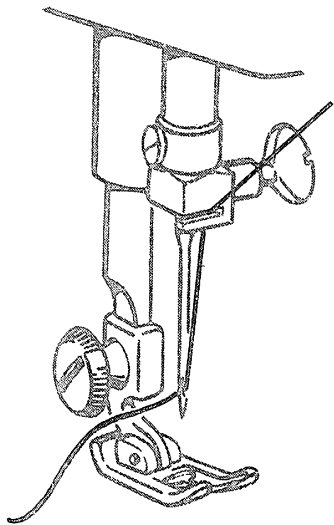
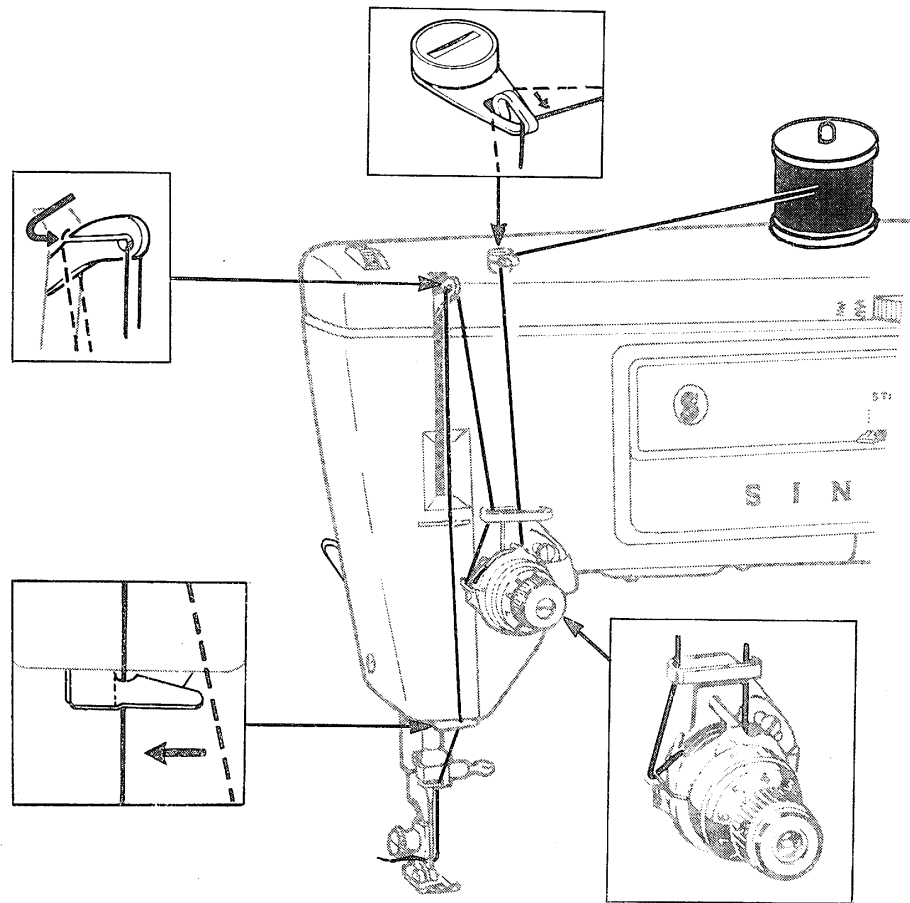

Threading the Needle

1. Turn hand wheel toward you to raise needle to its highest position *and raise presser foot to release the tension discs.*
2. Place spool of thread on spool pin over felt and lead thread through all threading points shown.
 - Thread take-up lever from back to front, guiding thread down over top of lever and then up into eyelet.
 - Thread needle from front to back, drawing about three inches of thread through eye of needle.

RAISING THE BOBBIN THREAD

Now that you have wound the bobbin and threaded the needle, you will need to raise the bobbin thread through the needle hole in the needle plate.

1. Hold needle thread lightly with left hand and turn hand wheel slowly toward you so that needle enters hole in needle plate.

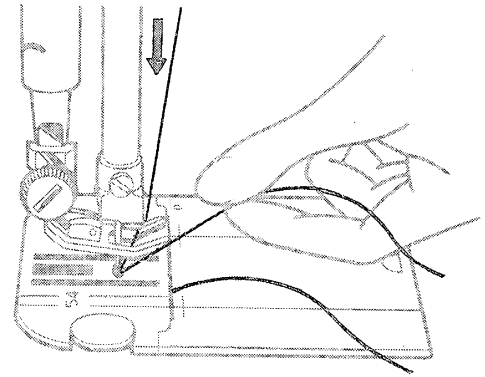

2. Continue turning hand wheel and holding needle thread until needle rises. Tighten your hold on the needle thread and bring up bobbin thread in a loop.

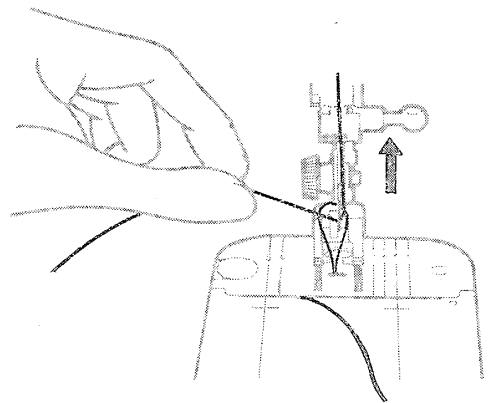

3. Open the loop with your fingers.

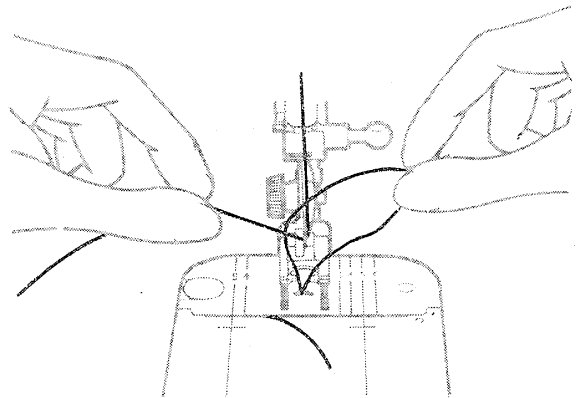

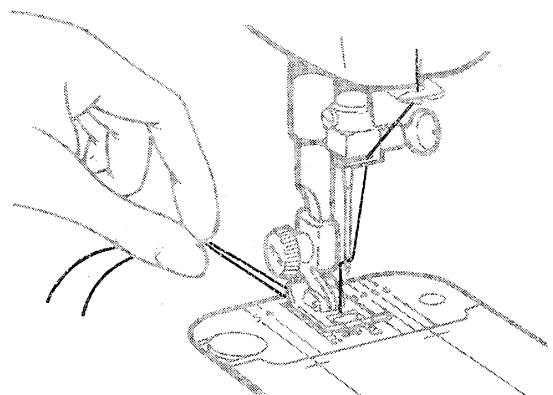

4. Place both needle and bobbin threads under presser foot, and draw to back of machine.

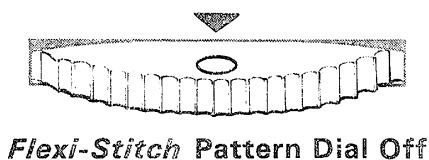

... You are now ready to sew

STRAIGHT STITCHING



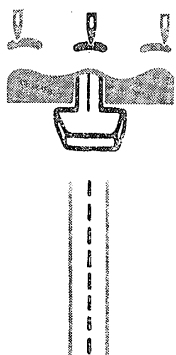

- Flexi-Stitch Pattern Dial: ○ (Off)
- Pattern Selector: Any setting
- Needle Position: 
- Stitch Width: 
- Stitch Length: To suit fabric
- General Purpose Needle Plate
- General Purpose Foot



Before you move the selectors to set your sewing machine for straight stitching, turn the hand wheel toward you until the needle is above the needle plate.

SETTING THE MACHINE

- Turn *Flexi-Stitch* pattern dial to off position ○.
- Move needle position selector to  (center).
- Set stitch width selector on  .

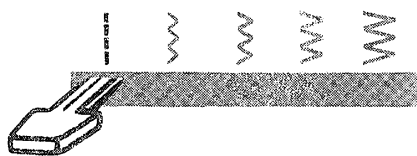

STARTING TO SEW

- Place needle and bobbin threads under presser foot and draw to back of machine.
- Position the needle in the fabric where desired for stitching start.
- Lower the presser foot and start the machine.

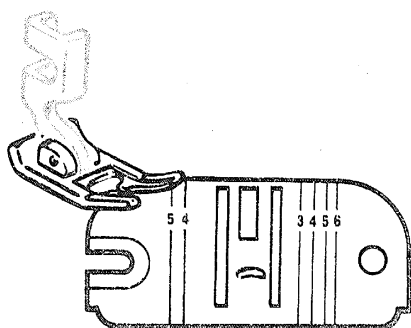

To sew perfectly on a wide variety of fabrics, adjust stitch length, pressure and thread tension as instructed on the following pages.

For information on straight stretch stitching turn to page 26.

adjusting selectors for your fabric

ADJUSTING STITCH LENGTH

The stitch length dial regulates the length of stitches. The numbers on the dial express stitch length in stitches per inch; the higher the number, the shorter the stitch. Generally, shorter stitches are best for lightweight fabric; longer ones for heavy fabric. The FINE area is used for the adjustment of zig-zag satin stitching.

Setting the Selector

- Turn dial so that the stitch length desired is positioned under the ▼ symbol on the control panel.
- To *shorten* the stitch length, turn the dial clockwise to a higher number.
- To *lengthen* the stitch, turn the dial counterclockwise to a lower number.

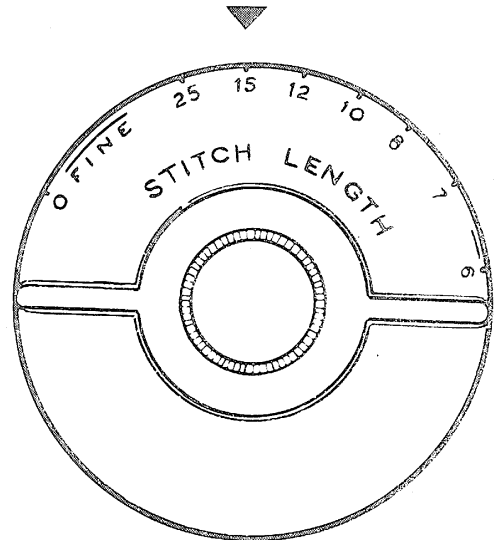

Stitch Length Dial

For reverse stitching, press the reverse-stitch push button (located in the center of the dial) in as far as it will go and hold in place (the button can be pushed in while the machine is sewing). Release pressure on the push button to return to forward stitching.

(For detailed instructions on adjusting the stitch length for zig-zag satin stitching, see page 25.)

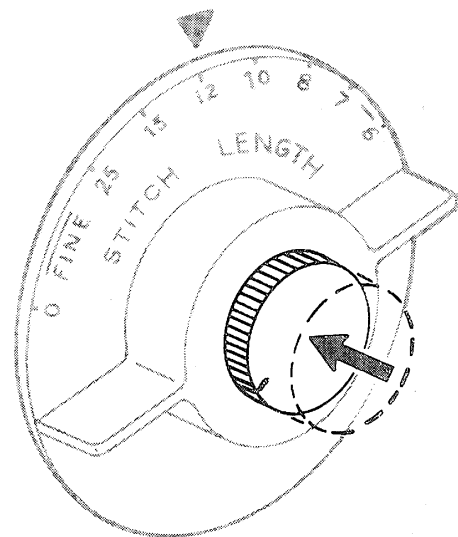

Reverse Stitching

STRAIGHT STITCHING (Continued)

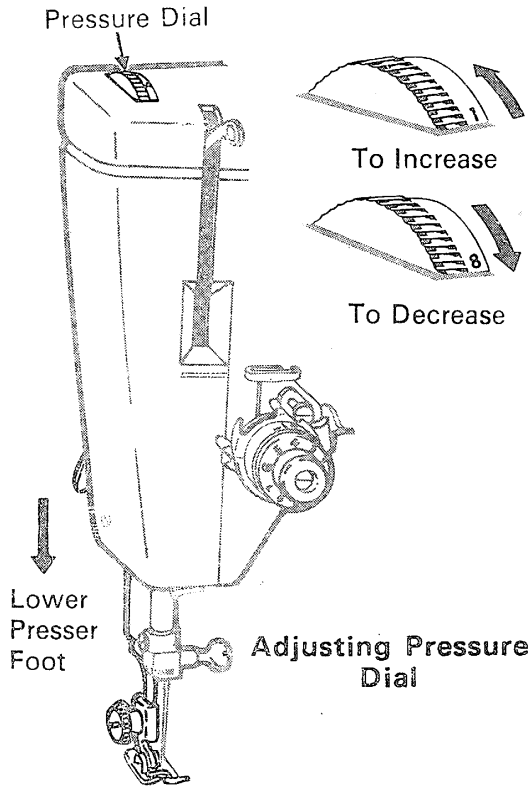

ADJUSTING PRESSURE

Numbered settings on pressure dial will assist you in obtaining correct pressure for fabric you are using. Setting 4 is an all purpose setting for sewing a wide variety of fabrics of different weights and textures. Settings above and below setting 4 are also provided. When you need extra control, regulate the setting to heavier or lighter pressure to suit fabric being sewn.

When darning without an embroidery hoop, set dial at lowest setting, D. See page 50 for instructions.

Lower presser foot before setting pressure.

- To *increase* pressure, turn dial to higher number.
- To *decrease* pressure, turn dial to lower number.

REGULATING THREAD TENSION

Correct tension is important because too much or too little will weaken your seams or cause your fabric to pucker. Make a test sample with fabric and thread you plan to use and examine it. A perfect stitch will have needle and bobbin threads locked between two layers of fabric with no loops on top or bottom and no puckers.

The tension dial regulates the degree of tension on your needle thread. Set it according to the type of thread and fabric you use. The numbers on the dial eliminate guesswork in duplicating settings.

If the stitches in your test sample look loose, increase needle-thread tension. If the fabric puckers, decrease tension.

- To *increase* tension, turn dial to higher number.
- To *decrease* tension, turn dial to lower number.

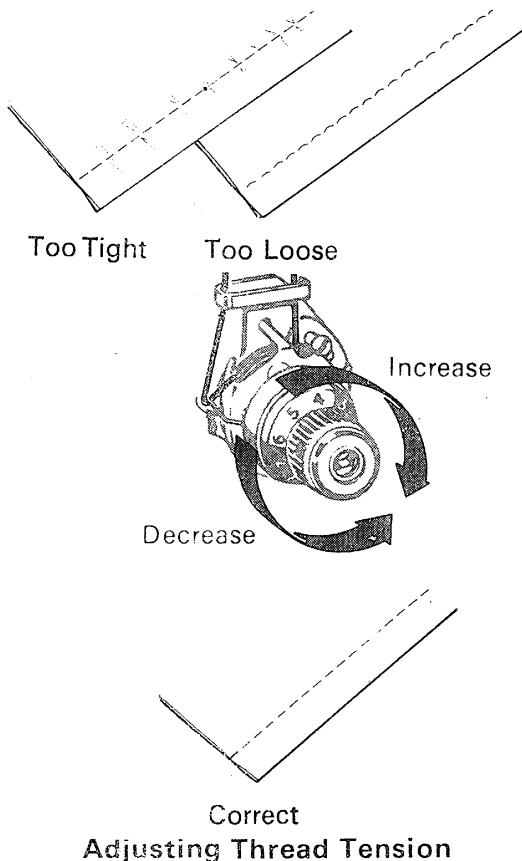

sewing a seam

PIN BASTING

Pin basting is a time-saver and can be used when you sew easy-to-handle fabric. Use fine pins and place them:

- On top of the fabric (never on the underside in contact with the feed).
- At right angles to the stitching line.
- Just nipping into the fabric at the stitching line (never extending under both sides of the presser foot).

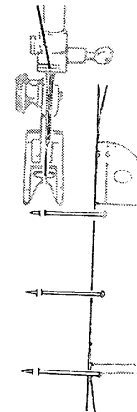

STARTING A SEAM

1. Set stitch length dial for desired number of stitches per inch.
2. With presser foot up, align fabric with appropriate seam guideline on needle plate (as described on the following page). Position needle in fabric about $\frac{1}{2}$ inch from the back edge.
3. Lower presser foot. Backstitch to the edge of the fabric for reinforcement by pushing in the reverse-stitch push button located in the center of the stitch length dial. Hold the button until the stitches reach the edge of the fabric and then release for forward stitching.

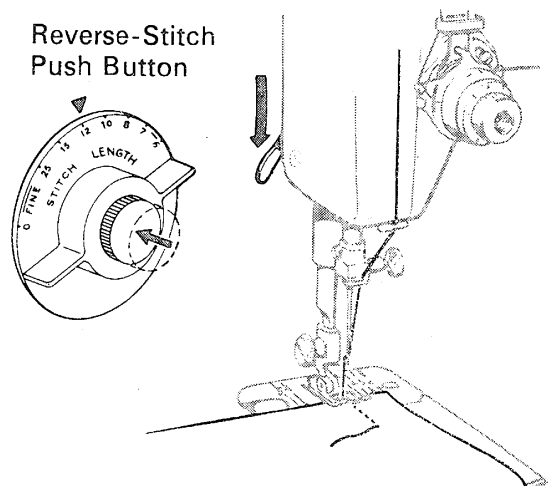
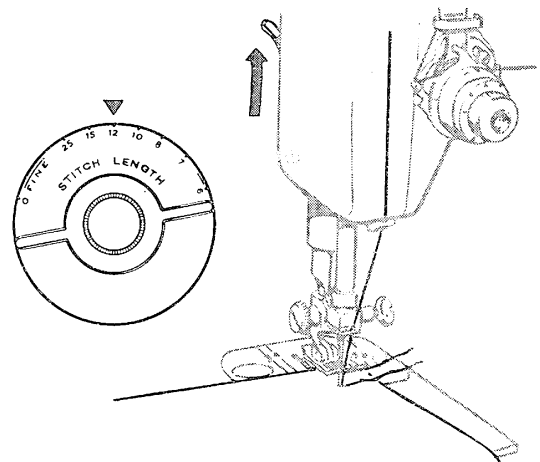

STRAIGHT STITCHING (Continued)

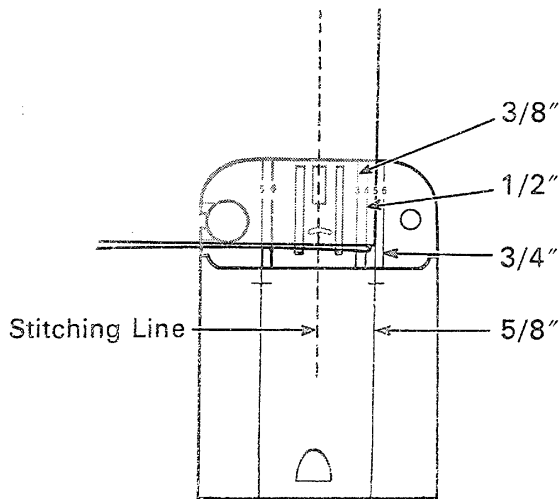

Using Guidelines

KEEPING THE SEAM STRAIGHT

As you stitch, use one of the numbered lines on the needle plate as a guide for keeping the seams straight. Numbers indicate distance, in eighths of an inch, from the needle. If you want a $\frac{5}{8}$ -inch seam, for example, keep the right-hand edge of your fabric on the number 5 guideline.

TURNING SQUARE CORNERS

To turn a square corner $\frac{5}{8}$ inch from the fabric edge, you need not measure or mark the seam. Simply use the crosslines on the slide plate.

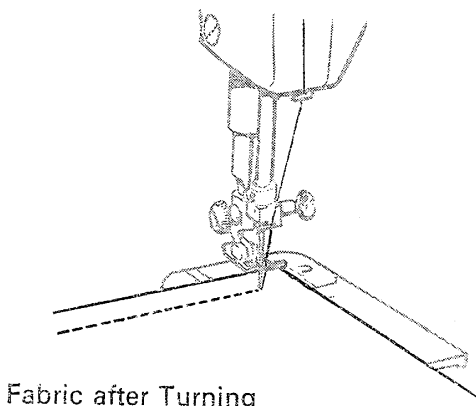
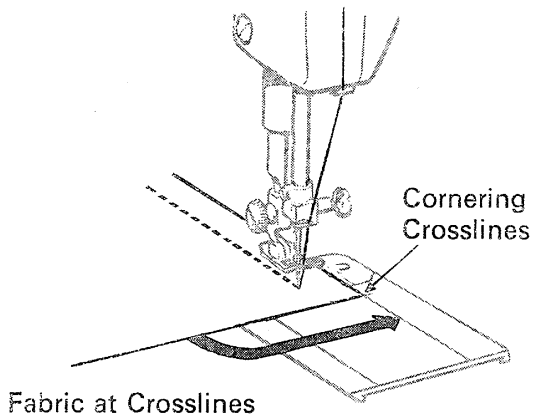

Pivoting at Corner

- Line up your fabric with right or left guideline 5 on the needle plate. Stitch seam, slowing speed as you approach corner.
- Stop stitching, with the needle down, when the bottom edge of the fabric reaches the cornering crosslines on the slide plate.
- Raise presser foot and turn fabric on needle, bringing bottom edge of fabric in line with guideline 5.
- Lower the presser foot and stitch in new direction.

GUIDING AND SUPPORTING THE FABRIC

Most fabrics need only to be *guided* in front of the presser foot. Some fabrics, however, require *support* while being stitched. Filmy sheers, panné velvet, and tricots, for example, need to be held taut in front and back of the presser foot while being sewn.

For information on sewing knit and stretch fabrics with zig-zag stitching, refer to page 35.

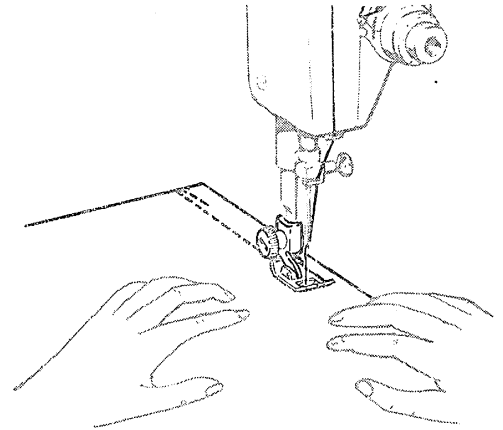

Guiding Fabric

REINFORCING END OF SEAM

1. Stitch to the fabric edge.
2. Push in reverse-stitch push button and backstitch $\frac{1}{2}$ inch to reinforce the end of the seam.
3. Raise presser foot and remove fabric by drawing it to the back and left.
4. Cut threads on thread cutter at rear of presser bar.

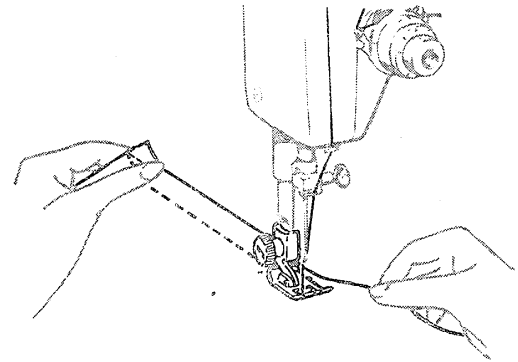

Supporting Fabric

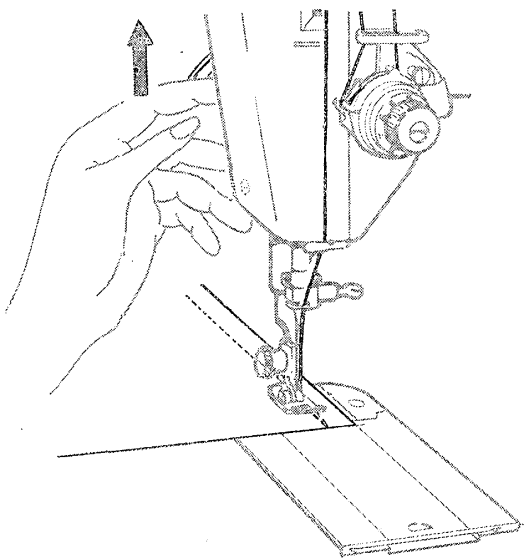

Ending a Seam

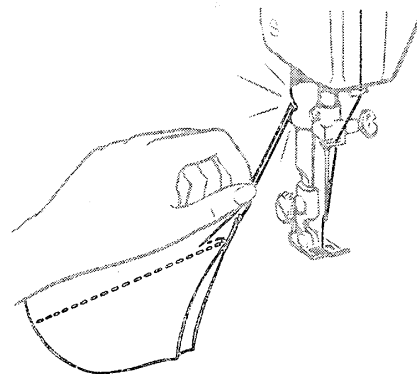

ZIG-ZAG STITCHING

The zig-zag stitches built into your sewing machine include basic zig-zag patterns and *Flexi-Stitch* patterns. Basic zig-zag patterns and their selector settings are shown below; information on *Flexi-Stitch* patterns starts on page 26. You will find instructions for both decorative and practical uses of these patterns in the section called "Sewing the Professional Way" beginning on page 35.

BASIC ZIG-ZAG PATTERNS



Plain Zig-Zag Stitch. Used for buttonholes, button sewing, bar tacks and appliqué.



Blindstitch. Indispensable for finishing hems and seam edges and for zipper insertion.

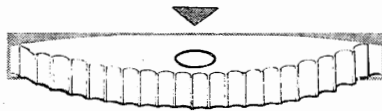

Flexi-Stitch Dial Off

TO SEW A ZIG-ZAG STITCH PATTERN

- Turn *Flexi-Stitch* dial to off setting 0.
- Set pattern selector for stitch desired.
- Adjust stitch length, stitch placement, stitch width and needle-thread tension as instructed on the following pages.



For Zig-Zag Stitching

SETTING PATTERN SELECTOR

Set the stitch width on  before moving pattern selector dial.

The pattern selector, located above the stitch width selector on the front of the machine, controls stitch selection.



For Blindstitching

Pattern Selector

For Plain Zig-Zag Stitching

- Move selector dial toward  .

For Blindstitching

- Move selector dial toward  .

Before moving stitch width and needle position selectors make sure needle is above fabric.

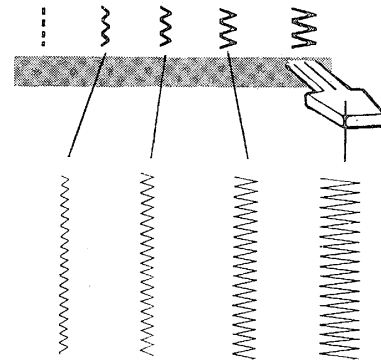

ADJUSTING WIDTH OF DESIGN

To produce a zig-zag stitch pattern, move the stitch width selector from straight stitch setting | to any zig-zag setting to the right. Stitch width is increased as the selector is moved to the right.



Adjusting Stitch Width

ADJUSTING STITCH PLACEMENT

Most of your basic zig-zag stitching will be done in center () needle position. Left () and right () settings are used for special stitch placement, as in buttonhole sewing, button sewing, and twin-needle work.

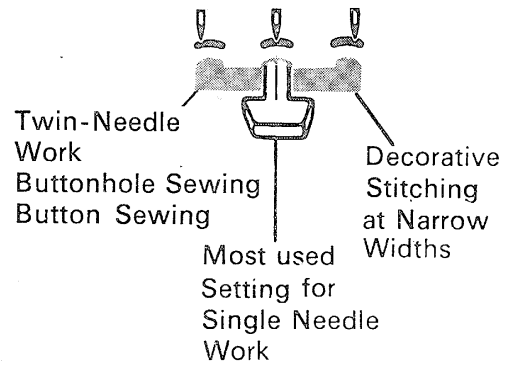

Adjusting Stitch Placement

ADJUSTING NEEDLE-THREAD TENSION

Zig-Zag stitching requires less needle-thread tension than straight stitching. Make a test sample with the fabric and thread you plan to use so that you can adjust the tension properly. The stitches should lie flat against the fabric without causing the fabric to pucker.

If the stitches are not flat and the fabric is puckered, reduce needle-thread tension by turning the dial to a lower number.

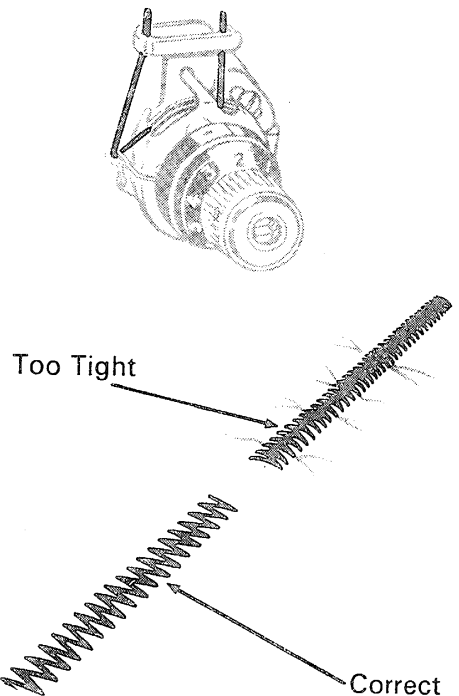

Adjusting Needle-Thread Tension

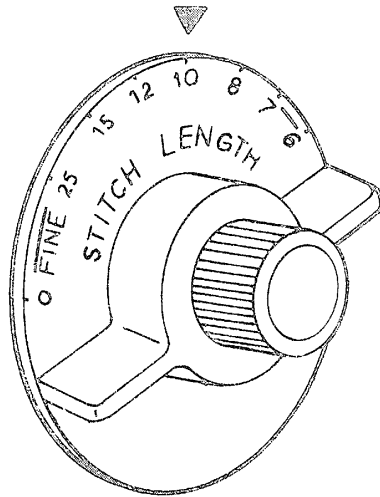

Stitch Length Dial

ADJUSTING STITCH LENGTH

Any stitch length setting from 6 to 25 will give you an open zig-zag stitch of the basic zig-zag stitch pattern you select. The lower the number, the more open, or farther apart, your stitches will be. The FINE stitch area, between 0 and 25 on the dial, is used for adjusting zig-zag satin stitching (see next page for specific instructions).

When using the plain zig-zag or blindstitch patterns, be sure the *Flexi-Stitch* dial is in off position O.

ADJUSTING PRESSURE AND CHOOSING ACCESSORIES

Turn to page 18 under "Straight Stitching" for instructions on adjusting pressure.

For information on choosing accessories, refer to pages 6 and 7 and to detailed instructions for sewing with zig-zag stitch patterns included in the section called "Sewing the Professional Way" that starts on page 35.

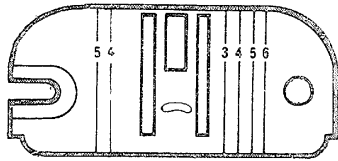

General Purpose Needle Plate

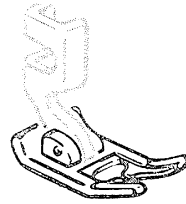

General Purpose Foot

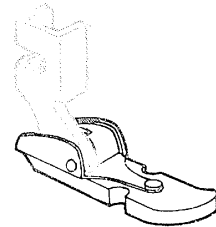

Zipper Foot

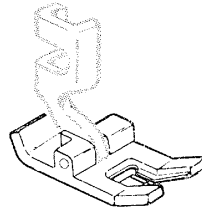





Special Purpose Foot

satin stitching

Satin stitching—a series of closely spaced zig-zag stitches that form a smooth, satin-like surface—is useful for both practical and decorative work.

When you wish to produce a satin stitch for appliqué or bar tacks, for example, make a test sample first so that you can adjust the stitch length and thread tension properly. Soft fabrics may require a backing to ensure firm satin stitching. Crisp lawn or organdy is suitable for this purpose.

ACCESSORIES AND SELECTOR SETTINGS

- Flexi-Stitch Dial: 0
- Pattern Selector:  (plain zig-zag)
- Needle Position: 
- Stitch Width:  to 
- Stitch Length: FINE (25 or above)
- General Purpose Needle Plate
- Special Purpose Foot
- Pressure: 2 or 3

Adjusting Stitch Length

1. Turn stitch length selector dial to 25 (the beginning of FINE area).
2. Run machine at a slow speed.
3. Gradually turn the stitch length dial clockwise until stitches are closely spaced and form a smooth surface.

Adjusting Thread Tension

Satin stitching requires less tension than straight stitching or open zig-zag stitching. Furthermore, the wider the stitch, the lighter the tension on the thread must be. Notice the stitching on your sample. If the fabric is puckered, lower the needle-thread tension by turning the tension dial to a lower number.

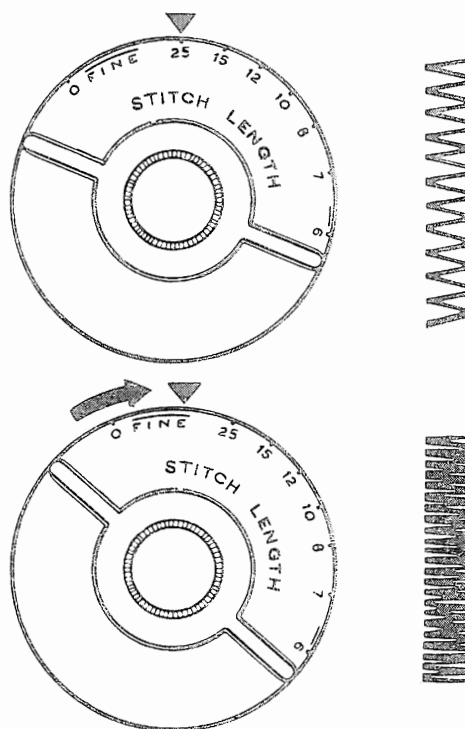

Adjusting Stitch Length

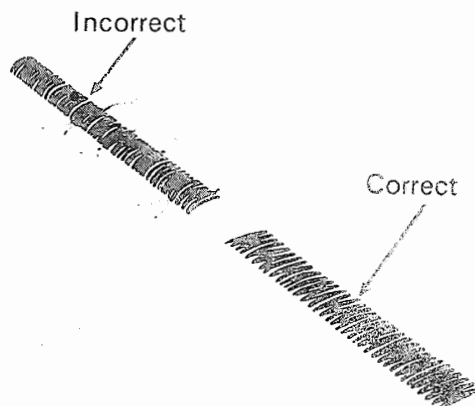
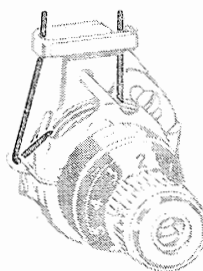

Adjusting Thread Tension

Flexi-Stitch patterns

With your *Stylist* sewing machine you can sew three *Flexi-Stitch* patterns. Instructions for both decorative and practical uses of these patterns begin on page 35.

FLEXI-STITCH PATTERNS

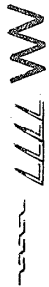

Ric-Rac Stitch. An open, reinforced zig-zag stitch for heavy-duty stretch sewing and decorative work.

Slant Overedge Stitch. Lets you seam and overedge in one operation.

Straight Stretch Stitch. A triple straight stitch, indispensable for seaming knit, stretch, and elasticized fabric.

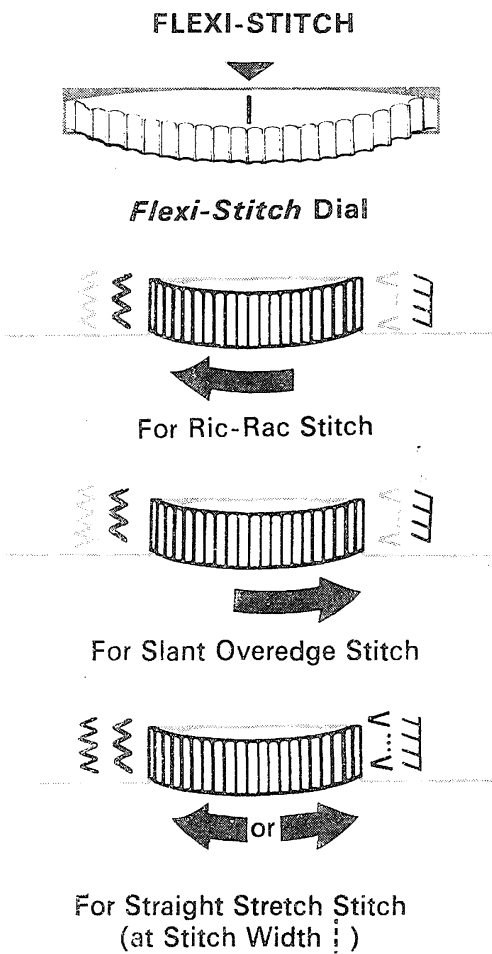

Setting Pattern Selector

To Sew a *Flexi-Stitch* Pattern Use Red Selector Settings

- Set *Flexi-Stitch* dial on red 1 .
- Set pattern selector for desired stitch.
- Set stitch control dial on red 1 .
- Adjust stitch placement, stitch width, thread tension, and stitch balance as instructed on the following pages.

Setting Stitch Pattern Selector

Set the stitch width selector on 1 before moving the pattern selector dial.

For Ric-Rac Stitch

- Move pattern selector to .

For Slant Overedge Stitch



- Move pattern selector to .

For Straight Stretch Stitch

- Any pattern selector setting at stitch width 1 .

Before moving needle position and stitch width selectors make sure needle is above fabric.



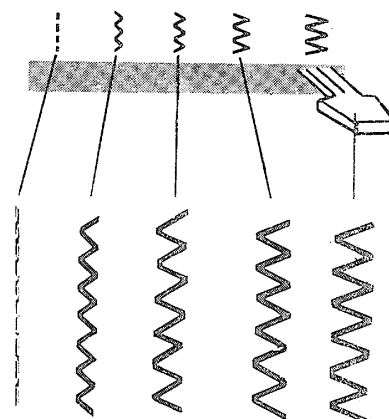

ADJUSTING WIDTH OF DESIGN

To produce a *Flexi-Stitch* pattern, the stitch width selector must be moved from the straight-stitch setting  to a setting from  to . Stitch width is increased as the selector is moved to the right.



Adjusting Width of Design

ADJUSTING STITCH PLACEMENT

Flexi-Stitch patterns can be sewn in either  (left),  (center) or  (right) needle positions. Center needle position  is recommended.

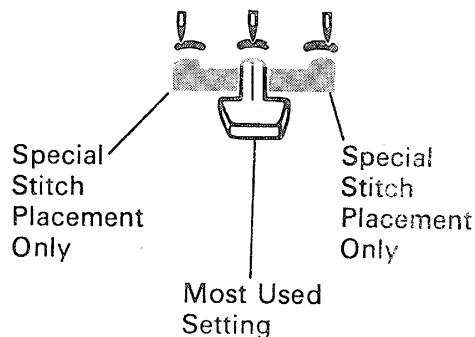

Adjusting Stitch Placement

ADJUSTING NEEDLE-THREAD TENSION

Make a test sample with the fabric, thread, and presser foot you plan to use so that you can adjust tension to suit the stitch pattern you have chosen.

For your test sample, set the tension dial on 3 or 4. Notice the stitching; if the fabric puckers, decrease tension by turning the dial to a lower number. Sew at moderate speed.

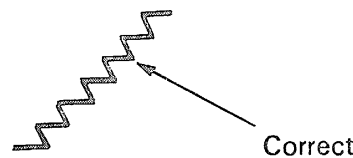
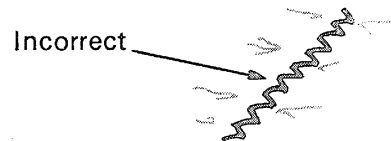
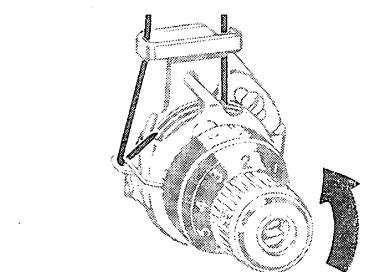

Adjusting Needle-Thread Tension

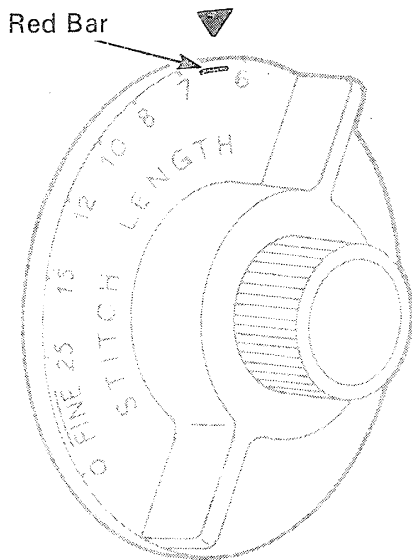

FLEXI-STITCH PATTERNS (Continued)



Stitch Length Dial

SETTING STITCH LENGTH DIAL

When you use a *Flexi-Stitch* pattern, stitch length is controlled with a single setting of the stitch length dial.

To set, turn dial until red bar  is centered under the  symbol on the control panel.

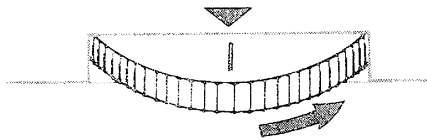
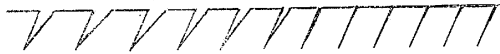

NOTE: Stitching *cannot* be reversed when the *Flexi-Stitch* dial is on red *Flexi-Stitch* pattern setting.

Incorrect Correct



Turn Dial to Right to Bring Stitches Together

ADJUSTING STITCH BALANCE

You may need to adjust the *Flexi-Stitch* dial when using a *Flexi-Stitch* pattern in order to achieve the correct pattern appearance. Before you move the *Flexi-Stitch* dial from its neutral position (red bar  centered under ), make a test sample. If adjustment is required, stitch slowly and move the dial as you sew.

- Turn the dial to the right to bring stitches of the pattern together.
- Turn the dial to the left to separate stitches of the pattern.

Incorrect Correct

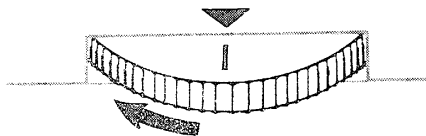
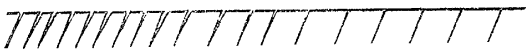

Turn Dial to Left to Separate Stitches

Adjusting Stitch Balance

ADJUSTING PRESSURE AND CHOOSING ACCESSORIES

Turn to page 18 under "Straight Stitching" for instructions on adjusting pressure.





For information on choosing accessories refer to detailed instructions for sewing with *Flexi-Stitch* patterns included in the section called "Sewing the Professional Way", which starts on page 35.

TWIN-NEEDLE STITCHING

By using a twin needle, you can produce two parallel, closely spaced, decorative lines of stitching simultaneously. You can use either one or two colors of thread, and you can choose either a straight-stitch, zig-zag stitch, or blindstitch setting.

SETTING THE MACHINE

Straight Stitching

- Flexi-Stitch Dial:  (Off)
- Pattern Selector: Any setting
- Needle Position:  or  only
- Stitch Width: 
- Stitch Length: Optional
- General-Purpose Needle Plate
- General-Purpose Foot

Zig-Zag Stitching

- Flexi-Stitch Dial:  (Off)
- Pattern Selector:  (for plain zig-zag) or  (blindstitch)
- Needle Position:  only
- Stitch Width: See illustrations at right
- Stitch Length: Optional
- General-Purpose Needle Plate
- General-Purpose Foot (Open Stitching)
- Special-Purpose Foot (Satin Stitching)

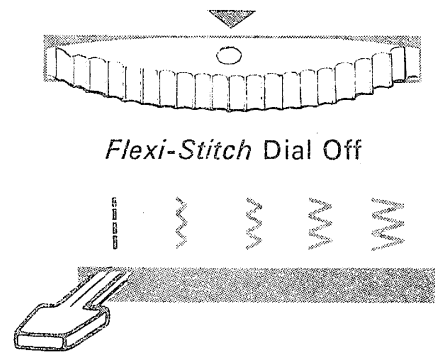

Flexi-Stitch Dial Off

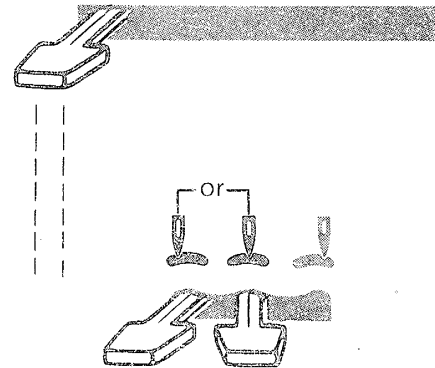

Straight Stitching

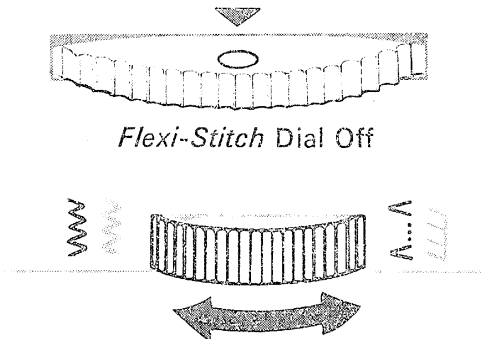

Flexi-Stitch Dial Off

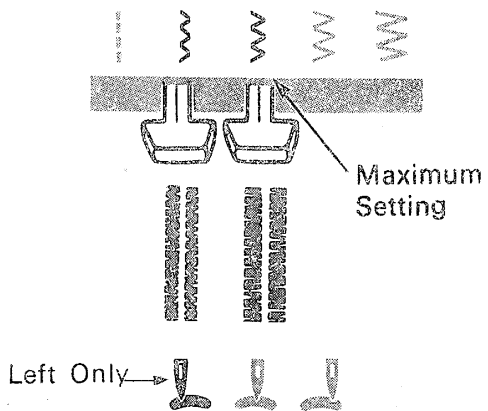

Zig-Zag Stitching

TWIN NEEDLE STITCHING (Continued)

Use SINGER* Twin Needle Style# 2028 (size 14)

INSERTING THE TWIN NEEDLE

Before inserting the twin needle, make sure that the needle position selector is set at  (left) and the stitch width does not exceed the settings shown on page 29.

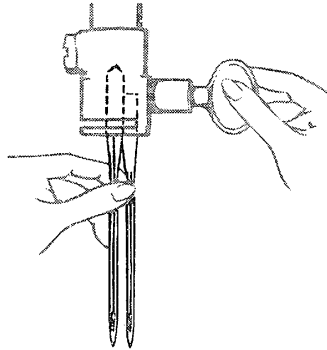

To insert the twin needle, simply raise needle to highest point and loosen the needle-clamp screw. Remove single needle and insert the twin needle in its place. Tighten needle-clamp screw securely.

threading for twin-needle stitching

For best results, use No. 50 mercerized cotton thread.



Thread the machine in the same manner as for single-needle stitching except:

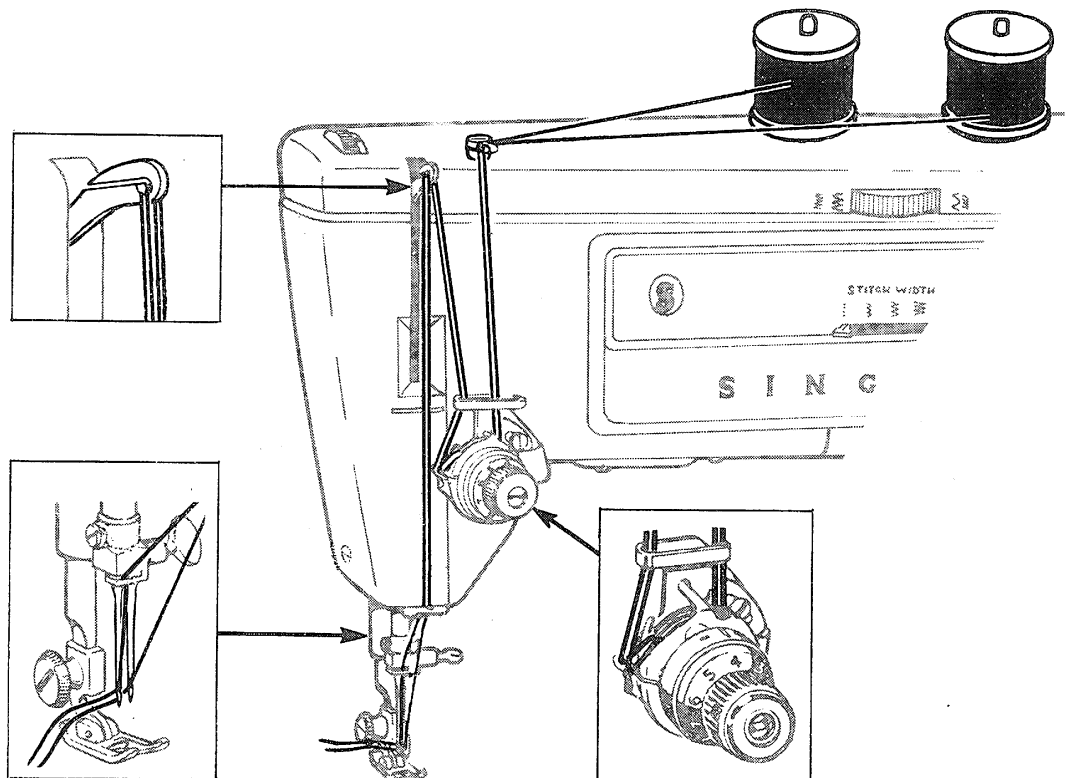



1. Be sure that threads are separated by center tension disc as they pass around tension assembly.
2. Carry only one thread through the last guide before the needle.







BUTTONS AND BUTTONHOLES

buttons

- Flexi-Stitch Dial: 0
- Pattern Selector:  (plain zig-zag)
- Needle Position:  (left)
- General-Purpose Presser Foot
- Feed-Cover Needle Plate

Flat buttons can be sewn on quickly and easily using the plain zig-zag stitch. The space between the holes in the button determines stitch width settings. For buttons with standard hole spacing, use settings  and  as shown. For buttons with unusual hole spacing, use setting  and increase or decrease the width () as necessary.

1. Attach feed-cover needle plate (see page 7), and turn *Flexi-Stitch* dial to 0.
2. Set stitch width at  and needle position at  (left). Position button under foot and lower needle into center of left hole by turning hand wheel toward you. Lower foot. Turn hand wheel toward you until needle rises out of button and is just above the foot.
3. Set stitch width at medium-wide zig-zag () setting. Check stitch width by turning hand wheel slowly toward you; the needle should enter the right hole of the button. Take six or more zig-zag stitches to attach button. End on left side.
4. To fasten stitching, return to stitch width  and take three or four stitches.

Replace feed-cover needle plate with the general-purpose needle plate when work is completed.

NOTE: For best results, and when using buttons less than one inch in diameter, the button sewing foot is recommended (see page 58).

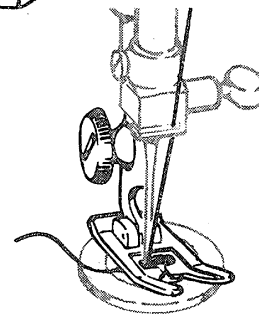
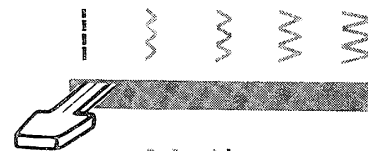
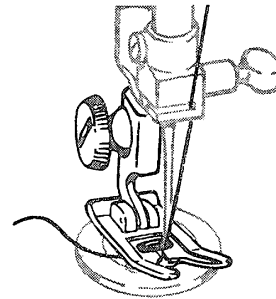
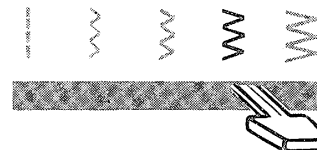
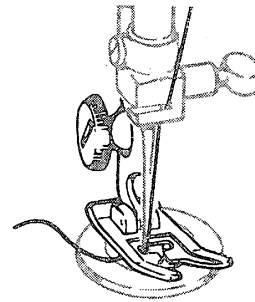
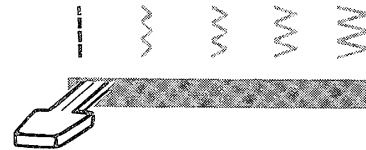

buttonholes

BUTTONHOLE POSITION

Accurate guidelines are essential to keep buttonholes a uniform distance from the faced edge of the garment, evenly spaced, and on the grain of the fabric. For center closures, place guidelines as follows:

1. Mark the center line of the garment as indicated on your pattern. This guideline can be hand basted and should follow a lengthwise fabric thread.
2. Mark a position guideline for each buttonhole.

- *Horizontal* buttonholes are placed to extend $\frac{1}{8}$ inch beyond the center-line basting of the garment. Horizontal guidelines for the buttonholes should follow a crosswise thread of the fabric and, if basted, be longer than the finished length of the buttonhole. Determine the length of the buttonhole (as described below) and mark ends of each buttonhole vertically.

- *Vertical* buttonholes are placed so that the center-line basting of the garment is in the center of the buttonholes. Determine buttonhole length and mark ends of each buttonhole horizontally across the center line and use the center-line basting as a buttonhole guide when stitching.

BUTTONHOLE LENGTH

First, decide how long the button opening must be. Then, add $\frac{1}{16}$ inch to the measurement for *each* bar tack (the closing stitches at each end of the buttonhole). To find the length of the button opening, cut a slit in a scrap of fabric the diameter of the button you intend to use. Increase length of opening until button slips through easily.

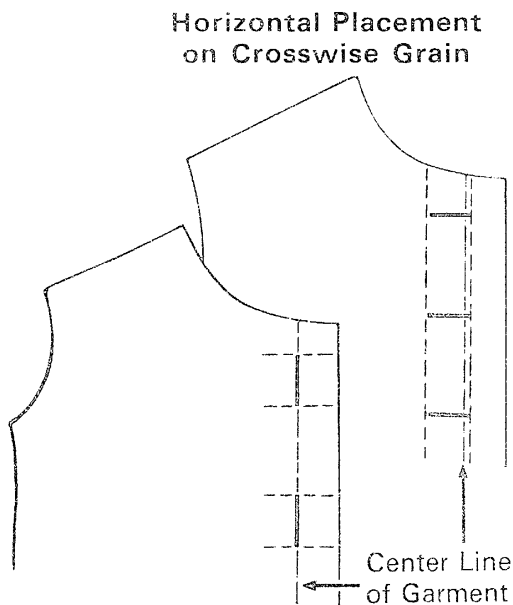

Vertical Placement on Lengthwise Grain

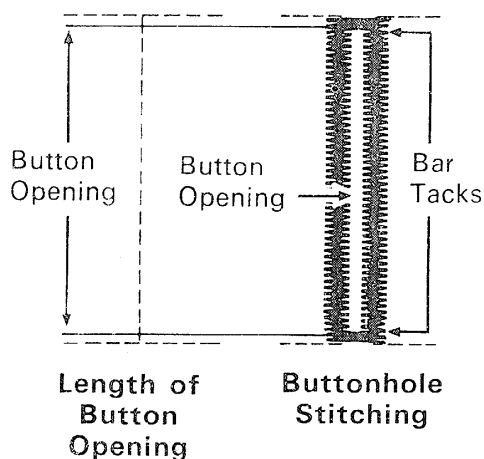
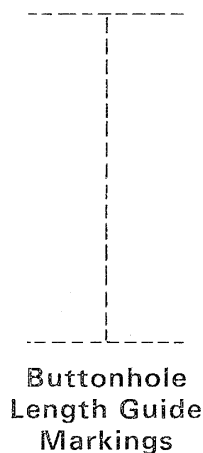

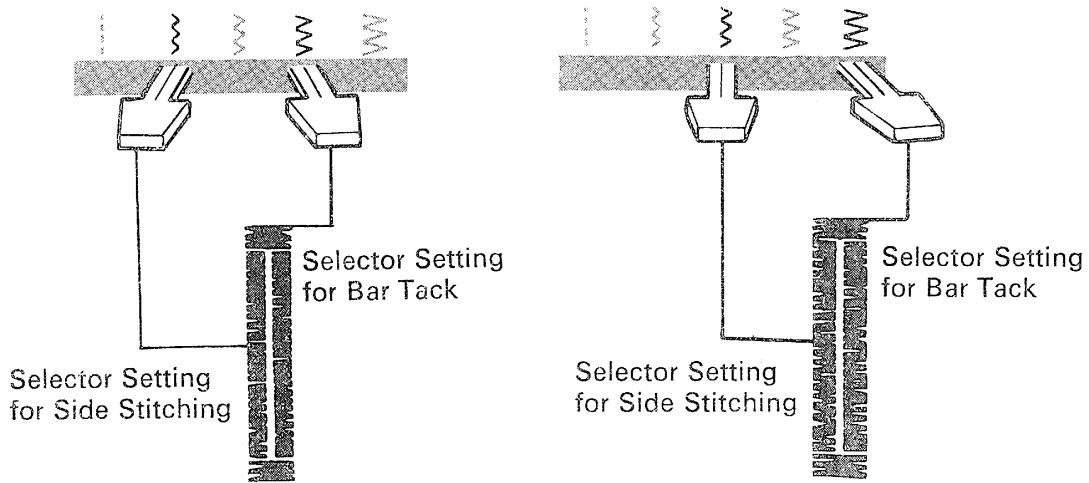

STITCH WIDTH

Two stitch width settings are required for making buttonholes: one for side stitching and one for the bar tack. Two possible combinations are illustrated.



Procedure

Set *Flexi-Stitch* dial at 0 and set stitch length in FINE area of stitch length dial. Attach special purpose foot.

Set the pattern selector at , needle position selector at , and stitch width selector at the width desired for the side stitching. Place work under needle, aligning center marking of buttonhole with center slot in the special purpose foot.

Side Stitching

Position needle in fabric at point A. Lower foot and stitch to end of marking. Leave needle in fabric at point B. Raise foot and pivot work on needle. Lower foot. Take one stitch without changing width setting, bringing work to point C.

Bar Tack

Adjust stitch width selector for bar tacks and take at least six stitches. Stop at point D.

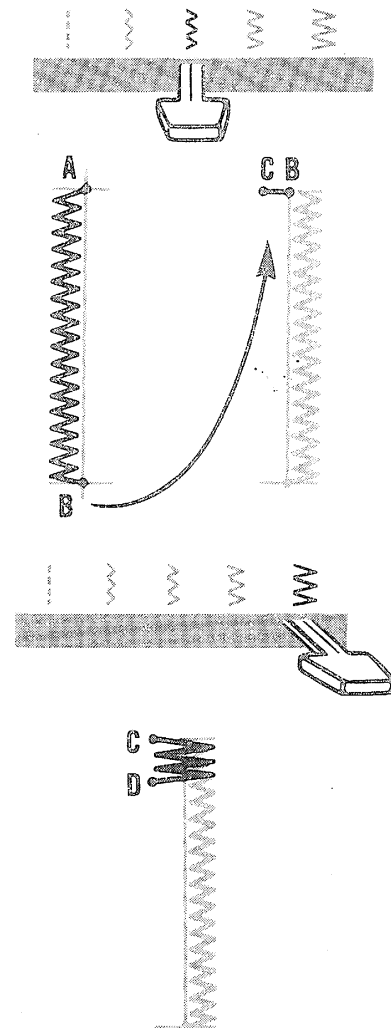

BUTTONHOLES (Continued)

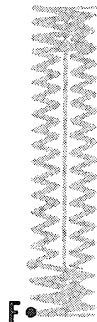
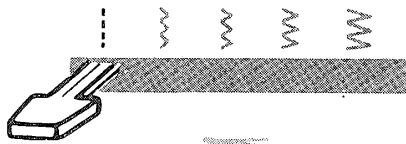
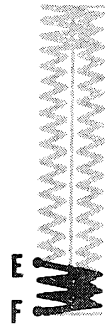
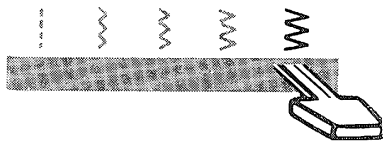
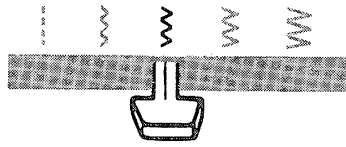

Side Stitching

Readjust stitch width selector for side stitching. Complete work to point E. Leave needle in fabric.

Final Bar Tack

Adjust stitch width selector for bar tacks, and take at least six stitches ending at point F.

Fastening Stitch

To secure stitching, move selector to  and take three stitches. Remove work, draw threads to underside, fasten, and trim. Cut opening for button with sharp scissors.





SEWING THE PROFESSIONAL WAY

sewing knit and stretch fabrics

When you sew stretch fabric, doubleknit, tricot and jersey, choose one of the stitch patterns that sew stretch into the seam. A variety of different stitches are available so you can choose just the right one for your fabric and sewing job. The table below will help you make the right selection.

Remember to use a ball-point needle (Style # 2045) in the machine and increase presser bar pressure when you attach elastic or sew a synthetic knit or stretch fabric.

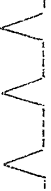

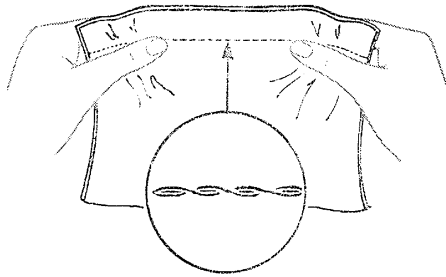

STRETCH STITCH CHART

Stitch	Where to Use
 Straight Stretch Stitch	Plain seams that s-t-r-e-t-c-h (press-open or closed construction)—Crotch seaming—Sleeve and gusset insertion—Flexible topstitching—Swim and ski suit construction—Attaching patch pockets—Repairing and reinforcing seams.
 Plain Zig-Zag Stitch	All-purpose stretch sewing—Lingerie seams—Attaching stay tapes—Seam finishing—Edge finishing—Attaching stretch lace.
 Blindstitch	Flexible blindstitch hemming—Overcast seam finishing—Shell hems in lingerie—Ladder seams—Blindstitch zipper insertion.
 Ric-Rac Stitch	Heavy-duty, all-purpose stretch sewing—Reversible topstitch applications.
 Slant Overedge Stitch	Overedged seams that stretch in sportswear, knitwear, slacks, and bathing suits.



Straight Stretch Stitching

PLAIN STRETCH SEAMS

- Flexi-Stitch Dial: Red 
- Pattern Selector: Any Setting
- Needle Position: 
- Stitch Width: 
- Stitch Length Dial: Red 
- General-Purpose Needle Plate
- General-Purpose or Special-Purpose Foot
- Speed: Moderate

When you use the straight stretch stitch to seam knit, stretch, and elasticized fabric, *s-t-r-e-t-c-h* and strength are built in as the seam is being sewn. Because it is equally useful for closed or press-open seam construction and will not break thread under stress, the straight

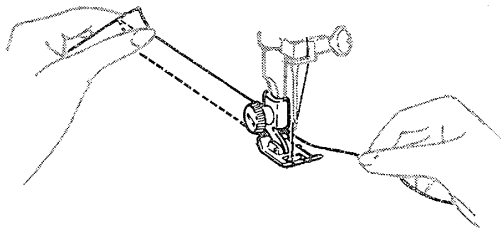

Applying Gentle Tension

stretch stitch is also good for seams that receive an unusual amount of strain when worn. For example: crotch seaming, sleeve insertion, and construction seams in sportswear and bathing suits.

Procedure

1. Make a test sample to determine thread tension and stitch balance. Be sure to insert a ball-point (yellow band) needle in machine if you are stitching a synthetic knit fabric, and increase presser-bar pressure if necessary.
2. Stitch and guide fabric as you do for plain seams stitched with the regular straight stitch, letting the machine make the back-and-forth stitches that give *s-t-r-e-t-c-h* to the seam. If fabric has an unusual amount of elasticity, it should be stitched under tension as instructed under "Guiding and Supporting Fabric" (see below).
3. Press seam as when using the regular straight stitch.

GUIDING AND SUPPORTING FABRIC





Most fabrics of stretch or knit construction need only to be guided in front of the presser foot when you use one of the stretch stitches. Simply increase presser bar pressure and let the machine move the fabric to make the stitches that give *s-t-r-e-t-c-h* to the seam.

Some fabrics, however, require support while being stitched.

- For nylon tricot, ciré, panné velvet and similar synthetic knits, apply *gentle* tension by holding fabric taut in front *and* back of the presser foot as you sew.

ATTACHING ELASTIC

Elastic will remain stretchable when it is attached with the plain zig-zag stitch. The flexible joining produced by this stitch allows elastic banding to be stitched under, over, or between fabric layers, making it particularly useful in the construction of lingerie and swimsuits.



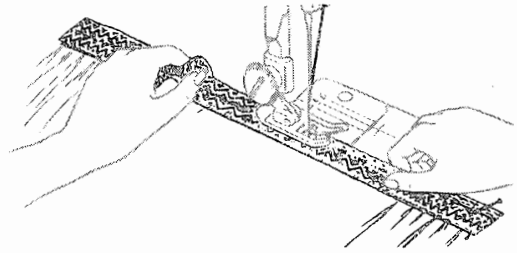

- Flexi-Stitch Dial:  (Off)
- Pattern Selector:  (plain zig-zag)
- Needle Position: 
- Stitch Width:  (maximum)
- Stitch Length: About 20
- General-Purpose Needle Plate and Foot



Attaching Elastic with Plain Zig-Zag

OVEREDGED SEAMS

Seams in knit and stretch fabrics can be joined and finished in one operation with the slant overedge stretch stitch.

- Flexi-Stitch Dial: Red 
- Pattern Selector:  (slant overedge)
- Needle Position: 
- Stitch Width:  (maximum)
- Stitch Length Dial: Red 
- General-Purpose Needle Plate and Foot
- Speed: Moderate

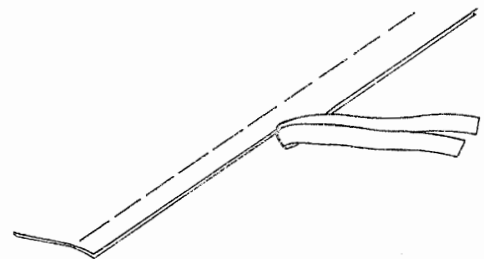

Trimming Seam Edges

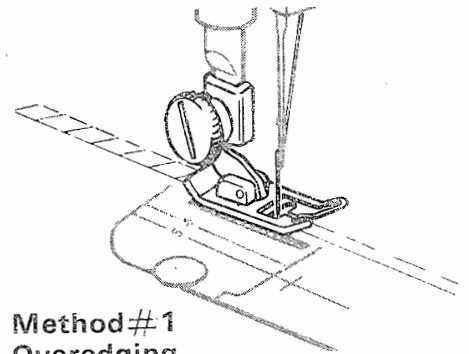

Method #1
Overedging

Two different methods may be used. Method #1 (overedging) is recommended for firm fabrics in garments where a $\frac{1}{4}$ -inch seam allowance is adequate. Method #2 (mock overedging) is most appropriate for bulky knits and fabrics that have a tendency to curl or fray and should be used where a wider seam allowance is needed. Make a test sample to help you decide which method is best for your fabric and garment. Be sure to duplicate the cut of the garment seam in your test.

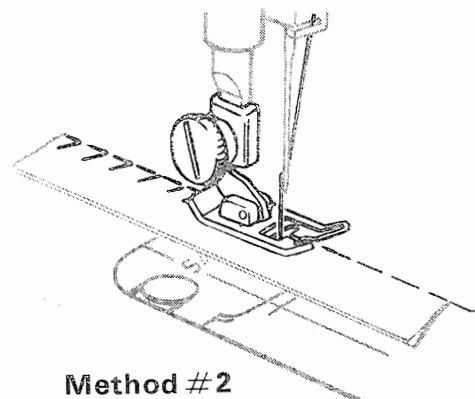

Method #2
Mock Overedging

Remember to use a ball-point (yellow band), Style 2045, Size 14 needle in your machine if you are sewing a synthetic knit.

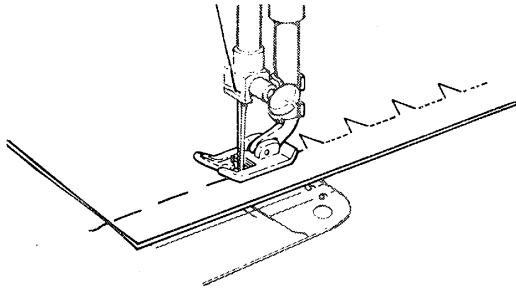

Blindstitching Ladder Seam

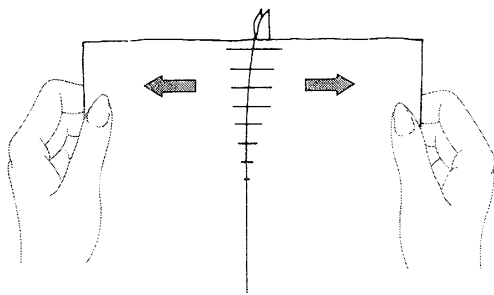

Opening Seam to form Ladder Effect

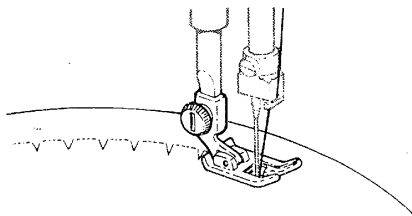



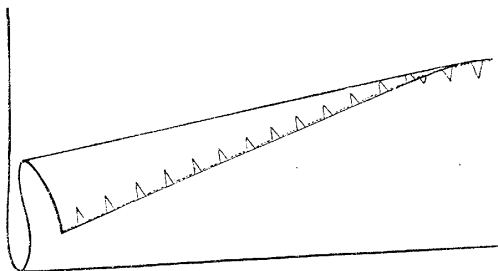

Applying Facing Finish



Finished Hem Edge

LADDER SEAMS





A ladder seam made with blindstitching is both functional and decorative. Particularly appropriate for knit and stretch fabrics, the blindstitch provides stretchable, decorative construction seams, and edge finishes for necklines, pockets and collars in sportswear and swimwear.

- Flexi-Stitch Dial:  (Off)
- Pattern Selector:  (blindstitch)
- Needle Position:  (center)
- Stitch Width:  (maximum)
- Stitch Length: **10 to 15**
- Thread Tension: Lighter than normal
- General-Purpose Needle Plate and Foot

After stitching, open seam by pulling fabric back on opposite sides of seam to produce ladder effect. Press seam allowances of construction seams to one side. Seam allowances of enclosed seams are pressed together in the usual way after seam has been opened.

FINISHES FOR HEMS AND FACINGS

Hems and facing edges in knit and stretch fabrics will be less apt to press through and mark when given a flat edge finish. Edge finishing with the plain zig-zag stitch or blindstitch eliminates the bulk of turned-in edges and retains fabric flexibility.

- Flexi-Stitch Dial:  (Off)
- Pattern Selector:  (plain zig-zag)
or  (blindstitch)
- Needle Position:  (center)
- Stitch Width:  (maximum)
- Stitch Length: **8-20** (depending on fabric)
- General-Purpose Needle Plate and Foot

1. Make a test sample.
2. Place stitching close to hem or facing edge.
3. Press after stitching and trim away excess fabric close to the stitching line, if necessary.

LINGERIE SEAMS

To make seams in lingerie durable and flexible, use a combination of straight and zig-zag stitching.

Method # 1

For $\frac{5}{8}$ -inch bias seam in woven fabric:







- Straight-stitch the seam (with stitch width at $\frac{1}{2}$) on wrong side of fabric.
- Press both seam allowances in the same direction. Then, from the right side, top-stitch with narrow zig-zag stitching, letting needle alternately enter seam line and seam thickness.

Method # 2

For narrow seams in nylon tricot:

- Cut fabric for $\frac{5}{8}$ -inch seam allowance.
- Straight-stitch seam line on wrong side of fabric. Then place a line of medium-wide, open zig-zag stitching close to the straight stitching.

SEAM FINISHES

- Flexi-Stitch Dial:  (Off)
- Pattern Selector:  (plain zig-zag) or  (blindstitch)
- Needle Position: 
- Stitch Width:  or  (maximum)
- Stitch Length: 8-20, depending on choice of stitch and fabric
- General-Purpose Needle Plate and Foot

Seam edges support the garment and should be given a durable finish if the fabric is likely to ravel. There are two methods of finishing seams in such fabrics: trimming seam edge or overedging. Make a test sample first to determine which method best suits your fabric.



For a 5/8-inch Seam

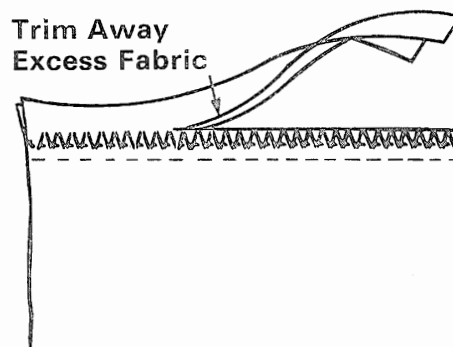

For a Narrow Seam

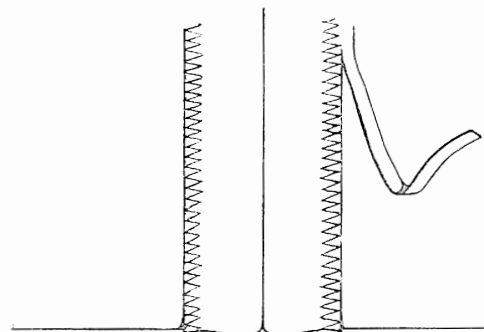

Trimming Seam Edges after Stitching

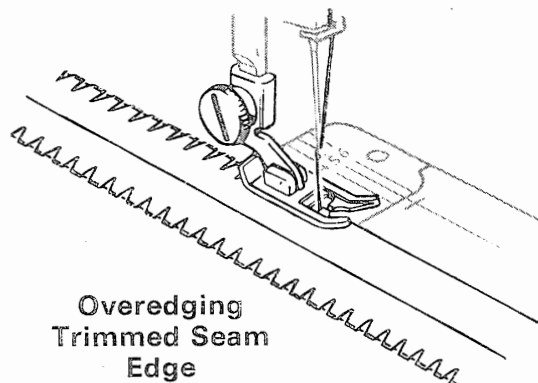

Overedging
Trimmed Seam
Edge

hints on sewing special fabrics

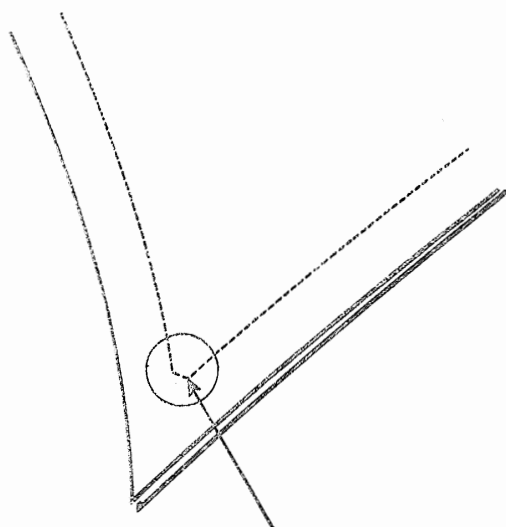

**Diagonal Stitching
Across the Point**

LEATHER-LOOK VINYL*

- Use masking tape or zipper adhesive tape instead of pins or basting to hold seams, zippers and hems in place for stitching.
- Stitch with a long stitch (8 to 10 straight stitches per inch). A short stitch may cut the fabric.
- Sew with a steady, even pace and stitch accurately. Seams cannot be ripped out without leaving needle marks in the fabric.
- The shiny side of some vinyls tends to stick to metal surfaces. Use a strip of tissue paper between the fabric and metal machine surfaces to prevent this.
- Topstitching holds seams and garment edges smooth and flat and adds a decorative note.
- Reinforce button and buttonhole areas with interfacing. Bound buttonholes are the best choice for vinyls with knit backing.
- For sharp points on collars and lapels, take one or two stitches diagonally *across* the point to allow enough space to smoothly enclose the seam edge.

CIRÉ (Wet-Look Taffeta and Tricot)*

- Use masking tape or zipper adhesive tape instead of pins or basting to hold seams, zippers, and hems in place for stitching.
- Stitch accurately; seams cannot be ripped out because needle marks remain in the fabric.
- Sew seams under light tension by holding fabric slightly taut at front and back of needle.
- Stitch ciré taffeta with a fairly long stitch (8–10 straight stitches per inch) and use an enclosed edge finish for seams and hems.
- Stitch ciré knits with a medium-length stitch (12 straight stitches per inch) and use a fine ball-point needle.
- Machine-worked buttonholes (as well as bound buttonholes) can be made in ciré fabric. Always use an interfacing and make sure the close zig-zag stitches do not cut the fabric.

*The Even Feed foot described on page 58 is designed to aid in sewing this fabric.

DEEP-PILE FABRICS (Fake Fur)*

- Pin, rather than baste, seams. Place pins at close intervals at right angles to the seam line. Pins with colored heads are easy to see and remove.
- Sew in direction of nap.
- Stitch with a fairly long machine stitch (8 to 10 straight stitches per inch) and use polyester/cotton thread in a size 14 or 16 Style # 2020 needle.
- As seam is stitched, smooth pile *away* from seam allowance with a darning needle or upholstery pin.
- After stitching seams with a $\frac{5}{8}$ -inch seam allowance, use small hand scissors to shear pile from entire seam allowance to reduce bulk.
- Stitch $\frac{1}{4}$ -inch pre-shrunk tape into neckline and shoulder seams for stability and reinforcement or stitch with the straight stretch stitch.
- Leather and leather-look fabrics complement fur fabrics; use them for bound buttonholes and easy button loops.
- Coat hems are less bulky if they are narrow and finished with a 3-inch fabric facing or grosgrain ribbon.
- Slash through the center fold of darts and finger-press open, or stitch with a narrow zig-zag stitch and trim away excess fabric after stitching.

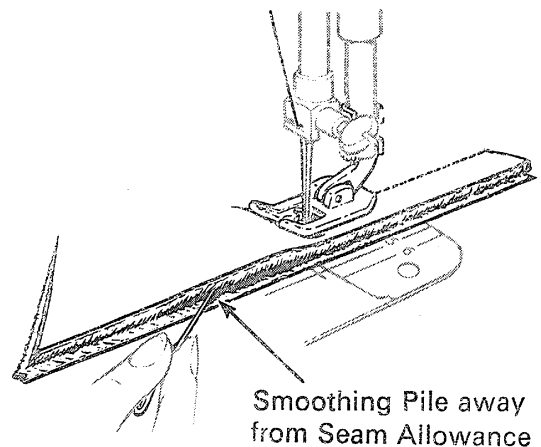

Deep-Pile Fabrics

VELVET AND VELVETEEN*

- Use a light-pressure dial setting to prevent crushing pile.
- Mark and baste with silk thread.
- Use a Style # 2020, size 11 needle, and a fine thread for seaming. "A" silk or nylon thread is recommended for velvet.
- Always stitch in the direction of the nap.
- For unpuckered seams, pin or hand baste together and then stitch under light tension (see page 18). Extra-long, straight seams may be machine basted with a long, wide zig-zag stitch.
- When inserting a zipper, use the blindstitch for an almost invisible finish (see page 43).
- To sew panné velvet, use a ball-point needle and a shorter-than-normal stitch length (12 to 15 straight stitches per inch).

*The Even Feed foot described on page 58 is designed to aid in sewing this fabric.

construction details

ZIPPERS

At the notions counter in your Singer Sewing Center, you will find many different kinds of zippers, one of which will be just right for whatever you want to sew. The zipper package will contain easy-to-follow instructions for inserting the zipper. And, with the zipper foot, you will find it easy to form an even line of stitching close to the zipper.

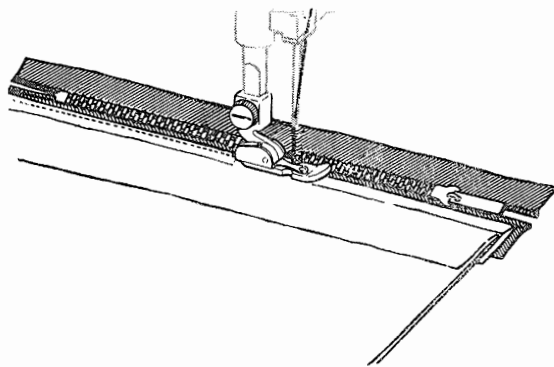

Zipper Insertion

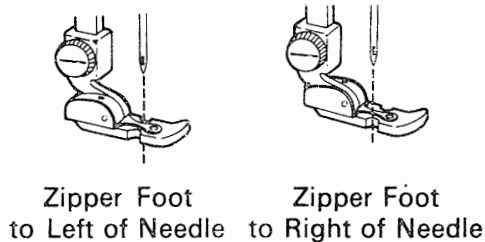
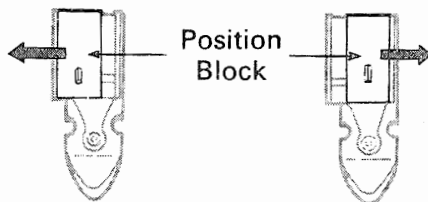

- Flexi-Stitch Dial: (Off)
- Pattern Selector: Any setting
- Needle Position:
- Stitch Width:
- General-Purpose Needle Plate
- Zipper Foot

Attaching the Zipper Foot

When the zipper is to the *right* of the needle:

- Move position block on zipper foot to left, to allow shank to enter right side of foot, so that needle will enter right notch in foot.

When the zipper is to the *left* of the needle:

- Move position block on zipper foot to right, to allow shank to enter left side of foot, so that needle will enter left notch in foot.

(The zipper foot is snapped onto shank as instructed on page 7.)

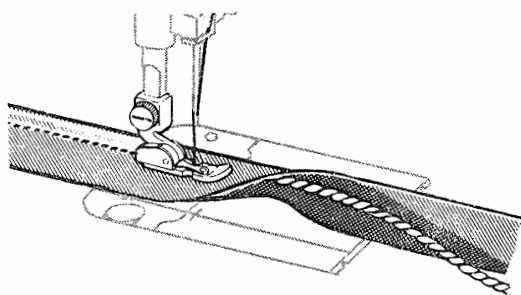

CORDED SEAMS

The corded seam is a professional treatment for slipcovers, children's clothes, blouses, and lingerie. To make a corded seam, make the welting first (or buy it ready-made at a notions counter), then stitch it into the seam. For both steps, use the zipper foot to place the stitching close to the cord.



Making Welting for a Corded Seam

BLINDSTITCH ZIPPER INSERTION

- *Flexi-Stitch* Dial: **O** (Off)
- Pattern Selector:  (blindstitch)
- Needle Position: 
- Stitch Width:  (narrow)
- Stitch Length: **12**
- General-Purpose Needle Plate
- Zipper Foot

Blindstitching, used instead of straight stitching for the final step in zipper insertion, gives a fine finish that is almost invisible. Indispensable for knits, napped fabrics, and sheers.

1. Allow for a $\frac{7}{8}$ -inch seam allowance in the zipper area when you cut garment.
2. Insert zipper in the usual way up to the final step; then, turn garment right side out and spread flat with zipper face up.
3. Work from the right side and pin zipper tape into position.
4. Baste a guideline for blindstitching alongside zipper, about $\frac{3}{8}$ -inch from garment seam. Make sure basting stitches go through all fabric layers and zipper tape. Remove pins.
5. Adjust zipper foot to right side of needle.
6. Turn garment wrong side out. Place lower end of zipper tape over feed and turn front section of garment back to line of basting, creating a soft fold to the left of the needle.
7. Set stitch width selector and position work so that the straight stitches will go through the seam allowance and zipper tape, and the sideward stitches catch a few threads of the fold.
8. Lower zipper foot and stitch slowly. After stitching, remove basting and press lightly.

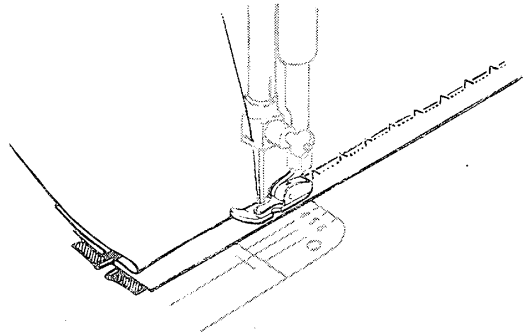

**Final Step of Blindstitch
Zipper Insertion**

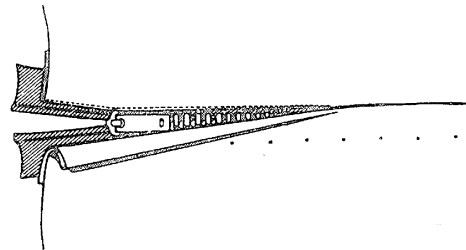

**Completed Blindstitch
Zipper Insertion**

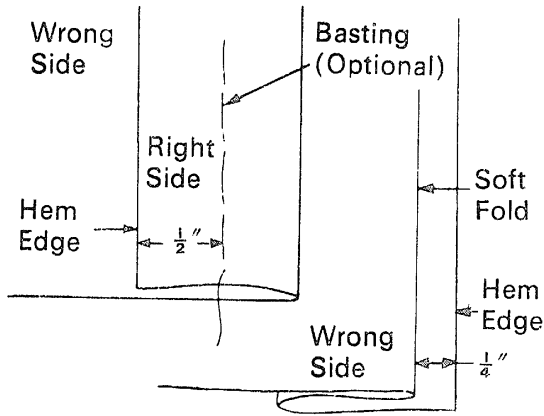

Creating Soft Fold

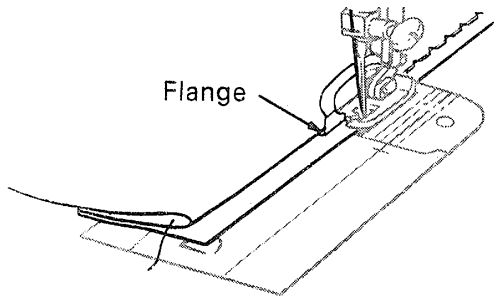

Blindstitching Hem

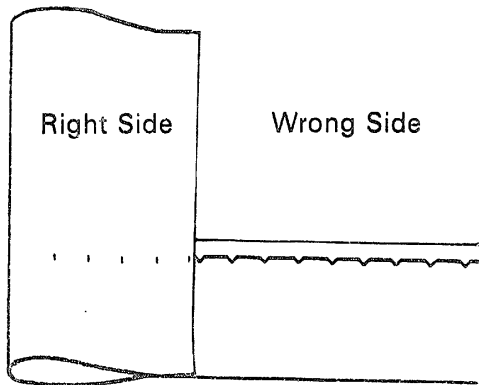

Blindstitch Hem Completed

BLINDSTITCH HEMS

- Flexi-Stitch Dial: (Off)
- Pattern Selector: (blindstitch)
- Needle Position: or
- Stitch Width: to
- Stitch Length: 10-20
- General-Purpose Needle Plate and Foot
- Blindstitch Hem Guide

Blindstitching provides a durable hem finish that can be used on a variety of light and medium weight fabrics. It is best suited to straight hems. Taped, bound, turned, or unfinished hem edges can be blindstitched with equal ease. Blindstitching takes a little practice, however, so make a test sample first.

1. Attach blindstitch hem guide as instructed on page 6.
2. Mark, turn, and press hem in the usual way. (You may want to baste the turned hem to hold it in place. If so, be sure to place the basting at least $\frac{1}{2}$ inch from hem edge.)
3. With the work wrong side up, turn the hem under, creating a soft fold about $\frac{1}{4}$ inch from hem edge. Press lightly.
4. Position the hem under the foot with the soft fold resting against wall of guide. Make sure flange of guide is between the soft fold and top of hem.
5. Lower the presser foot and stitch so that the straight stitches fall on the hem edge and the sideward stitches pierce the soft fold. While stitching, guide hem edge in a straight line and feed the soft fold evenly against the wall of the hem guide.

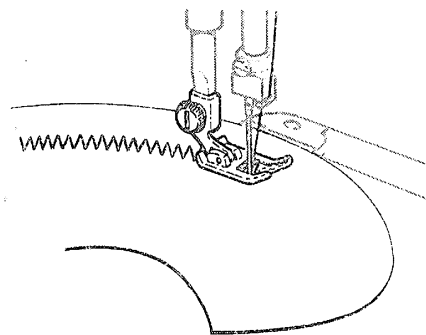

TOPSTITCHING

A practical, simple way to accent the lines of a dress or coat is to place one or more rows of stitching along collars, lapels, facing edges, pockets, seams, etc. For a tailored look, use lines of regular straight stitching; sew them with button-hole twist for added emphasis. For decorative interest, use a zig-zag or *Flexi-Stitch* pattern. To add firmness to hems and seams in knit and stretch garments, topstitch with the straight stretch stitch. The seam guide (see page 58) will help you place stitching accurately.



Topstitching
with Plain Zig-Zag Stitch

DARTS IN INTERFACING

- *Flexi-Stitch* Dial: ○ (Off)
- Pattern Selector:  (plain zig-zag)
- Needle Position: 
- Stitch Width:  (maximum)
- Stitch Length: 25 or to suit fabric
- General-Purpose Needle Plate and Foot

With zig-zag stitching, interfacings can be shaped without bulk.

1. Cut out the dart allowance on the stitching line.
2. Bring raw edges together and pin or baste in place over a muslin stay.
3. Stitch, backstitching at both ends of dart for reinforcement.

Steps in Making a Dart in Interfacing

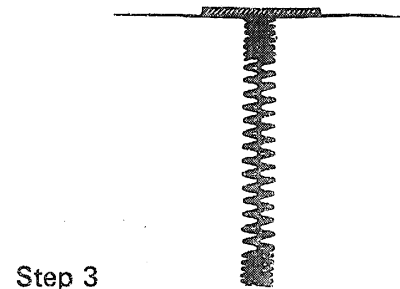
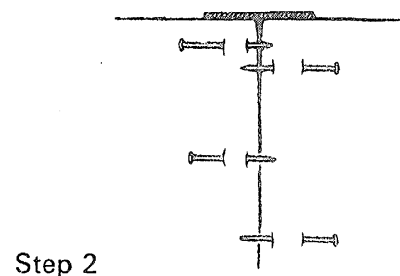
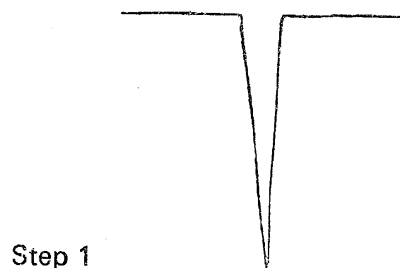

decorative touches

APPLIQUÉ

Appliqué adds beauty and interest to clothing and household linens. You can create your own design, trace a simple outline from a coloring book, or use a motif cut from a printed fabric. Fabrics of like or different texture combine equally well.

A closely spaced zig-zag stitch is most commonly used in appliqué work, but other stitch patterns may also be used effectively. Although you may vary stitch width to accommodate fabric weave or texture, never allow the stitch to be too wide.

When appliquéing, make a test sample to help you decide which of the following methods is more appropriate for your fabric and design.

Preparation

- Baste appliqué design to fabric.
- Outline design with straight stitching (use a short stitch).
- Remove basting and press.
- Attach special purpose foot.

Method # 1—Trimming after Stitching

1. Set machine for desired appliqué stitch and set stitch width. Adjust stitch length in the FINE area of the stitch length dial.
2. Outline the entire design with appliqué stitching.
3. Cut away the fabric on the outer edges of the stitching with embroidery scissors.

Method # 2—Stitching After Trimming

1. Trim outside fabric edges close to straight stitch outline of design.
2. Set machine for plain zig-zag stitching and set stitch width. Adjust stitch length in the FINE area of the stitch length dial.
3. Overedge the design with zig-zag satin stitching. This step will produce a smooth, lustrous finish that requires no additional trimming.

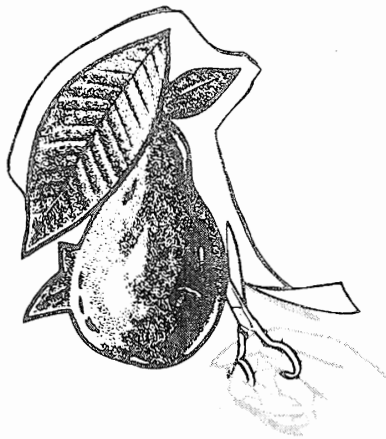





Method 1
Trimming after Stitching



Method 2
Stitching after Trimming

SHELL EDGING

- *Flexi-Stitch* Dial : **0** (Off)
- Pattern Selector :  (blindstitch)
- Needle Position : 
- Stitch Width :  to 
- Stitch Length : **12** to **25**
- General-Purpose Needle Plate and Foot

On soft, fine fabrics such as tricot, voile and crepe, shell edging makes an attractive finish for narrow hems or bias folds in blouses, slips and petticoats.

Make a test on a sample of your fabric to find the right thread tension, stitch length, and stitch width.

1. Place folded hem (basted, if necessary) or bias fold under presser foot, with hem or fold to the left.
2. Stitch slowly, guiding fabric so that the sideward stitches are made over the folded edge.

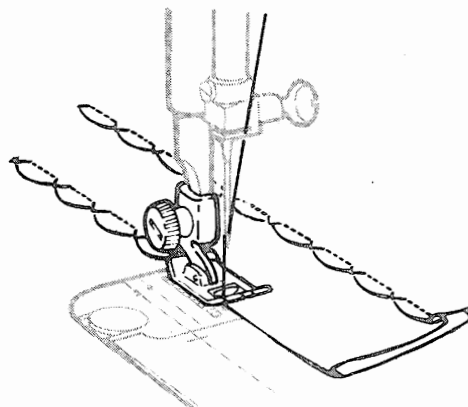





**Shell Edging with
the Blindstitch**

keeping up appearances

MENDING

The plain zig-zag pattern is just as useful for mending as it is for creative sewing. It forms a flexible bond for repairing tears and stretch garments.

Mending a Tear

- Flexi-Stitch Dial:  (Off)
- Pattern Selector:  (plain zig-zag)
- Needle Position: 
- Stitch Width:  or  (maximum)
- Stitch Length: About 25
- General-Purpose Needle Plate and Foot

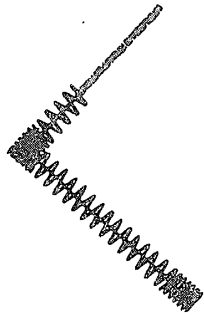

Tear Mended with
Plain Zig-zag

1. Trim ragged edges.
2. Place underlay on the wrong side of tear for reinforcement. (It is best not to baste or pin the underlay since you will be bringing the edges of tear together in the next step.)
3. Stitch on the right side, bringing the edges of the tear together.
4. Shorten stitch length at ends and corners to give extra strength.
5. Trim underlay.

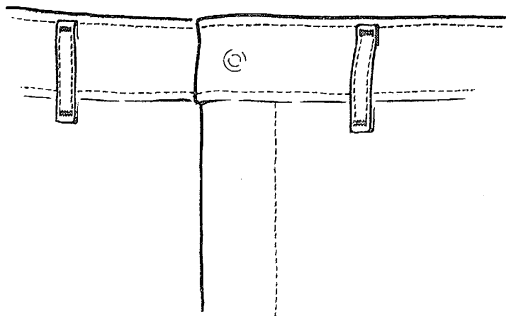





Bar-Tacked Belt Loops

Bar Tacks

Bar tacks, to reinforce points of strain, are made with the plain zig-zag stitch at satin stitch length. Use them at pocket corners, to attach garters, secure shoulder straps, belt loops and zipper openings.

Repairing Stretch Garments

- *Flexi-Stitch* Dial:  (Off)
- Pattern Selector:  (plain zig-zag)
- Needle Position: 
- Stitch Width:  to 
- Stitch Length: **25** or to suit fabric
- General-Purpose Needle Plate and Foot

Seams and hems in stretch and elasticized garments retain their elasticity when stitched with the plain zig-zag stitch. This stitch is particularly effective when used in topstitch applications (as shown) or to overedge. Make a test sample to check selector settings.

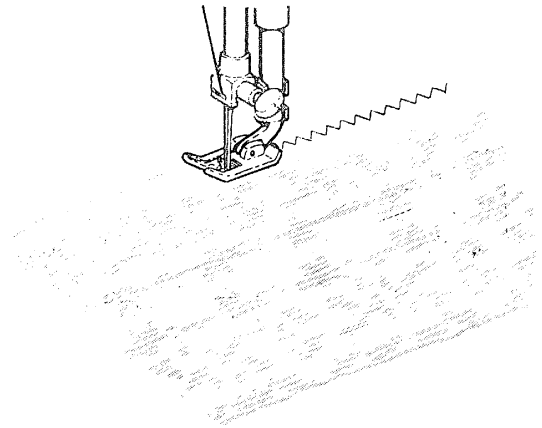

Stretch Garment Repair

Repairing Seams

Breaks in press-open seams can be repaired quickly and easily when you use the straight stretch stitch. This stitch is ideal for knit and stretch fabrics, and particularly useful for repairing or strengthening curved seams, or seams that will receive strain when worn.

1. Make a test sample to check selector settings.
2. Remove loose thread along the break and press seam edges *together*.
3. Re-stitch along original seamline, guiding seam under presser foot without stretching fabric, letting the machine move the fabric to make the back-and-forth stitches that give *s-t-r-e-t-c-h* to the seam. Overlap stitching one inch at each end. Press seam open.

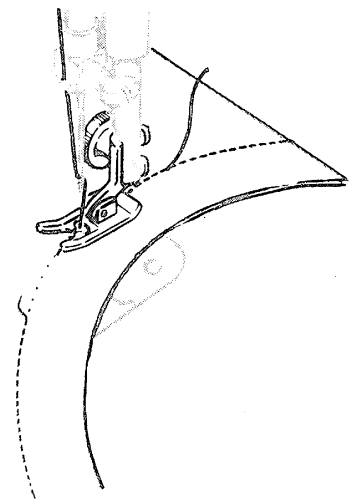

Seam Repair

DARNING

Worn or torn spots on children's clothes, knits, and household linens can be darned effortlessly and quickly with little practice. You may choose to darn either with or without an embroidery hoop. When greater control is needed, an embroidery hoop is usually best.

Darning without Embroidery Hoop

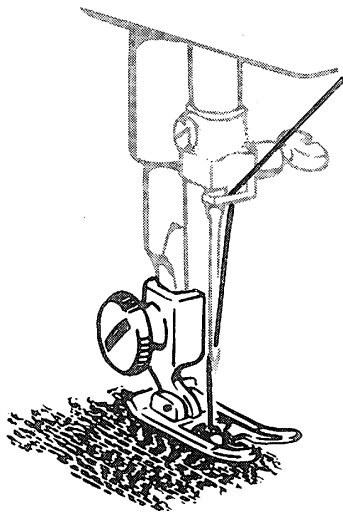



Darning Without Embroidery Hoop

- Flexi-Stitch Dial: **O** (Off)
- Pattern Selector: Any setting
- Needle Position: 
- Stitch Width: **⋮**
- Stitch Length: **12**
- General-Purpose Needle Plate and Foot
- Pressure: **D**

1. If area to be darned is open, baste an underlay in place.
2. Place area to be darned under presser foot; lower presser foot and start stitching, alternately drawing fabric toward you and pulling it *gently* away from you.
3. Continue this forward and backward motion as you fill the area with parallel lines of stitching. For additional strength, cover area with crosswise lines of stitching.

Darning with Embroidery Hoop

- *Flexi-Stitch* Dial: ○ (Off)
- Pattern Selector: Any setting
- Needle Position: 
- Stitch Width: 
- Stitch Length: In Fine Area
- Feed-Cover Needle Plate
- No Presser Foot
- Presser Bar: Lowered

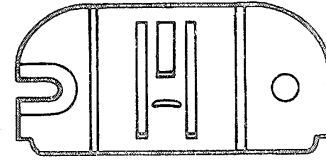

Feed-Cover Needle Plate

Preparation

Remove presser foot with shank (by removing the screw which fastens the shank to the presser bar). Attach feed-cover needle plate. Instructions for changing the needle plate are given on page 7.

1. Trim ragged edges from area to be darned.
2. Center worn section in embroidery hoop.
3. Position work under needle over feed-cover plate and *lower presser bar to engage tension*.
4. Hold needle thread loosely with left hand, turn hand wheel over and draw bobbin thread up through fabric. Hold both thread ends and lower needle into fabric.
5. Outline area to be darned with running stitches for reinforcement.
6. Stitch across opening, moving hoop under needle at a slight angle from lower left to upper right. Keep lines of stitching closely spaced and even in length.
7. When opening is filled, cover area with crosswise lines of stitching.

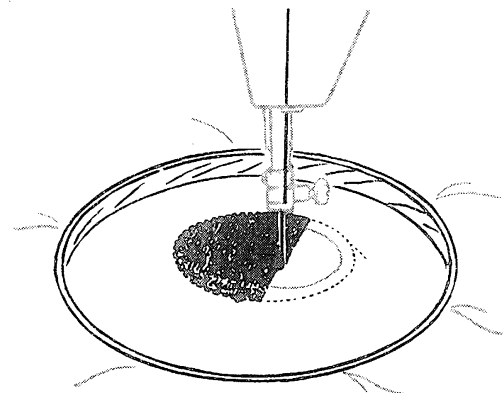
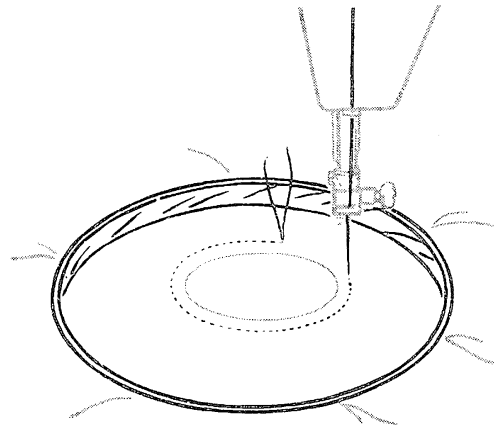

Darning With Embroidery Hoop

This method of controlling fabric movement with an embroidery hoop may be used to do embroidering and monogramming.

cleaning the machine

Your machine will serve you perfectly for many years if you take a few moments of your time to keep it clean. How often you will need to clean the machine will depend on how often you use it.

CAUTION: Before cleaning your machine, disconnect power-line plug from electrical supply.

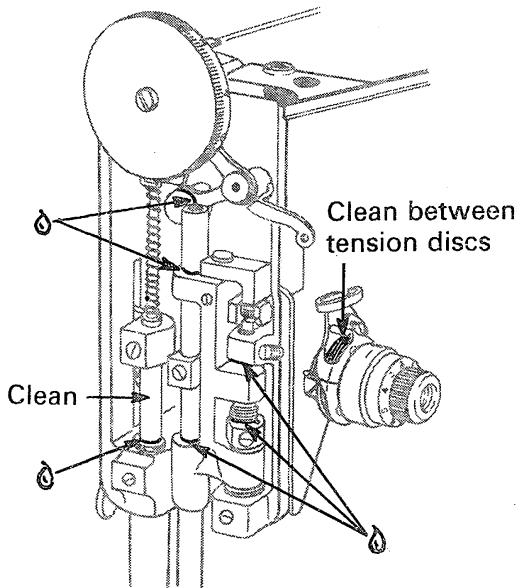

Remove lint or fluff from exposed parts. With a soft cloth, clean :

- Tension discs, take-up lever, and thread guides.
- Presser bar and needle bar.
- Bobbin case. (If there is an excessive amount of lint in the area, remove the bobbin case for cleaning. See page 54 for instructions.)
- Machine surface. (If necessary, dampen the cloth and use a mild soap.)

Remove face plate as instructed on page 53, and clean area behind it with a lint brush†.

Remove needle plate as instructed on page 7 and, using a brush, clean the rotating hook area under the needle plate and slide plate.

After cleaning, apply SINGER* oil at points indicated on these pages.

Approximately once every year under normal conditions, clean and lubricate all moving or rotating machine connections to ensure freedom of movement and to protect metal parts from excessive wear. To remove top and bottom covers, follow instructions on page 53.

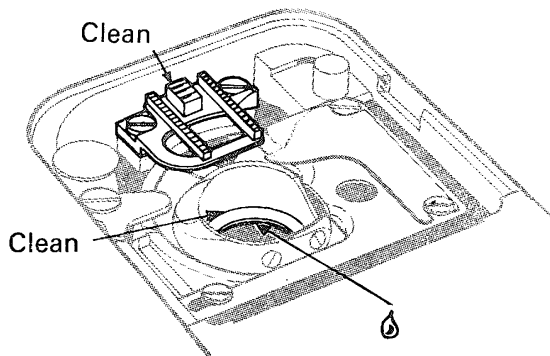

†A lint brush designed for this purpose is available for separate purchase at your local Singer Sewing Center.

removing covers, bobbin case and bulb

CAUTION: Before removing covers, bobbin case, and light bulb, disconnect power-line plug from electrical supply.

REMOVING AND REPLACING TOP COVER

- To remove, loosen and remove screws A and lift off top cover.
- To replace, position cover on top of machine and replace and tighten screws A.

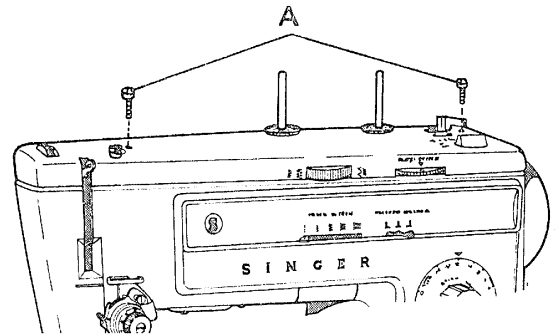

REMOVING AND REPLACING BOTTOM COVER

If your machine is a portable, remove the carrying case base as instructed below.

- To remove, tilt machine back and remove retaining nut B, being careful not to lose felt washer, and remove cover from underside of machine.
- To replace, position cover over bottom of machine and replace felt washer and retaining nut. Tighten retaining nut with a screwdriver.

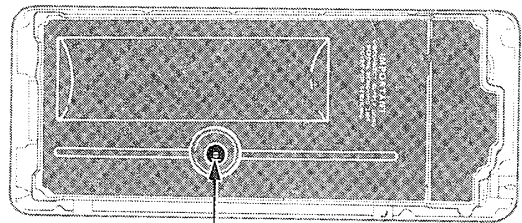

REMOVING AND REPLACING CARRYING CASE BASE

- Turn machine so that back is toward you. Tilt machine back and loosen and remove the retaining nut B from the center.
- Set machine upright and lift up and out of base.
- Replace machine in base, after bottom cover has been attached.
- Turn machine so that back is toward you; tilt back and replace retaining nut. Tighten retaining nut with a screwdriver.

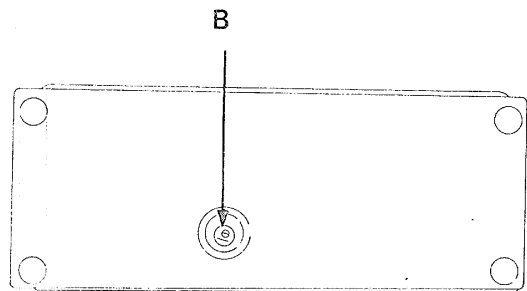

REMOVING AND REPLACING FACE PLATE

- Loosen and remove screw D and remove face plate by sliding it downward.
- Replace face plate by sliding top edge of plate under edge of arm top cover.
- Align screw hole in plate with screw hole in machine and replace and tighten thumb screw D.

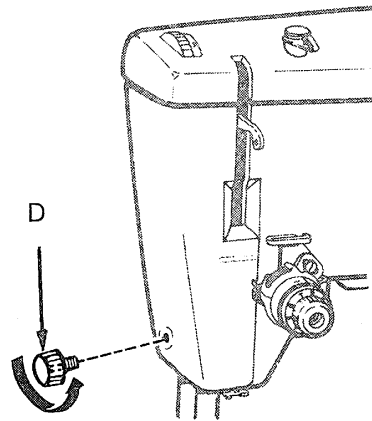

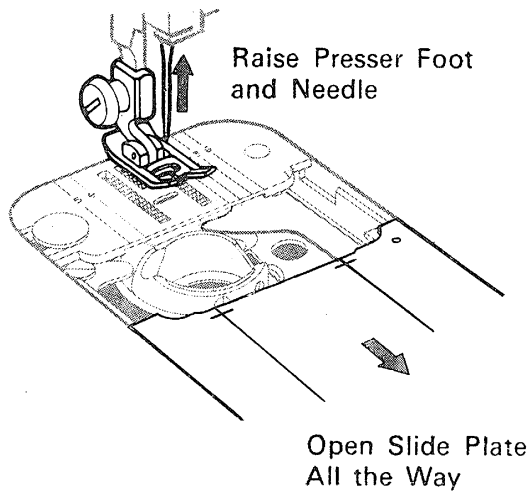

REMOVING AND REPLACING BOBBIN CASE

- Raise presser foot.
- Turn hand wheel toward you until needle is in its highest position.
- Open slide plate with downward finger pressure. Draw plate toward you, opening it *all the way* to raise the needle plate locking pin.
- Remove needle plate.
- Remove bobbin.

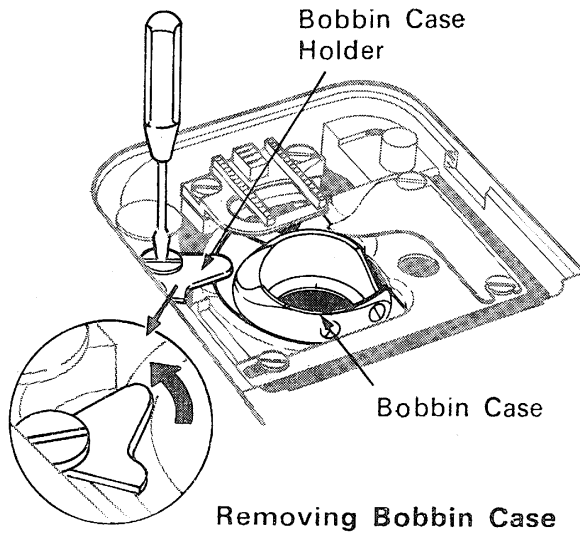

To remove bobbin case:

Turn bobbin case holder to back as far as it will go. Lift out bobbin case.

To replace bobbin case:

Guide the forked end under the feed and then draw the bobbin case under the position plate as illustrated. Turn bobbin case holder all the way forward to lock bobbin case in position. After locking the bobbin case in position, check that the bobbin case does not bind but has slight rotational movement.

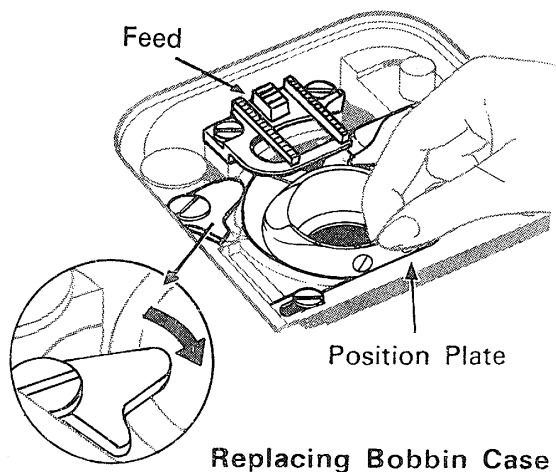

- Replace bobbin in bobbin case.
- Replace needle plate.
- Close slide plate to lower needle plate locking pin and secure needle plate.

This machine is designed to use a 15 watt maximum light bulb.

CHANGING THE LIGHT BULB

Disconnect power-line plug from electrical supply.

Removing the Bulb

With thumb and forefinger lower the light bracket. Do not attempt to unscrew bulb. Press it up into socket and at same time turn bulb over in direction shown to unlock bulb pin.

Replacing the Bulb

Press new bulb into socket, with bulb pin entering slot of socket, and turn it over in direction shown to lock bulb in position. Release bracket, and entire assembly will snap back into recess.

REPLACING THE SLIDE PLATE

You will not have any occasion to remove the slide plate. However, if it should accidentally become disengaged from the machine, it is easily replaced.

- Raise presser foot and needle.
- Place slide plate in slideway with the front edge close to, but not covering, the retaining spring (as shown in illustration).
- With a screwdriver, lift each end of the spring into each of the side grooves on the underside of the slide plate.
- Draw the plate gently toward you and fully engage the spring.
- Close slide plate.

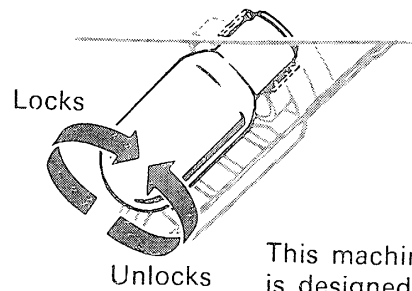

This machine is designed to use a 15 watt maximum light bulb

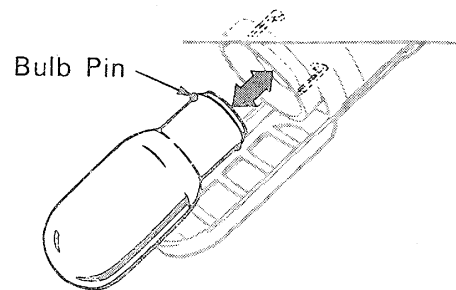

Changing the Light Bulb

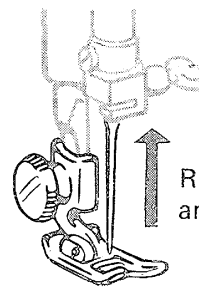

Raise Presser Foot and Needle

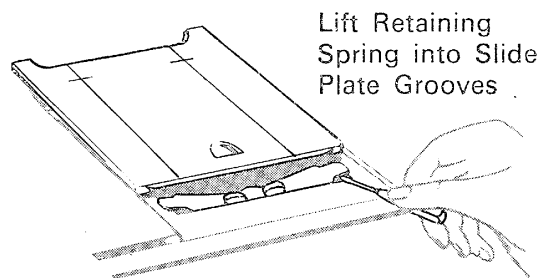

Lift Retaining Spring into Slide Plate Grooves

Replacing the Slide Plate

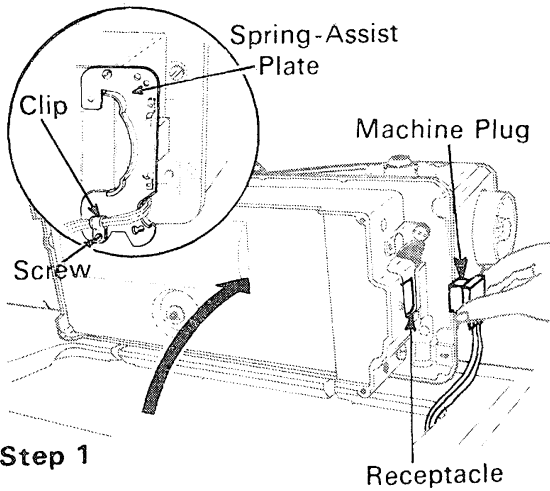

Step 1

Step 2

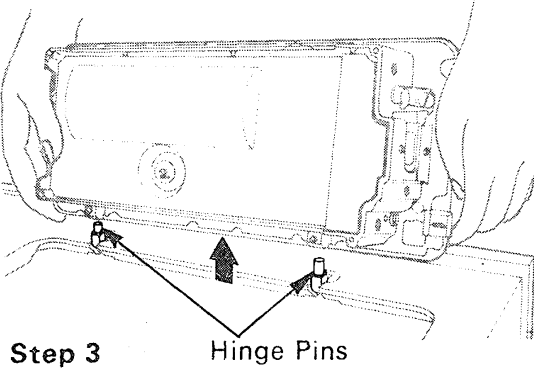
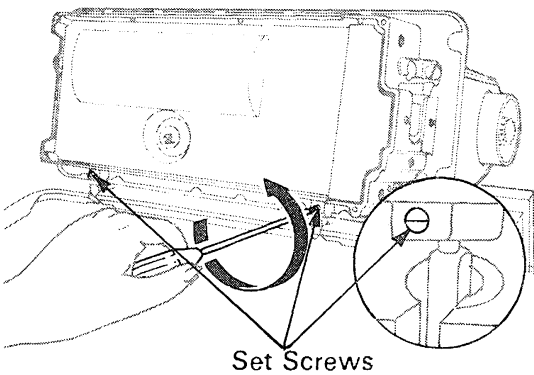

Step 3

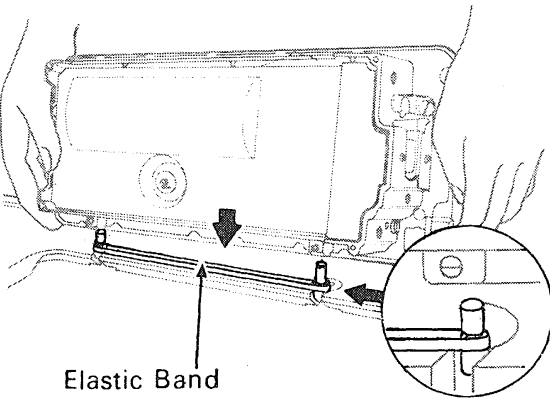

Elastic Band

REMOVING MACHINE FROM CABINET

IMPORTANT:

- Do not attempt to remove hinges from cabinet as this may result in damage to the wood of the cabinet.
- Pull cabinet away from wall to avoid damage to wall or machine.
- *Remove machine power-line plug from electrical outlet.*

To Remove Machine From Cabinet:

1. Tilt machine back until it rests on hinges. Remove machine plug from receptacle.

NOTE: On models equipped with spring-assist plate (see inset, Step 1), remove screw which fastens clip to machine. Remove electrical cord from clip, then replace clip and screw (to avoid loss of these items).

2. Loosen set screws that hold machine on hinge pins by turning them counter-clockwise.
3. Lift machine straight up and off pins. For ease of removal, stand behind cabinet when lifting machine.

To Replace Machine in Cabinet:

Reverse the procedure used for removing the machine.

- Be sure set screws in machine are unscrewed far enough to clear the openings for the hinge pins.
- To keep hinge pins pointing up while replacing the machine, slip an elastic rubber band around both pins, making sure the elastic band is over the shoulder of each hinge as illustrated.
- *Be sure set screws are firmly tightened against hinge pins before lowering machine into sewing position or into storage position.*

NOTE: On Models equipped with spring-assist plate, lead electrical cord into recess at bottom of plate; fit clip on cord and fasten to machine, as shown in inset, Step 1.

performance checklist

REMEMBER TO

- Turn on power and light switch.
- Turn hand wheel toward you to position needle and take-up lever.
- Raise needle above fabric before making adjustments to stitch width, needle position and pattern selector.
- Use red selector settings for *Flexi-Stitch* pattern sewing.
- Start and finish sewing with the take-up lever in its highest position.
- Adjust stitch length, pressure, and thread tension to suit your fabric.
- Test-stitch on a fabric sample before starting a sewing job.
- Replace bent or burred needles.
- Lower presser foot before setting pressure dial.
- Tighten hand wheel knob and move bobbin winder switch to OFF after winding a bobbin.
- Remove feed-cover needle plate after button sewing and after darning with an embroidery hoop.
- Sew at a moderate speed when using a *Flexi-Stitch* pattern.

IF THREAD BREAKS, MAKE SURE

- Machine is correctly threaded.
- Bobbin case is correctly inserted and threaded.
- Bobbin case area is free of lint and loose thread ends.
- Needle is straight and securely tightened in clamp.
- Thread is suitable for size of needle.
- Thread is even and free of knots.
- Needle-thread tension is light enough.
- Needle-plate needle hole and presser foot are undamaged.
- Bobbin and bobbin case are undamaged.

Enjoy Sewing!

If you have any questions, please write to:

Department of Sewing Education

The Singer Company

321 First Street, Elizabeth, N.J. 07207

FASHION AIDS

special accessories for special jobs

The *Fashion Aids* shown below are designed to increase the versatility of your sewing machine. They are part of the complete selection of accessories that is available at your local Singer Sewing Center.

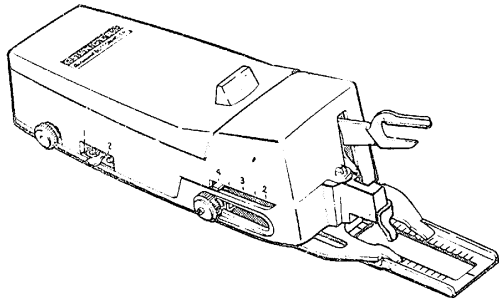

Professional* Buttonholer No. 102878 sews six kinds of buttonholes, plus eyelets, in a wide variety of fabrics.

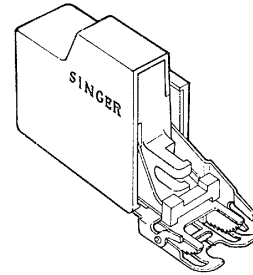

Even Feed Foot No. 507806 is an invaluable aid for sewing hard-to-feed vinyls and fake fur, pile, stretch, bonded and laminated fabrics.

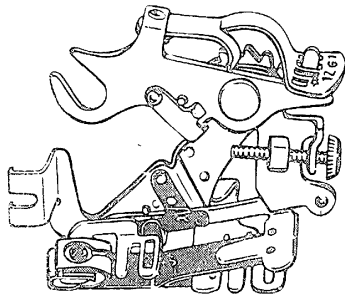

Ruffler No. 86742 offers a simple, effective way to make gathered and pleated ruffles. Used for straight stitching only.

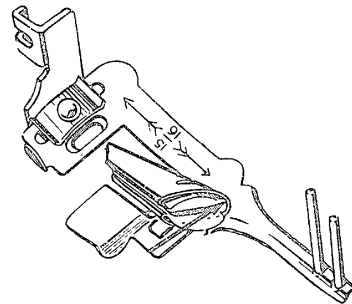

Binder Foot No. 81245 is used to apply ready-made bias tape or unfolded bias binding to an unfinished fabric edge.

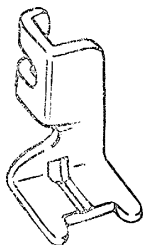

Button Foot No. 161613 holds any two-hole or four-hole button securely for stitching.

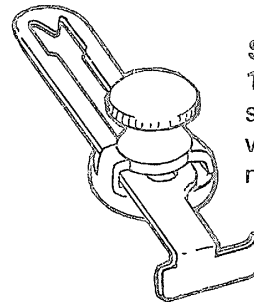

Seam Guide No. 161172 helps keep seam width uniform when extra control is needed.



Hemmer Foot No. 161671 is used for turning and stitching narrow hems in one operation.

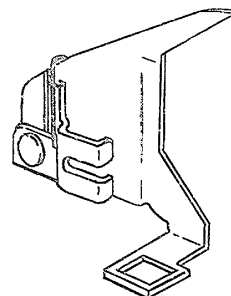

Darning and Embroidery Foot No. 161876 is ideal for embroidery, monogramming and decorative designs.

your personal measurement chart

This chart will enable you to keep a record of your measurements. Have someone assist you in taking the measurements carefully with an accurate tape measure. The illustrations below show where the tape measure should be placed when taking each measurement.

- | | Inches |
|--|--------|
| 1. BUST — Fullest part — slightly higher in back .. | |
| 2. WAIST — Around natural waistline .. | |
| 3. HIP — inches below natural waistline (fullest part) .. | |
| 4. SHOULDER — From base of neck to top of arm .. | |
| 5. FRONT BODICE WIDTH — From armhole to armhole 5 inches down from center shoulder .. | |
| 6. BACK BODICE WIDTH — From armhole to armhole 4 inches down from center shoulder .. | |
| 7. SHOULDER TO BUST — From neck base at shoulder to a line even with point of bust .. | |
| 8. FRONT WAIST LENGTH — From neck base at shoulder over fullest part of bust to waistline .. | |
| 9. BACK WAIST LENGTH — From the prominent bone at base of neck to natural waistline .. | |
| 10. SLEEVE WIDTH — Around arm at upper edge of underarm seam .. | |
| 11. SLEEVE LENGTH — Shoulder to elbow .. | |
| 12. SLEEVE LENGTH — Elbow to wrist .. | |
| 13. FRONT SKIRT LENGTH — Down center from waistline to hem .. | |
| 14. BACK SKIRT LENGTH — Down center from waistline to hem .. | |
| SLACKS MEASUREMENT CHART | |
| 15. FULL LENGTH — Waist to floor at side seam .. | |
| 16. SLACKS LENGTH — Waist to ankle .. | |
| 17. CROTCH SEAM (standing) — .. | |
| 18. CROTCH SEAM (seated) — Waist to chair at side seam .. | |

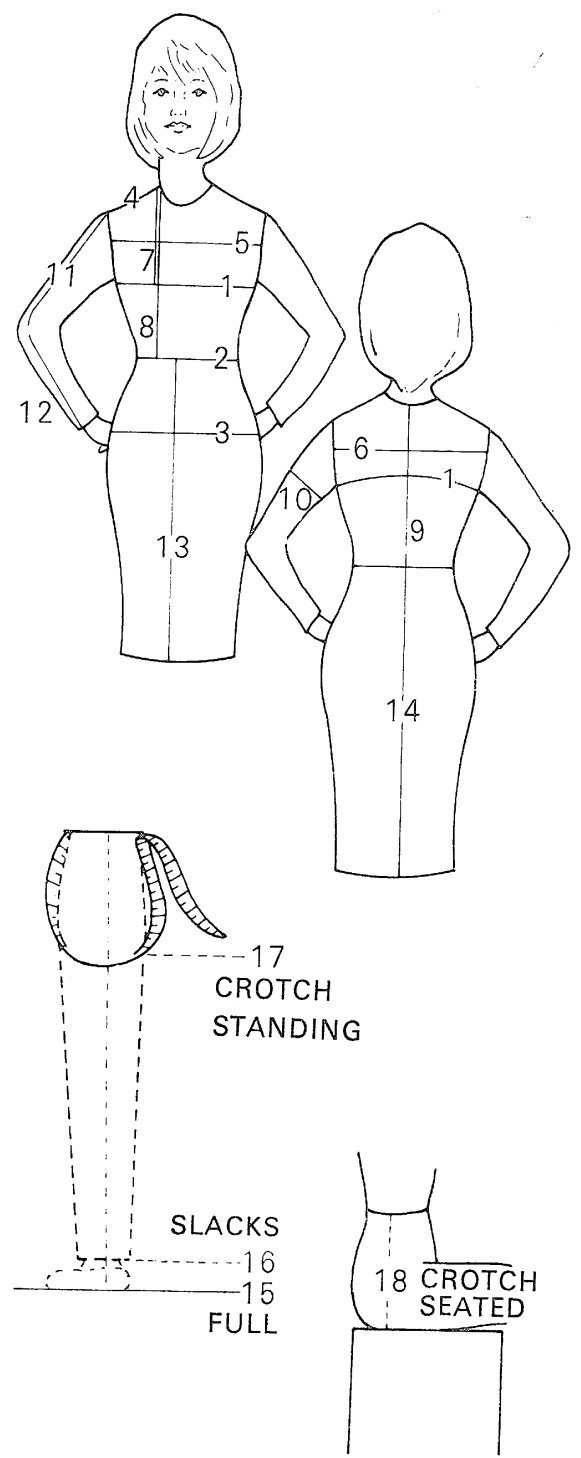

INDEX

	Page		Page
Accessories	6	Pin Basting	19
Appliqué	46	Power and Light Switch	5
Blindstitch Hems	44	Presser Foot	3, 6
Bobbin	5, 8, 11	Changing	7
Winding	11	Presser Foot Lifter	3
Bobbin Case		Pressure Adjustment	18
Removing and Replacing	54	Pressure Regulating Dial	3, 18
Threading	13	Principal Parts	2
Buttonholes	32	Reverse Stitching	17
Buttons	31	Satin Stitching	25
Carrying Case Base		Seams, Sewing	19
Removing and Replacing	53	Corded	42
Checklist	57	Finishes	38
Cleaning	52	Ladder	38
Darning	50	Lingerie	39
Darts	45	Overedged	37
Elastic, Attaching	37	Straight	20
Electrical Speed Controller	5, 9	Shell Edging	47
Embroidering	51	Slide Plate	3, 55
Fabric, Thread and Needle Table	10	Special Fabrics, Sewing	40
Face Plate		Special Purpose Foot	6, 24, 25, 46
Removing and Replacing	53	Spool Pin	3
<i>Fashion Aids</i>	58	Stitch Length	4, 17, 24, 25, 28
Feed Cover Needle Plate	7	Stitch Pattern Selector	4
Feed	3	Setting	22, 26
Finishes for Hems and Facings	38	Stitch Width Selector	4, 16, 23, 27
<i>Flexi-Stitch</i> Pattern Dial	3, 16, 22, 26, 28	Straight Stitching	16
Free Motion Stitching	51	Adjusting Selectors	17
General Purpose Foot	6	Stretch Fabrics, Sewing	35
Guiding and Supporting Fabric	21, 36	Take-up Lever	3
Hand Wheel	3	Tension Adjusting	3
Hand Wheel Knob	5	For Straight Stitching	18
Hems, Blindstitch	44	For Zig-Zag Stitching	23, 25, 27
Knit Fabrics, Sewing	35	Thread	10
Light Bulb	55	Thread Cutter	3
Lubrication	52	Threading the Machine	11, 30
Mending	48	Topstitching	45
Needle	8	Twin Needle	8
Changing	8	Twin-Needle Stitching	29
Threading	14	Zig-Zag Stitching	22
Twin Needle	8, 29	Needle Position	23, 27
Needle Clamp	3, 8	General Purpose Foot	6
Needle Plate	3, 6, 7	Satin Stitching	25
Changing	7	Stitch Pattern Selector	22, 26
Needle Position Selector	4, 23, 27	Stitch Length	24, 25, 28
Oiling	52	Stitch Width	23, 27
		Zipper Foot	6, 42
		Zippers	42
		Blindstitch	43
		Straight Stitch	42

Dear Customer :

We recommend that for future reference you record the Serial Number of your Sewing Machine in the space provided.

*Refer to illustration
at right for location
of Serial Number on
your machine.*

Serial No.

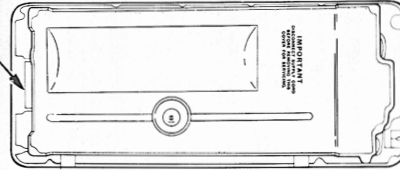

Serial No.



Here, there, everywhere... **SINGER**

BEAUTIFUL & PRACTICAL

SINGER

SEWING MACHINE CABINETS

With the home sewer's needs in mind, Singer combines expert craftsmanship with imaginative design in sewing machine cabinets that provide both

comfortable and ample work space. Shown here are just a few of the contemporary and traditional styles available.

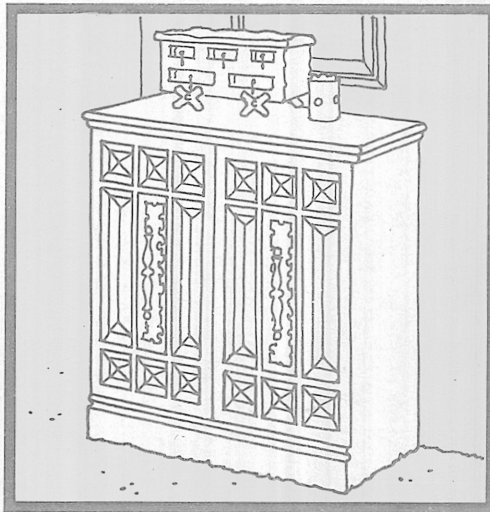

Beautiful carving and handsome hardware enhance the Mediterranean look of the Monaco.

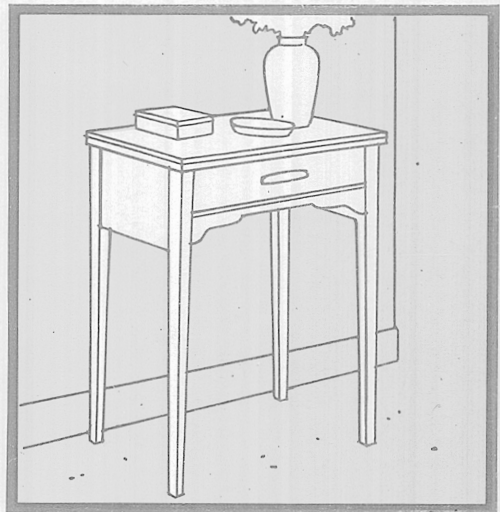

Sleek lines and rich walnut veneers make the Pacesetter an elegant addition to any room.

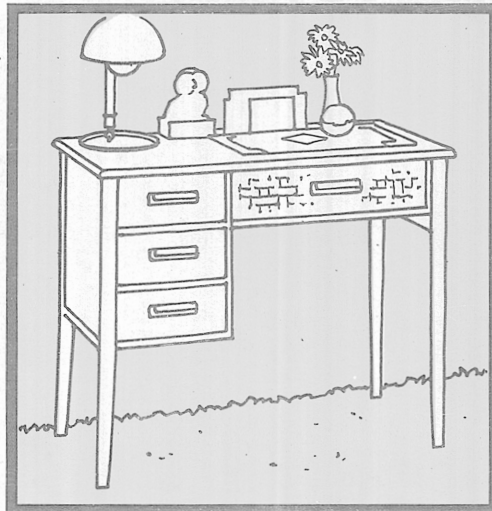

Basketwork design adds a handcrafted mellowness to the trim, modern lines of the Greenbrier.



The warmth of Early American design distinguishes the maple-toned Saratoga cabinet.

Chairs and benches in coordinated wood tones are also available.