

Form 19721
(Rev. 641)

INSTRUCTIONS
FOR USING
SINGER
ELECTRIC SEWING MACHINE
(P. G. Built-on Motor)

15-91

REVERSIBLE FEED
LOCK STITCH, FOR FAMILY USE

When Requiring
Needles, Oil,
Parts or
Repairs for
Your Machine



Look for the
Red "S"
There are
Singer Shops in
Every City

THE SINGER MANUFACTURING CO.

PRINTED IN U. S. A.

**THE IMPORTANCE OF USING
SINGER LUBRICANTS FOR YOUR
ELECTRIC SEWING MACHINE**

“The Best is the Cheapest”

Use Singer Oil on Machine

Knowing from many years' experience the great importance of using good oil, we put up an extra quality machine oil, in cans, especially prepared for sewing machines.

Use Singer Lubricant on Motor

The Singer Motor Lubricant is especially prepared for lubricating the gears and bearings of the electric motor. This is a pure non-flowing compound which retains its consistency and possesses high lubricating qualities.

PRINTED IN U. S. A.

Copyright, U. S. A., 1915, 1920, 1921, 1923, 1924, 1926,
1928, 1931, 1932, 1933, 1935, 1936, 1938, 1939, 1940 and 1941
by The Singer Manufacturing Co.
All Rights Reserved for all Countries

19721

INSTRUCTIONS FOR USING
SINGER
ELECTRIC SEWING MACHINE

(P. G. Built-on Motor)

15-91

REVERSIBLE FEED
OSCILLATING SHUTTLE, FOR FAMILY USE

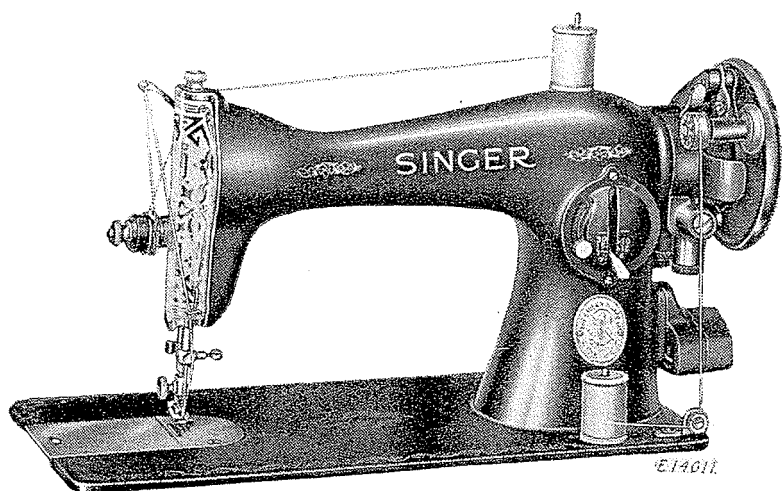

MACHINE 15-91

THE SINGER MANUFACTURING COMPANY

To all whom it may concern:

The placing or renewal of the name "Singer" (Reg. U. S. Pat. Off.) or any of the trade marks of The Singer Manufacturing Company on any machine that has been repaired, rebuilt, reconditioned, or altered in any way whatsoever outside a Singer factory or an authorized Singer agency is forbidden.

Genuine Singer Needles should be used
in Singer Machines.
These Needles and their Containers
are marked with the
Company's Trade Mark "SIMANCO." 1

Needles in Containers marked
"For Singer Machines"
are not Singer made needles. 2

DESCRIPTION

Machine 15-91, for family use, has an oscillating shuttle and makes the lock stitch.

It has reverse feeding mechanism by means of which the machine stitches as readily in a reverse direction as it does in a forward direction.

It is especially designed for operation by electricity, having an electric motor built on the back of its arm. The motor drives the machine through spiral gears.

It is also equipped with an electric Singerlight.

Before starting to darn or embroider, make the simple adjustment on the machine, as instructed on page 33.

SINGER SERVICE

Now that you have purchased your new Singer, we do not want you to feel that your relations with us have come to an end. You are cordially invited to visit your Singer Shop at any time for assistance in your sewing problems. You will be most welcome.

We hope, too, that you will make the Singer Shop your headquarters for sewing supplies and service. Only there or through authorized bonded Singer representatives can you secure genuine Singer oil, needles, belts, parts, etc., so important in getting the best results from your machine. And remember, only an authorized Singer representative should be allowed to touch your machine when repairs or adjustments are required.

World-wide Singer Service has no equal. Use it!

Motor Can be Operated on Either Alternating Current or Direct Current

The electric motor, which is located at the back of the machine, can be operated on either alternating current or direct current, as desired. The standard windings of the motor are for 110 volts, and motors can be furnished for any voltage between 100 and 250.

Special motors for 32 volts direct current, and for 50 volts alternating current and direct current, have also been developed and are available.

Points to Determine Before Connecting Motor to Electric Service Line

Obtain the following information from the Electric Light Company which supplies the electric current for the circuit to which the motor is to be connected:

1. If current is direct, what is the voltage? The voltage must be within the range stamped on the name plate of the motor.
2. If current is alternating, in addition to the voltage, what is the number of cycles? The number of cycles must be within the range stamped on the name plate of the motor.

The voltage of any circuit and, if alternating current, the number of cycles, can be verified by looking at the name plate on service watt meter installed by the local Electric Light Company.

To Connect the Machine to Electric Service Line

Push the terminal plug at one end of the electric cord as far as it will go on the three-pin terminal block at the right of the machine. Attach the plug at the other end of the cord to the nearest electric light socket and the machine is ready for operation.

To Insure Perfect Action of the Machine

The balance wheel must always turn over toward the operator.

Do not run the machine with the presser foot resting on the feed without cloth under the presser foot.

Do not run the machine when both bobbin case and needle are threaded, unless there is material under the presser foot.

Do not try to help the machine by pulling the fabric, lest you bend the needle. The machine feeds the work without assistance.

The slide over the bobbin case should be kept closed when the machine is in operation.

To Turn Singerlight "On" or "Off"

Reach under the machine arm and move the switch (A, Fig. 2) to the right or left as desired.

CAUTION

When you have finished your sewing, always disconnect the plug from the electric socket.

To Remove and Replace the Bulb

Do not attempt to unscrew the bulb. It is of the bayonet and socket type and does not unscrew.

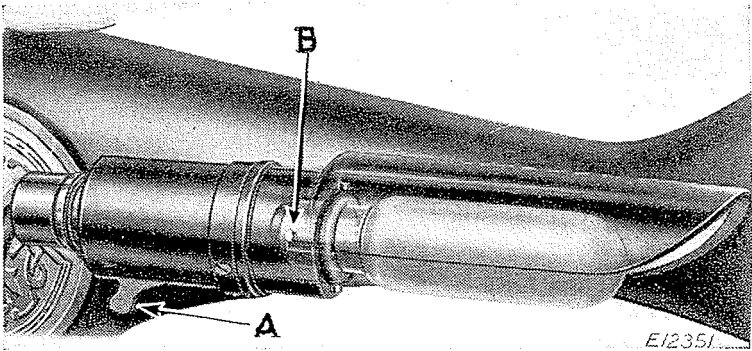

FIG. 2

To remove the bulb. Having turned the shade slightly, hold the Singerlight socket with one hand and with the other hand press the bulb into the socket and at the same time turn the bulb over from the machine as far as it will go, then withdraw the bulb.

To insert a new bulb. Hold the socket with one hand and at the same time with the other hand press the bulb into the socket and turn it over toward the machine until the bulb pin (B, Fig. 2) enters the notch in the socket, then return the shade to its normal position, as shown in Fig. 2.

To Operate the Machine

Raise the presser foot (B) by means of the presser bar lifter (C) to prevent injury to the foot (B) and feed (A).

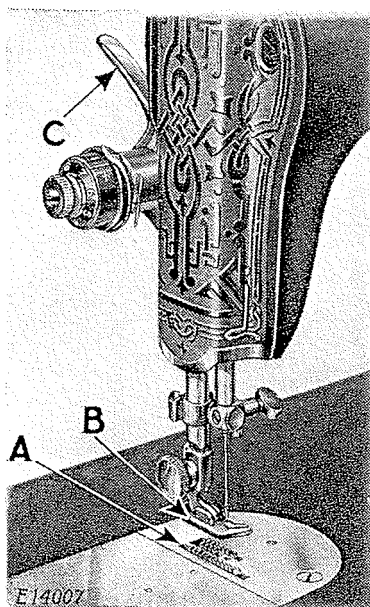

FIG. 3. FRONT VIEW OF THE MACHINE

Place a piece of cloth under the presser foot and let the foot down upon it.

Turn on the electric current and, if the combination knee and foot controller is installed as a knee controller, press the controller to the right, or, if the controller is placed on the floor to be used as a foot controller, press down on the pedal of the controller. As the pressure on the controller is increased, the speed of the machine is increased, the speed being controlled entirely by the amount of pressure on the controller. Operate the machine in this way, without being threaded, until you have become accustomed to guiding the material and operating the controller.

To Remove the Bobbin

Turn the balance wheel over toward you until the thread take-up lever (5, Fig. 12) is raised to

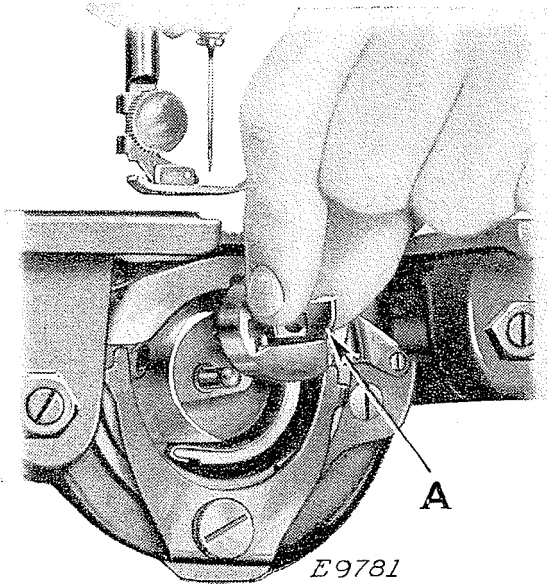

FIG. 4. REMOVING THE BOBBIN CASE

its highest position. Draw to the left the slide in the bed of the machine. Reach down with the thumb and forefinger of the left hand, open the bobbin case latch (A, Fig. 4) and lift out the bobbin case. While the latch remains open, the bobbin is retained in the bobbin case. Release the latch, turn the open end of the bobbin case downward and the bobbin will drop out.

To Wind the Bobbin

It is necessary to understand the stop motion (C, Fig. 5) by which the balance wheel (B, Fig. 5) can be released when required, thus permitting the winding of bobbins without running the stitching mechanism.

Release the balance wheel by turning the stop motion screw (C) over toward you. It is necessary to hold the balance wheel while loosening the stop motion screw.

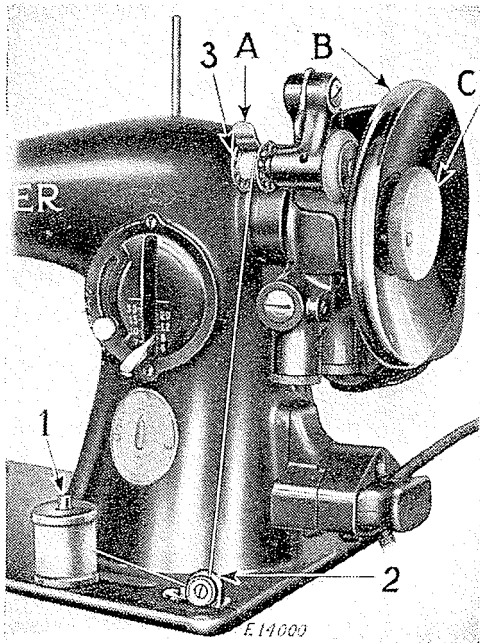

FIG. 5. WINDING THE BOBBIN

Place the bobbin on the bobbin winder spindle and push it up closely against the shoulder, having the small pin in the shoulder enter the hole in the side of the bobbin. Put the spool of thread on the spool pin (1). Draw the thread under and between the tension discs (2) on the bed of the machine, then pass the thread up and through one of the holes (3) in the left side of the bobbin, from the inside. Press down on the bobbin and the bobbin winder latch (A, Fig. 5) will drop down and hold the bobbin winder pulley against the hub of the balance wheel. Then press the knee controller or the foot controller the same as for sewing.

The end of the thread must be held by hand until a few coils are wound and should then be broken off. When sufficient thread has been wound upon the bobbin, the bobbin winder is automatically released from the balance wheel.

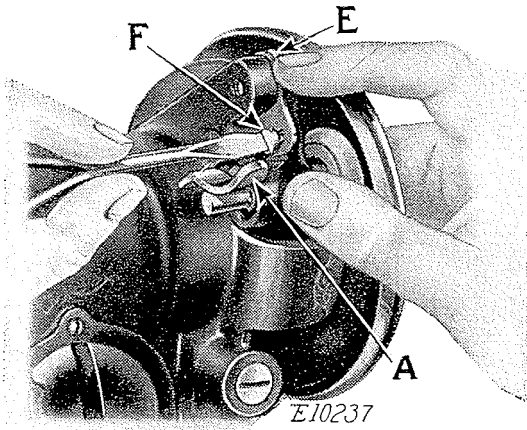

FIG. 6. ADJUSTMENT OF BOBBIN WINDER

If the pressure of the bobbin winder pulley against the hub of the balance wheel is insufficient for winding the bobbin, press down the bobbin winder until the latch (A) drops and holds it, then loosen the adjusting screw (F). With the forefinger, push back the upper end of the slotted plate (E) as far as it will go, as shown in Fig. 6, and at the same time press the bobbin winder pulley against the hub of the balance wheel, then tighten the adjusting screw (F).

If the thread does not wind evenly on the bobbin, loosen the screw which holds the tension bracket (2, Fig. 5) in position on the bed of the machine and slide the tension bracket to the right or left, as may be required, then tighten the screw.

Bobbins can also be wound while the machine is sewing.

To Thread the Bobbin Case

Hold the bobbin between the thumb and forefinger of the right hand, with the thread on top drawing from right to left, as shown in Fig. 7.

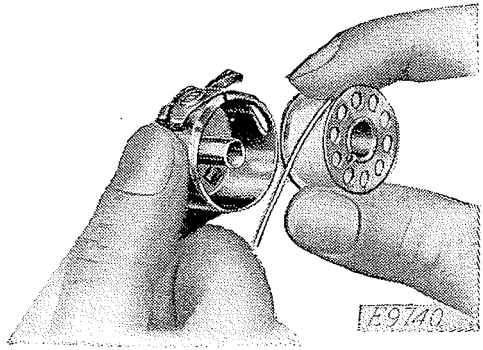

FIG. 7

With the left hand hold the bobbin case as shown in Fig. 7, the slot in the edge being at the top, and place the bobbin into the bobbin case.

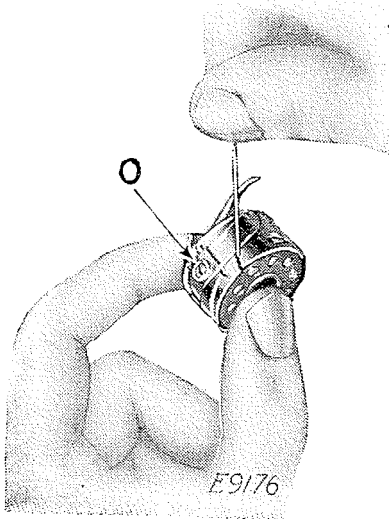

FIG. 8

Then pull the thread into the slot as shown in Fig. 8, and back under the tension spring into the slot at the end of the tension spring as shown in Fig. 9.

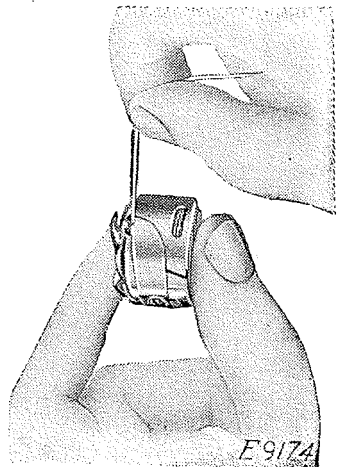

FIG. 9

To Replace the Bobbin Case

After threading, take the bobbin case by the latch, holding it between the thumb and forefinger

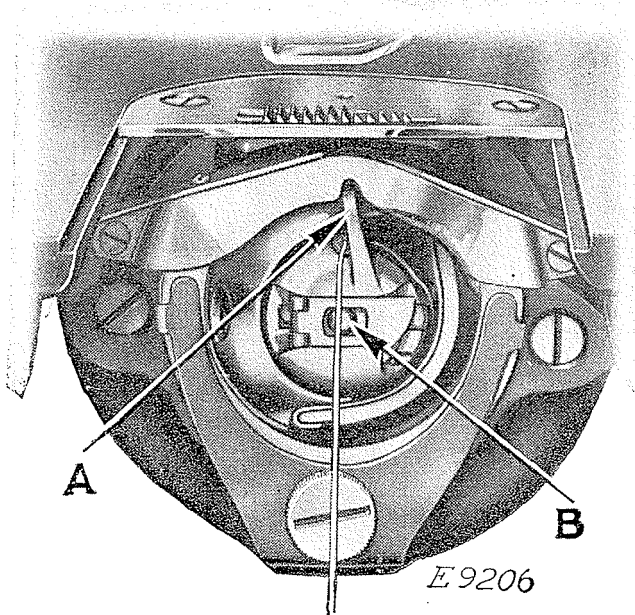

FIG. 10. BOBBIN CASE THREADED AND REPLACED

of the left hand. Place the bobbin case on the center stud (B, Fig. 10) of the shuttle body with the position finger (A, Fig. 10) opposite the notch at the top of the shuttle race. Release the latch and press the bobbin case back until the latch catches the groove near the end of the stud. Allow about three inches of thread to hang free from the bobbin case and close the slide in the bed of the machine.

To Set the Needle

Select a needle to suit the size of thread being used. See inside cover page at back of book.

Turn the balance wheel over toward you until the needle bar is at its highest position, and loosen the thumb screw (A, Fig. 11) in the needle clamp.

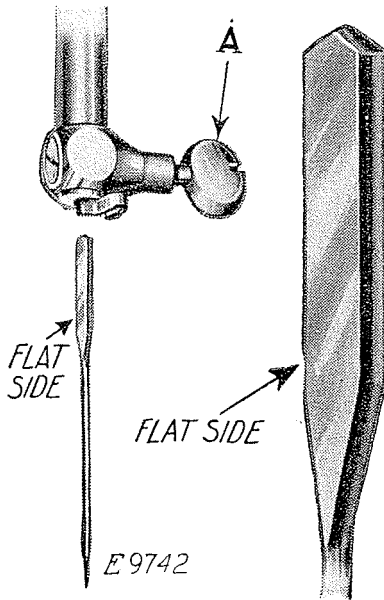

FIG. 11. POSITIONING OF NEEDLE
IN NEEDLE CLAMP

Have the flat side of the shank of the needle toward the left as shown above and put the needle up into the clamp as far as it will go. Then tighten the thumb screw.

Upper Threading

(SEE FIG. 12)

Turn the balance wheel over toward you until the thread take-up lever (5) is raised to its highest position. Place the spool of thread on the spool pin at the top of the machine and pass the thread to the left through the thread guide (1) at the rear of the face plate, down, under and from back to front between the tension discs (2), the thread guard (L) guiding the thread between the discs. (See insert in Fig. 12). With the right hand hold the spool to prevent it from turning, and with the left hand draw the thread up into the take-up spring (4) until the thread enters the retaining fork (3), then pass the thread up and from back to front through the hole in the thread take-up lever (5), down through the guide (6) on the face plate, into the guide (7) on the needle clamp and from **right to left** through the eye (8) of the needle.

Draw about two inches of thread through the eye of the needle with which to commence sewing.

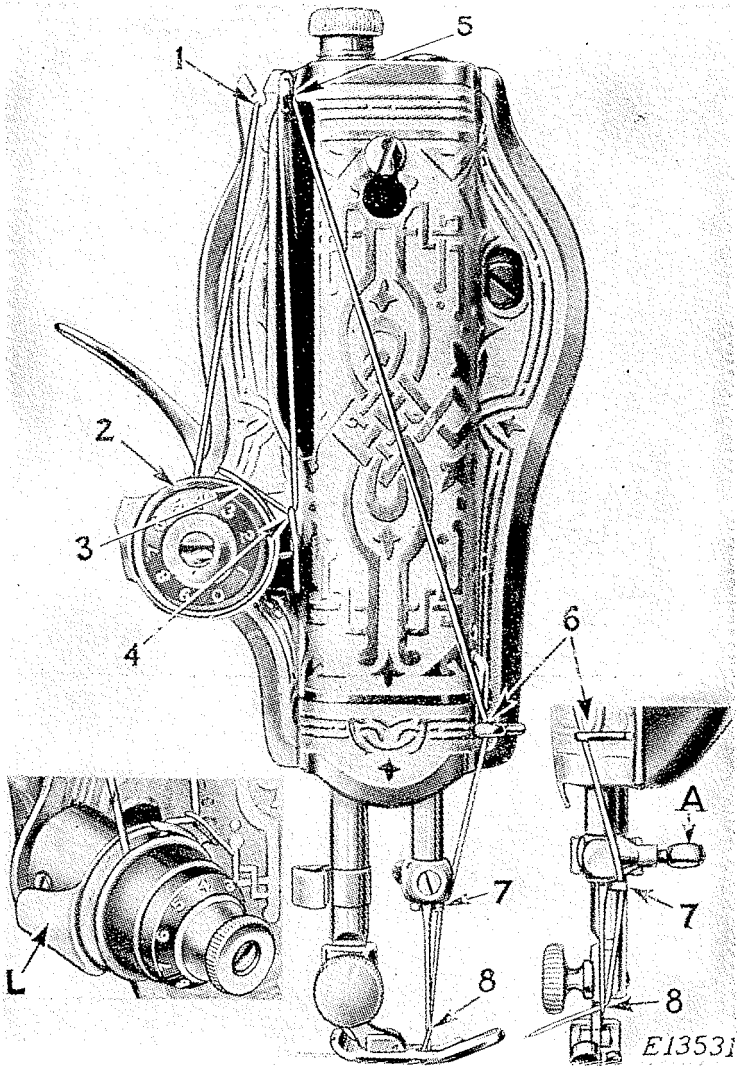

FIG. 12. UPPER THREADING

To Prepare for Sewing

With the left hand hold the end of the thread, leaving it slack from the hand to the needle. Turn

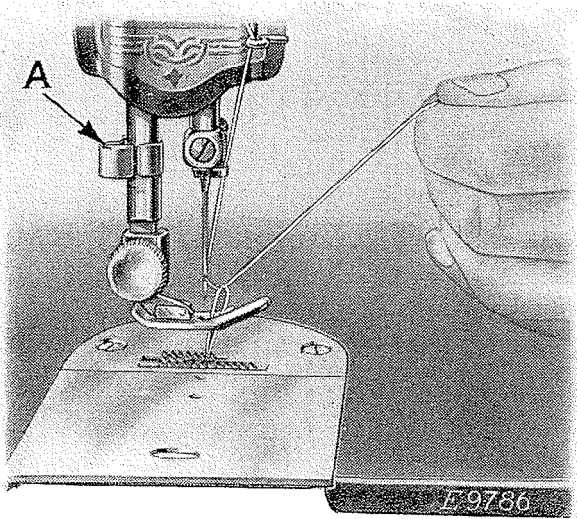

FIG. 13. DRAWING UP THE BOBBIN THREAD

the balance wheel over toward you until the needle moves down and then up to its highest position, thus catching the bobbin thread. Draw up the needle thread and the bobbin thread will come up with it through the hole in the throat plate, as shown in Fig. 13. Lay both threads back under the presser foot.

To Commence Sewing

Place the material beneath the presser foot, lower the presser foot and commence to sew.

When sewing thick material, it may be necessary to turn the balance wheel over toward you to start the machine. This should also be done if the machine stops when sewing across thick seams.

To Remove the Work

Stop the machine with the thread take-up lever (5, Fig. 12) at its highest position, raise the presser foot and draw the fabric back and to the left, pass the threads over the thread cutter (A, Fig. 13) and pull down lightly to sever them. Leave the ends of the threads under the presser foot.

To Turn a Corner

Stop the machine when the needle is commencing its upward stroke. Raise the presser foot and turn the work as desired, using the needle as a pivot, then lower the presser foot.

To Regulate the Pressure on the Material

For ordinary family sewing, it is seldom necessary to change the pressure on the material. If sewing fine silk or flimsy material, lighten the pressure by turning the thumb screw (A, Fig. 24) on the top of the machine over to the left so that it screws up. To increase the pressure, turn this thumb screw over to the right so that it screws down. The pressure should be only heavy enough to prevent the material from rising with the needle and to enable the feed to move the work along evenly. The heavier the material, the heavier the pressure; the lighter the material, the lighter the pressure.

To Regulate the Direction of Feed

To feed the goods **from you**, push down the stitch regulator lever (B, Fig. 14) as far as it will go.

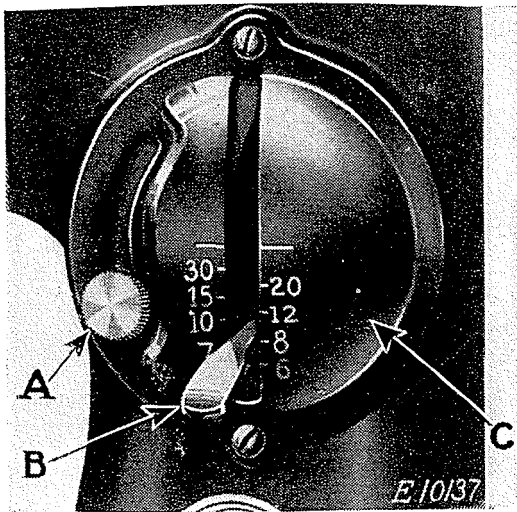

FIG. 14. SHOWING LEVER FOR REVERSING DIRECTION OF FEED AND REGULATING LENGTH OF STITCH

To feed the goods **toward you**, raise the stitch regulator lever (B) as high as it will go.

The direction of feed can be reversed at any point of a seam without removing the work from the machine.

Back tacking is therefore readily accomplished and the fastening of the ends of seams is made easy.

To Regulate the Length of Stitch

The machine can be adjusted to make from 6 to 30 stitches to the inch as indicated by the numerals on the stitch indicator plate (C, Fig. 14).

The number of stitches to the inch that the machine is set to make is indicated by the number which is in line with the upper side of the stitch regulating lever (B, Fig. 14).

To change the length of stitch, loosen the thumb screw (A, Fig. 14) and move it to the bottom of the slot. Then move the stitch regulating lever (B) until its upper side is in line with the number of the desired length of stitch. Now move the thumb screw (A) until the stitch regulating plate touches the lever (B), then tighten the thumb screw (A).

The machine will now make the indicated number of stitches to the inch in either a forward or reverse direction, depending on whether the lever (B) is at its lowest or highest position.

Basting

The longest stitch made by the machine, No. 6 on the stitch indicator, is found satisfactory for basting, after loosening the tension on the needle thread so that the stitches may be easily pulled from the material.

Machine basting is firmer and more even than that done by hand in addition to being much quicker.

To Sew Flannel or Bias Seams

Use a short stitch and as light a tension as possible on the needle thread so as to leave the thread loose enough in the seam to allow the goods to stretch if necessary.

Tensions

For ordinary stitching, the needle and bobbin threads should be locked in the center of the thickness of the material, thus:

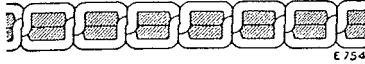

FIG. 15. PERFECT STITCH

If the tension on the needle thread is too tight, or if that on the bobbin thread is too loose, the needle thread will lie straight along the upper surface of the material, thus:

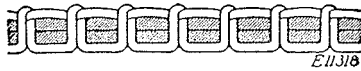

FIG. 16. TIGHT NEEDLE THREAD TENSION

If the tension on the bobbin thread is too tight, or if that on the needle thread is too loose, the bobbin thread will lie straight along the under side of the material, thus:



FIG. 17. LOOSE NEEDLE THREAD TENSION

To Regulate the Needle Thread Tension

The tension on the needle thread can be regulated only when the presser foot is down.

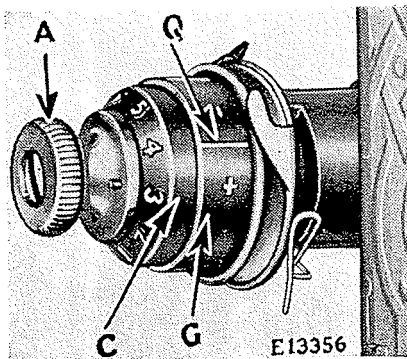

FIG. 18. NEEDLE THREAD TENSION

The numbered dial (C, Fig. 18) is marked with numbers ranging from 0 to 9, which indicate different degrees of tension which can be produced. The numbers do not denote a particular size of thread.

By noting the number which is op-

posite the center line (Q) on the indicator (G) when set for a satisfactory tension on the work being stitched, the number can be readily reverted to when a change is made in the tension or size of thread.

To Increase the Tension, turn the thumb nut (A) over toward you (over to the right) until the desired number on the numbered dial (C) is opposite the center line (Q), the higher numbers denoting increased tension.

To Decrease the Tension, turn the thumb nut (A) over away from you (over to the left), the lower numbers indicating less tension.

The tension indicator (G) is marked with the signs + and —, which indicate the direction in which to turn the thumb nut (A) for more or less tension.

CAUTION—It is important for the tension thumb nut (A, Fig. 18) to have a firm fit on tension stud (N, Fig. 19), to keep the numbered dial (C) in the position set for the required tension. To remedy a loose fit of the nut, remove parts A, C, D, F and G, Fig. 20, and slightly spread the stud, then re-assemble the parts as instructed on pages 22 to 24 inclusive.

To Regulate the Bobbin Thread Tension

The tension on the bobbin thread is regulated by the screw (O, Fig. 8) in the bobbin case tension spring. To increase the tension, turn this screw over to the right. To decrease the tension, turn the screw over to the left.

When the tension on the bobbin thread has once been properly adjusted, it is seldom necessary to change it, as a correct stitch can usually be obtained by varying the tension on the needle thread.

To Disassemble the Needle Thread Tension

NOTE: The needle thread tension, Figs. 18 to 20 inclusive, is correctly adjusted at the factory to produce the complete range of tensions with one revolution of the thumb nut (A).

There should be no necessity for removing or taking this tension apart. However if, for any reason, it becomes necessary to remove the tension, proceed as follows:

Turn the thumb nut (A, Fig. 19) away from you (toward the left) until it stops at "0" on the num-

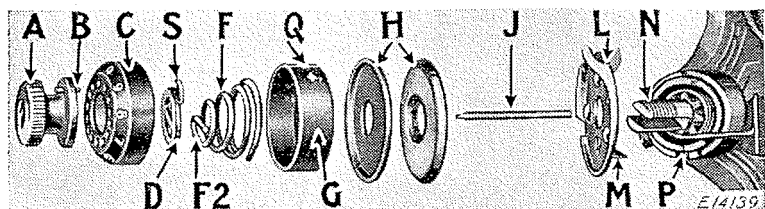

FIG. 19. NEEDLE THREAD TENSION DISASSEMBLED

bered dial (C); then press in the dial to disengage the pin (B) in the thumb nut and remove the thumb nut, dial, stop washer (D), tension spring (F), indicator (G), the two tension discs (H), thread guard plate (L), and the tension releasing pin (J), as shown in Fig. 19. To remove the pin (J) from the stud (N), take off the face plate and tilt it so that the pin will drop out.

To Reassemble the Needle Thread Tension

Replace the face plate, insert the tension releasing pin in the stud, place the thread guard plate on the

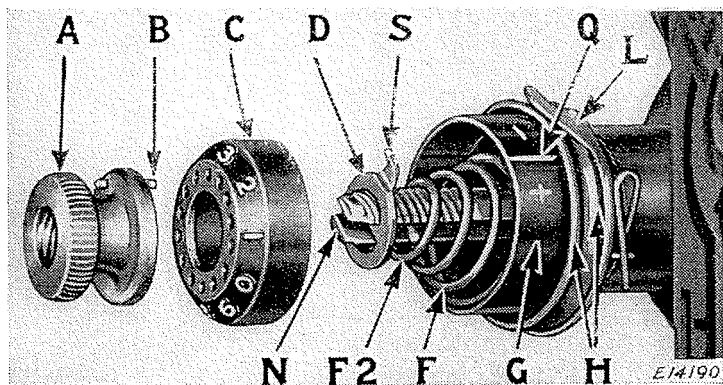

FIG. 20. REASSEMBLING AND REPLACING THE TENSION

stud, being sure that the lug (M, Fig. 19) engages the short recess (P) to prevent the plate from turning on the stud. Next, place the two tension discs (H) on the stud, having the flat thread-bearing sides of the discs together; then replace the indicator (G) with the large open side facing end of stud so that the plus and minus signs will be readily seen from a sewing position as shown in Fig. 20. Insert the tension spring (F) in the indicator so that the first half turn of this spring will straddle the lower half of the tension stud. Guide the stop washer (D) onto the stud so that the extension (S) will be above the tension stud as shown in Fig. 20.

If the spring and stop washer are in correct position, the extension will clear the first half coil of the spring as shown in Fig. 21.

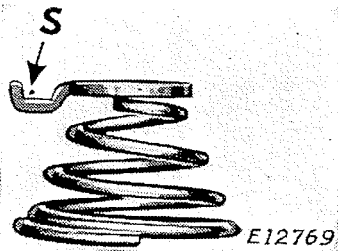

FIG. 21

Next place the numbered dial on the stud so that the numeral 2 is opposite the stop washer extension (S), then push the dial to compress the spring so that the thumb nut can be turned

onto the stud, carefully guiding the pin in the thumb nut into one of the holes in the numbered dial. Then lower the presser bar and turn the thumb nut (A) to the left until it stops at "0." Thread the tension and pull the thread through the tension discs to test the amount of tension at the "0" position. At this

point there should be a barely perceptible pull on the thread to indicate that there is a minimum tension on the thread, which gradually increases with the turn of the thumb nut to the right, providing a full range of tensions from light to heavy within one revolution of the thumb nut. If the pull is too strong for a minimum tension, press in the numbered dial to disengage the pin in the thumb nut from the dial and reset the pin in one of the holes to the **left** of the previous setting. This resetting of the pin will produce less tension at zero. Repeat this process until the minimum desired tension is obtained. On the other hand, should there be insufficient tension at zero, press in the dial and reset the pin in one of the holes to the **right** of the previous setting, repeating this process until the minimum desired tension is obtained.

If Correct Stitching is Not Obtained:

If the bobbin thread tension has been disturbed, or a correct stitch cannot be obtained without a very heavy or very light needle thread tension, then the following procedure is recommended:

Using No. 50 thread in the needle and on the bobbin, adjust the needle thread tension as instructed above. Then turn the tension thumb nut to "3" and, with two thicknesses of thin material in the machine, adjust the **bobbin thread tension**, as instructed on page 21, until the stitch is correctly locked in the material as shown in Fig. 15.

A wide range of materials and threads can now be accommodated without further adjustment of the bobbin thread tension.

To Oil the Machine

To insure easy running, the machine requires oiling and if used continuously it should be oiled

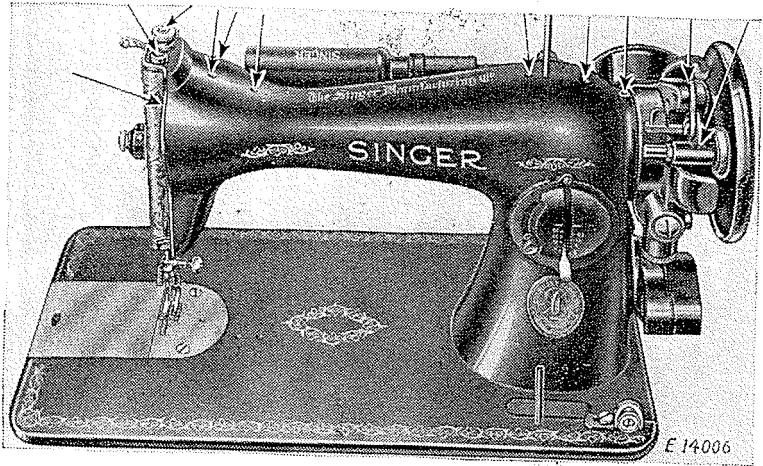

FIG. 22. FRONT VIEW, SHOWING OILING POINTS

each day. With moderate use, an occasional oiling is sufficient. Oil should be applied at each of the places shown by unlettered arrows in Figs. 22 to 25, inclusive. One drop of oil at each point is sufficient. Oil holes are provided in the machine for bearings which cannot be directly reached.

Draw to the left the slide in the bed of the machine and after removing the lint and dust which may have accumulated (see instructions on pages 30 and 31), apply oil to the shuttle race (A, Fig. 27). The slide should then be closed.

At the back of the machine is a round cover plate, fastened by a thumb screw; loosen the

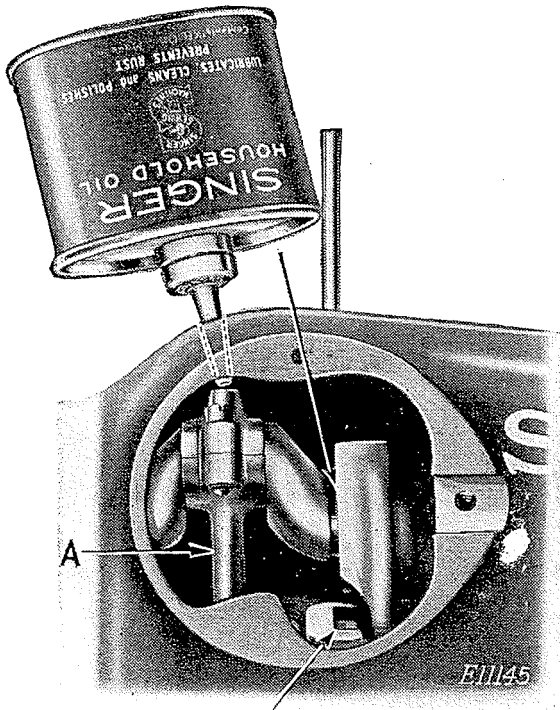

FIG. 23. OILING POINTS AT THE BACK OF THE MACHINE

thumb screw, turn the plate upward and fasten by tightening the screw. Turn the balance wheel over toward you until the connecting rod (A, Fig. 23) is at its highest position. Then apply a few drops of oil through the hole in the top of the machine to the wick which is retained in the cap of the connecting rod, as shown in Fig. 23. Also oil the other moving parts inside, turn the cover plate down and fasten it as before.

Loosen the screw (B, Fig. 24, near the upper end of the face plate, raise the plate and slip it off over the head of the screw. Apply a drop of oil at each of the places indicated by the unlettered arrows in Fig. 24, then replace the face plate and fasten it as before.

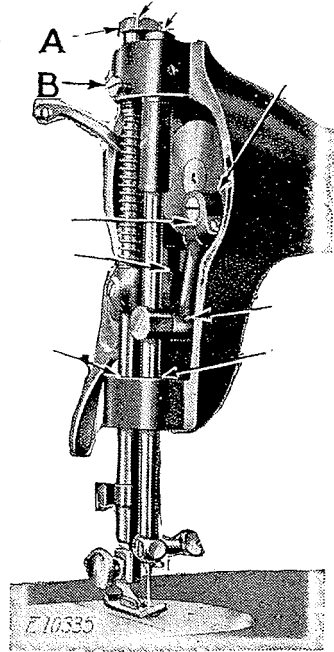

FIG. 24. END VIEW,
SHOWING OILING POINTS

To reach the parts underneath the bed of the machine, turn the machine back on its hinges and apply oil to the oil holes and bearings indicated by the arrows in Fig. 25.

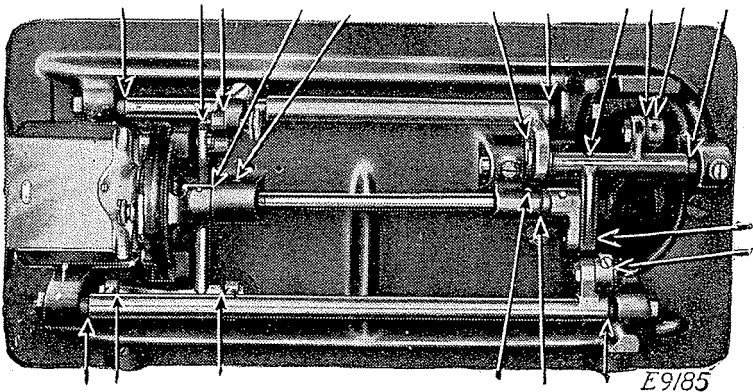

FIG. 25. OILING POINTS IN BASE OF MACHINE

To Lubricate the Motor

USE ONLY SINGER MOTOR LUBRICANT FOR LUBRICATING THE MOTOR. A tube of this lubricant is sent with the machine.

The Singer Motor Lubricant is a specially prepared non-flowing compound which is not affected by varying temperatures. It is the only lubricant which will positively lubricate the motor. Other lubricants, including oil, vaseline or ordinary grease must not be used for lubricating the motor, as they are harmful for this purpose.

When the machine is shipped from the factory, the two motor grease cups (A, Fig. 26) are filled with sufficient Singer Motor Lubricant for approximately one year's use, under ordinary circumstances.

At least once a year thereafter, turn the machine back on its hinges and remove the two thumb screws from the two grease cups (A) and clean out the interior of the cups. Then insert the tip of the motor lubricant tube into the grease cups as shown in Fig. 26, and, while holding the tube firmly against the bottom of the grease cups, **squeeze about a quarter of a tube of the lubricant into each cup**, then replace and tighten the thumb screws.

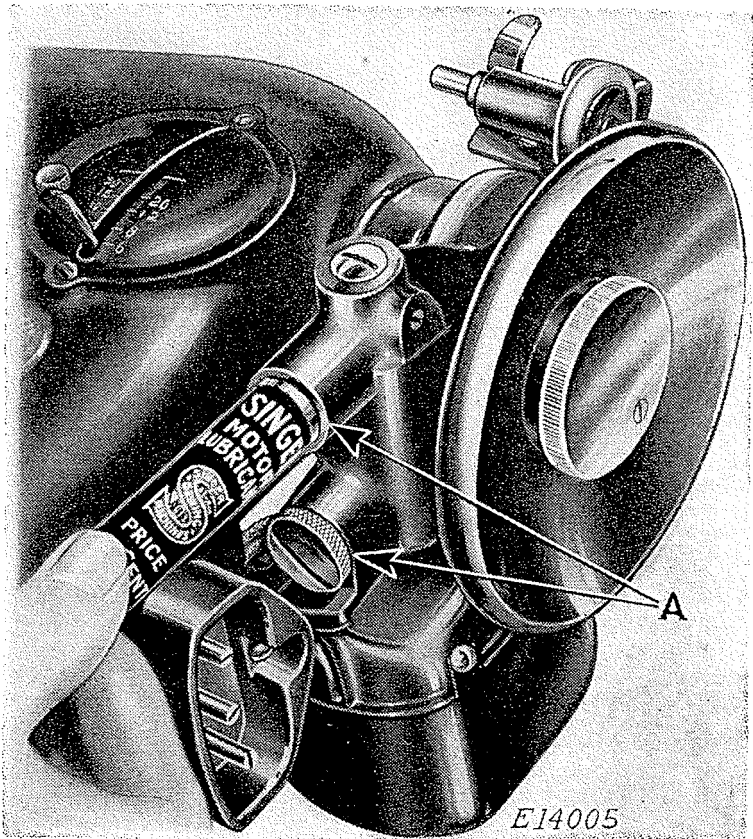

FIG. 26. LUBRICATING THE MOTOR

To Clean the Stitch Forming Mechanism

After considerable use, the stitch forming mechanism in the bed of the machine may become clogged with lint and this may interfere with the perfect operation of the machine.

Occasionally remove the shuttle, as instructed below, and remove the lint, etc., which has accumulated in the machine.

To Remove the Shuttle

Draw to the left the slide in the bed of the machine. Turn the balance wheel over toward you

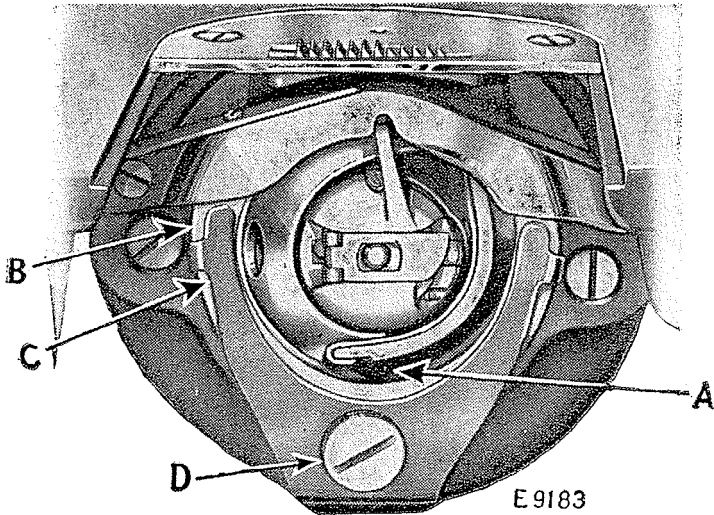

FIG. 27. SHOWING POSITION OF SHUTTLE FOR REMOVAL FROM MACHINE

until the needle is at its highest position and the point of the shuttle is at the position shown in Fig. 27.

Remove the bobbin case and bobbin. Take out the thumb screw (D, Fig. 27), also the spring (C, Fig. 27) and the shuttle race back (B, Figs. 27 and 28). The shuttle (A, Figs. 27 and 28) may now be easily removed and the parts cleaned.

To Replace the Shuttle

See that the needle is at its highest position. Replace the shuttle with its point (A) in the position

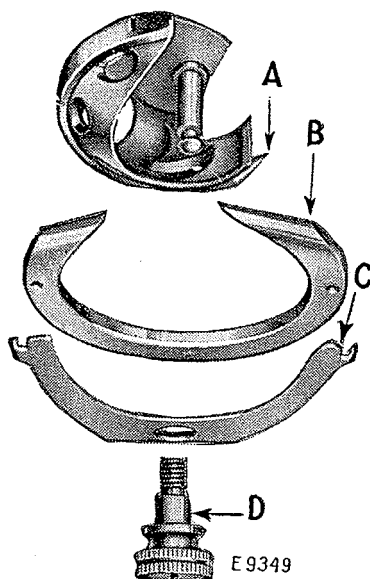

FIG. 28. SHUTTLE AND PARTS REMOVED FROM MACHINE

shown in Fig. 28, then replace the other parts in the order illustrated in Fig. 28. Replace and tighten the thumb screw (D). Replace the bobbin and bobbin case and close the slide in the bed of the machine.

HINTS

Machine Working Heavily. If the machine runs hard after standing idle for some time, use a little kerosene in the oiling places, run the machine rapidly, then wipe clean and oil.

To Avoid Breaking Needles. See that the presser foot or attachments are securely fastened by the thumb screw. Do not sew heavy seams or very thick goods with too fine a needle. A large needle and thread to correspond should be used on heavy work (see inside cover page at back of book).

See that the needle is not bent, and avoid pulling the material when stitching.

Breaking of Needle Thread. If the needle thread breaks it may be caused by:

Improper threading.

Tension being too tight.

The thread being too coarse for size of needle.

The needle being bent, having a blunt point, or being set incorrectly.

Bent thread take-up spring.

Breaking of Bobbin Thread. If the bobbin thread breaks it may be caused by:

Improper threading of bobbin case.

Tension being too tight.

Skipping of Stitches. The needle may not be accurately set into the needle bar or the needle may be blunt or bent. The needle may be too small for the thread in use.

Free Instruction for using the machine is gladly given at any Singer Shop.

Darning or Embroidering

Turn the machine back on its hinges. Unscrew as far as possible the thumb screw (B, Fig. 29) which

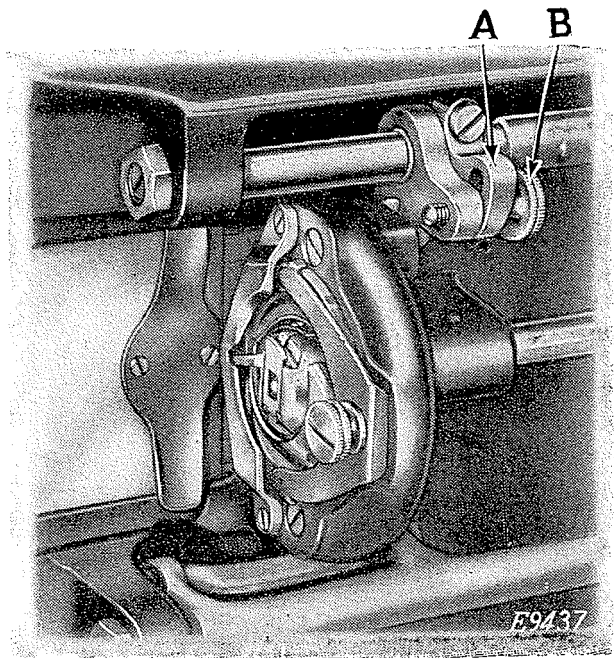

FIG. 29. ADJUSTMENT FOR DARNING OR EMBROIDERING

is located in the lower end of the slot of the feed lifting crank (A, Fig. 29). The feed is thus rendered inoperative and will not interfere with the free movement of the work. Bring the machine forward into place.

Move the stitch regulating lever (B, Fig. 14) to its neutral position in the center of the slot at the front of the machine.

Remove the presser foot and let down the presser bar lifter to restore the tension on the needle thread which is released when the lifter is raised.

Draw up the bobbin thread as instructed on page 16.

Instructions for embroidering are contained in the "Singer Instructions for Art Embroidery," sold by Singer Sewing Machine Co. at a reasonable price.

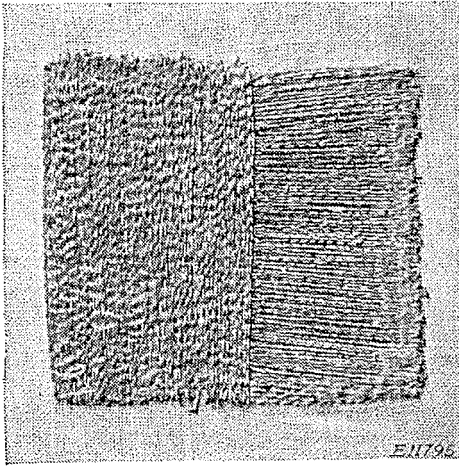

FIG. 30. DARNING IN PROCESS

line of stitches across the hole a little longer than the width of the hole. Continue making parallel lines of stitches across the hole, moving the work backward and forward and at the same time gradually moving the work sidewise until the hole is covered with lines of stitches running across the hole. Then commence as before and move the work lengthwise of the hole until the stitches across the hole are completely covered and the darn is finished.

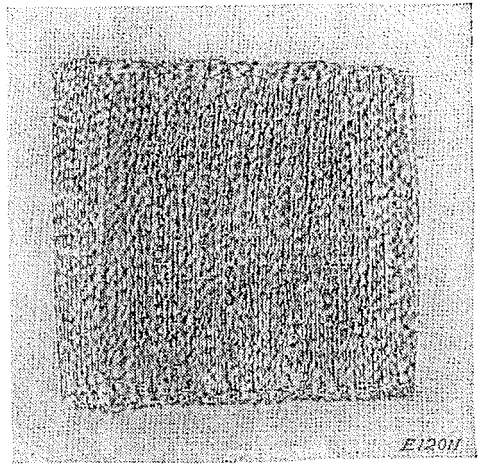

FIG. 31. DARNING FINISHED

When darning flat work, it is advisable to use embroidery hoops to hold the work.

Place the work in the machine, having the unworn part near the hole under the needle. Commence the darning by making a

When you have finished the darning or embroidery, raise the presser bar lifter and replace the presser foot. Turn the machine back on its hinges and move the thumb screw (B, Fig. 29) down to the bottom of the slot of the feed lifting crank (A, Fig. 29) and make sure that the thumb screw is firmly tightened. Bring the machine forward into place, return the stitch regulating lever (B, Fig. 14) to its original position and the machine is ready for regular stitching.

Stockings and socks, underwear, etc., can be more conveniently darned on the machine with the Singer Darner, which can be purchased at any Singer shop or from any Singer salesman.

**Genuine Singer Needles should be used
in Singer Machines.
These Needles and their Containers
are marked with the
Company's Trade Mark "SIMANCO." 1**

**Needles in Containers marked
"For Singer Machines"
are not Singer made needles. 2**

INSTRUCTIONS FOR USING THE ATTACHMENTS

The Foot Hemmer

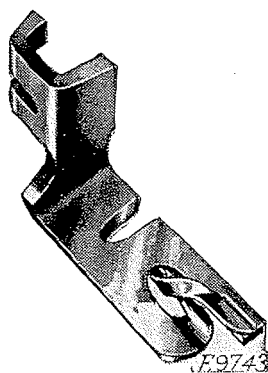

FIG. 32. THE FOOT HEMMER

The Foot Hemmer (Fig. 32) is attached to the machine in place of the presser foot. Raise the needle to the highest position, loosen the thumb screw which clamps the presser foot to the presser bar and remove the presser foot. Attach the Foot Hemmer to the bar, taking care to tighten the screw firmly so that the Hemmer will not become loose when the machine is running. Turn the balance

wheel slowly to make sure that the needle goes through the center of the needle hole and that the lower thread is properly pulled up.

How to Start the Hem at the Very Edge

How to start the hem at the very edge of the material is of great importance in learning to use the Hemmer. If the hem is not started at the edge and the material is pulled bias a perfect hem cannot be made.

There are several ways of starting the hem at the edge, but the most practical one is as follows:

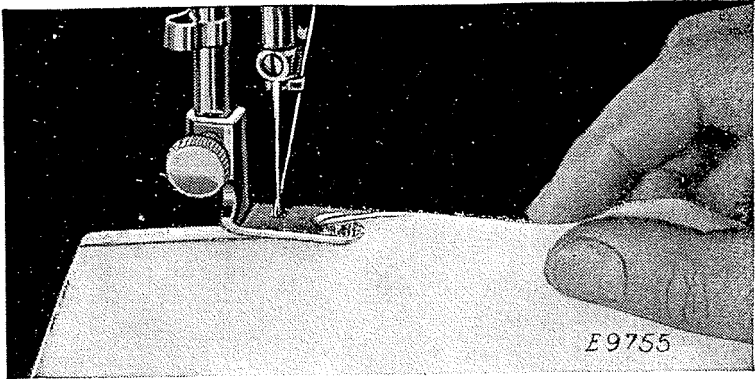

FIG. 33. STARTING A HEM AT THE EDGE

1. Fold over about $\frac{1}{8}$ " of the edge of the material at the starting point for a distance of about one inch.
2. Place the material in the Hemmer at an angle leading to the right at a point just beyond the fold.
3. Draw the material toward you through the Hemmer, as shown in Fig. 33, at the same time making the second fold at the very edge. Continue to draw the material through the Hemmer until the edge is just under the needle. Place the upper and lower threads together under the Hemmer foot and assist in starting of the hem by slightly pulling the threads from the back as the machine is run.

Making a Hem with the Foot Hemmer

The same width of material must be kept in the Hemmer at all times. After placing the correct

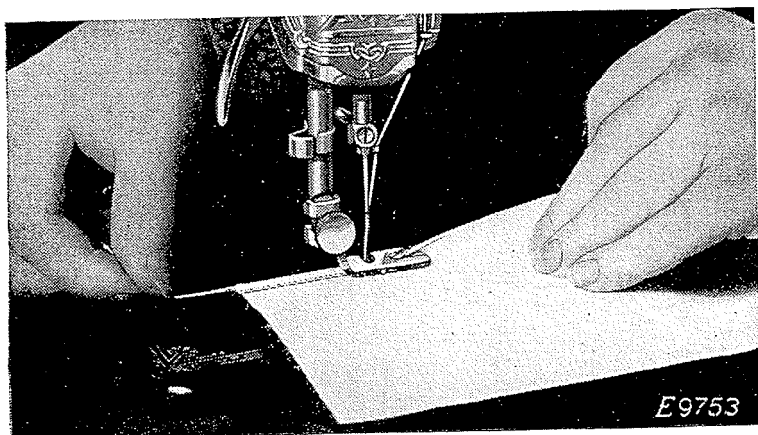

FIG. 34. MAKING A HEM WITH THE FOOT HEMMER

width of material in the Hemmer, hold it in a straight line and you will find it quite easy to make a perfect hem. See Fig. 34.

Making a Hemmed Seam with the Foot Hemmer

The hemmed seam is very practical to use on underwear, or in fact on any garment where a straight seam is used and where a small double seam would be suitable.

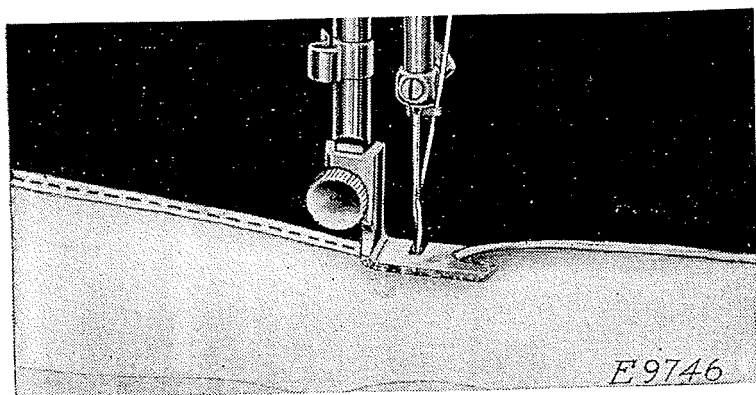

FIG. 35. MAKING A HEMMED SEAM

When using this seam, the garment must first be fitted and the edge of the material trimmed, allowing for about one-eighth inch seam. The two edges are placed together and inserted in the Hemmer in the same manner as a single hem. If the material is bulky, the edge of the upper piece of material may be placed about one-eighth inch in from the edge of the lower piece. See Fig. 35.

The free edge of a hemmed seam may be stitched flat to the garment if desired. First open the work out flat, then place the hem in the scroll of the Hemmer, which acts as a guide, holding the edge of the hem in position while it is being stitched.

If the seam is stitched flat to the garment one row of stitching is visible on the right side.

The hemmed seam may be used on muslin, lawn, percale, organdie or other fine materials where a narrow seam is desirable.

Hemming and Sewing on Lace in One Operation

Start the hem in the regular way and with the needle holding the hem in position, raise the presser

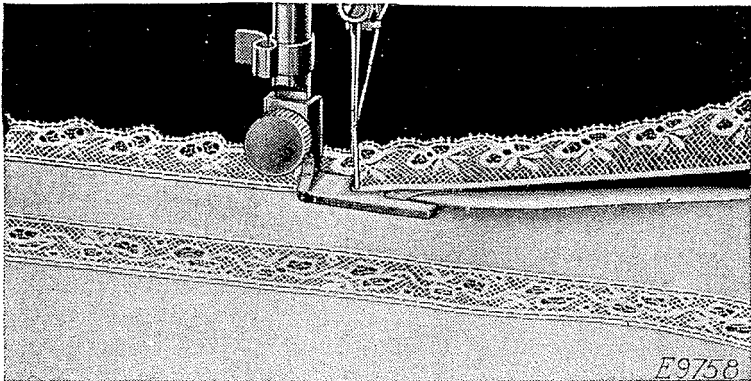

FIG. 36. HEMMING AND SEWING ON LACE

bar sufficiently to allow the edge of the lace to be slipped in under the Foot Hemmer, at the same time bringing it up through the slot at the right of the Hemmer. See Fig. 36. Lower the bar, turn the

balance wheel and catch the edge of the lace with the needle. Guide the hem with the right hand and the lace with the left. Care should be taken not to stretch the lace as it is being fed into the Hemmer.

It is not practical to sew gathered lace on with the Foot Hemmer, as the full lace catches in the Hemmer slot.

A very attractive way of applying lace so that the stitching of the hem is not visible is to start the hem in the regular way, slipping the lace in from the left as you would the second piece of material when making a hemmed seam.

ADJUSTABLE HEMMER—Hemming

Remove the presser foot and attach the adjustable hemmer in its place, as shown in Fig. 37. This

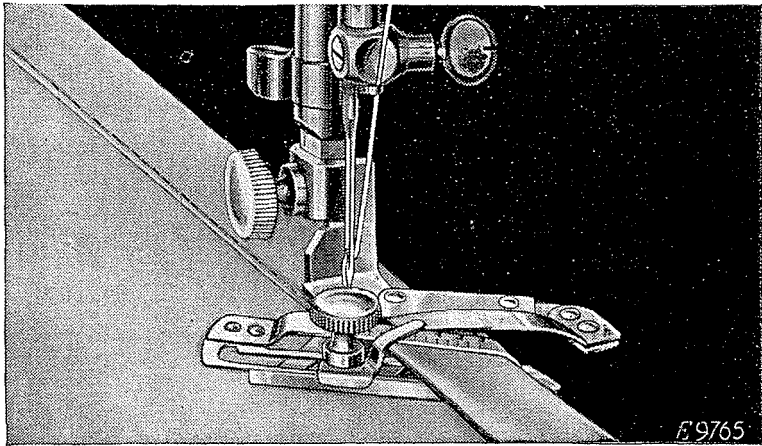

FIG. 37

hemmer will turn hems from $\frac{3}{16}$ inch to $\frac{15}{16}$ inch wide. The adjustment is made by loosening the thumb screw on the Hemmer and moving the scale to the right or left until the hem turned is of the desired width. Place the cloth under the Hemmer and draw the edge toward the left under the scale, as shown

in Fig. 37. Draw the edge of the cloth back and forth until the hem is formed, stopping with the end under the needle. Lower the presser bar and commence to sew, being careful to so guide the cloth as to keep the Hemmer full.

ADJUSTABLE HEMMER—Wide Hemming

To make a hem more than $\frac{15}{16}$ inch wide, loosen the thumb screw in the Hemmer and move the scale

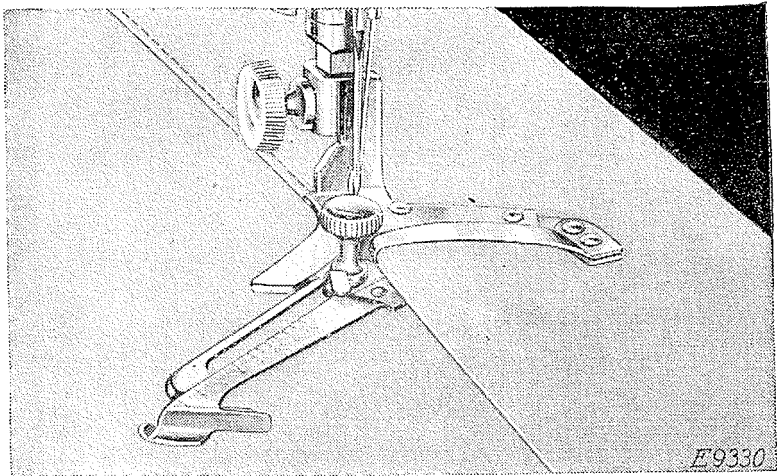

FIG. 38

to the right as far as it will go, then swing it toward you as shown in Fig. 38 and tighten the thumb screw. Fold and crease down a hem of the desired width; pass the fold under the extension at the right of the Hemmer, and the edge into the folder as shown in Fig. 38, and proceed to stitch the hem.

Attaching the Binder to the Machine

Raise the needle to its highest position and remove the presser foot from the machine by loosening the

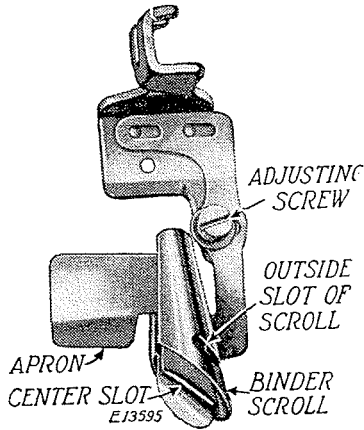

FIG. 39

thumb screw which holds it in place. Compare the foot of the Binder and the presser foot and you will see that they are attached to the machine in the same manner. Attach the Binder to the presser bar. Turn the balance wheel slowly toward you to make sure that the Binder is properly attached to the bar and that the needle goes through the center of the needle hole.

Inserting the Binding in the Binder

Cut the binding to a long point to left, as shown. Insert the pointed end in the binder scroll (Fig. 41) until the pointed end comes through the lower end of the scroll.

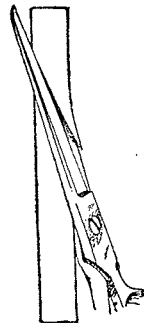

FIG. 40
CUTTING POINT
ON BINDING

Pull the binding through under the presser foot before starting to sew. Note that as the binding passes through the scroll of the Binder the edges are turned in.

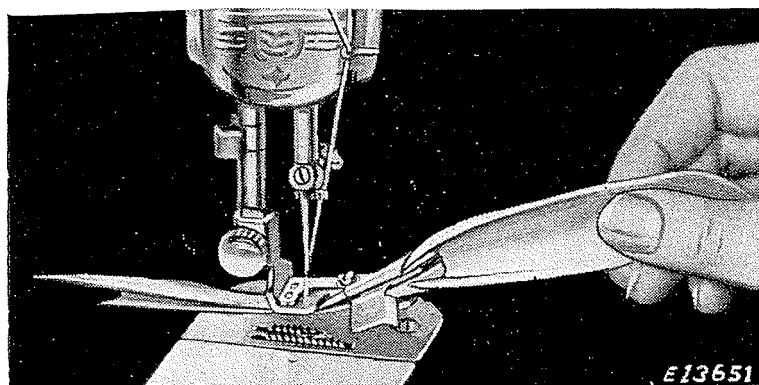

FIG. 41. INSERTING BINDING IN BINDER

Binding May be Purchased Cut and Folded for Use with the Binder

Folded bias binding may be purchased for use with the Binder. The binding comes in a variety of materials and colors. Folded bindings for use with the Binder must measure $\frac{1}{2}$ " in width. The No. 5 width in standard brands usually measures $\frac{1}{2}$ ", but it is always well to be sure of this before purchasing.

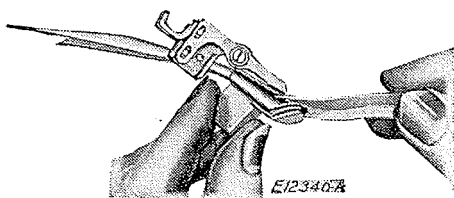

FIG. 42. INSERT FOLDED BINDING IN OUTSIDE SLOT

Folded binding is inserted in the outside slot of the Binder, as shown in Fig. 42. The Binder is adjusted and operated in the same manner as when using unfolded binding. One-half inch braid or ribbon may be used in the same manner.

A binding inserted in the outside slot of the Binder will be turned only once. It is therefore necessary to have finished edges when using binding in this slot.

The Adjustment and Operation of the Binder

The edge to be bound should be held well within the center slot of the scroll (A, Fig. 43). If the

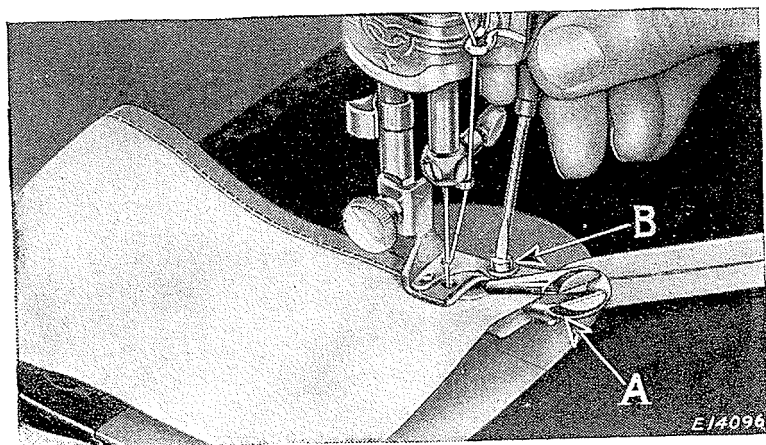

FIG. 43. ADJUSTING THE BINDER

material is allowed to slip away from the scroll when near the needle, the edge will not be caught in the binding. With a little practice it is quite easy to hold the edge in the scroll.

Various materials and conditions require different adjustments of the Binder to bring the stitching close to the edge. A wider adjustment of the Binder is required when binding curves than is necessary when binding a straight edge.

To adjust the Binder for stitching, loosen screw (B, Fig. 43), and move scroll to the right for a narrower adjustment and to the left for a wider adjustment. Care should be taken to see that the screw is well tightened after making an adjustment. To become perfectly familiar with the adjustment of the Binder, practice is necessary.

Binding Outside Curves

Practice is required to bind a curved edge properly. The edge to be bound must be allowed to pass freely

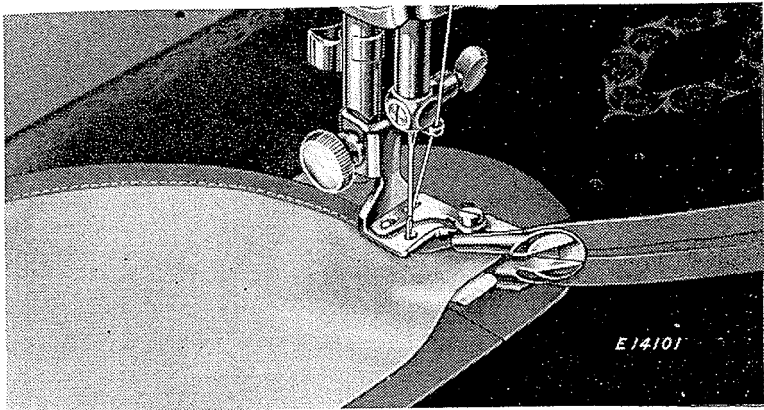

FIG. 44. BINDING AN OUTSIDE CURVE

through the scroll and should not be crowded against the wall of it. Guiding should be from the back

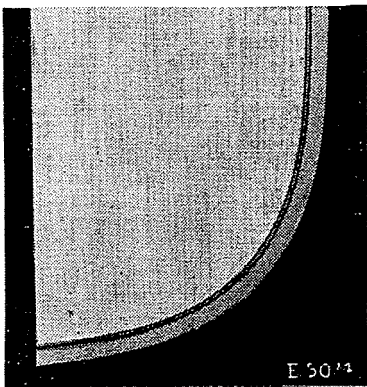

FIG. 45. SAMPLE OF
OUTSIDE CURVE

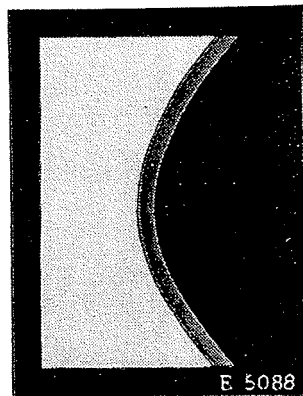

FIG. 46. SAMPLE OF
INSIDE CURVE

of the Binder and to the left, allowing unfinished edges to swing naturally into the scroll of the Binder.

Never pull the binding as it feeds through the Binder, as bias material is very easily stretched and will be too narrow when it reaches the needle. When this occurs the edges will not be turned.

When binding a curved edge (see Fig. 44), turn the material only as fast as the machine sews. It is not possible to hold the material in the entire length of the scroll when binding a small curve.

Do not push the material in too fast, as the edge will then become puckered, and do not stretch the material or the curve will not be the proper shape when finished. If the stitching does not catch the edge of the binding, the scroll should be adjusted a trifle to the left.

Binding Inside Curves

It will be necessary to practice binding an inside curve on various kinds of material, as this curve is found on nearly all garments which may be finished with a bound edge.

When binding an inside curve with the Binder, straighten out the edge as it is being fed into the attachment. When doing this, care should be taken not to stretch the edge of the material.

If the material is soft, like batiste or crepe de chine, add a row of machine stitching close to the edge of the curve before binding.

Applying a French Fold to a Curve

A French fold is applied by placing the material under the attachment and stitching the binding in

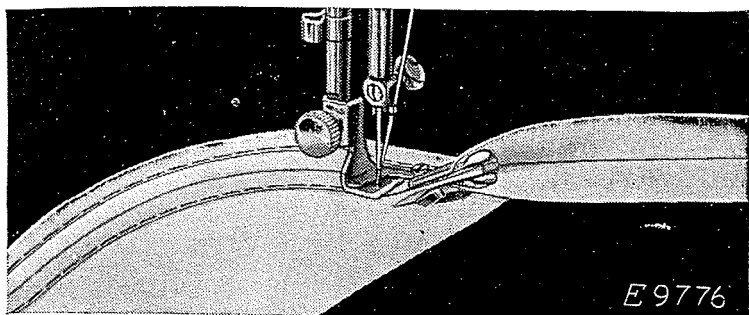

FIG. 47. APPLYING FRENCH FOLDS

position as shown in Fig. 47. A line made by basting or with chalk or pencil may be used as a guide in applying rows where wanted.

THE EDGE STITCHER

This useful attachment is fastened to the machine in place of the presser foot, and will be found an indispensable aid whenever stitching must be kept accurately on the extreme edge of a piece of material. The slots, numbered from 1 to 5 in Fig. 48, serve as guides for sewing together laces, insertions and embroideries, sewing in position hemmed or folded edges, piping or sewing flat braid to a garment.

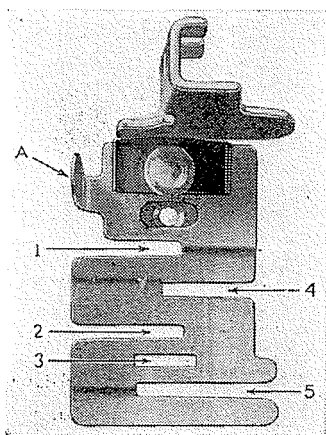

FIG. 48
THE EDGE-STITCHER.

Adjusting the Edge-Stitcher

After attaching the edge-stitcher to the machine, turn the balance wheel slowly by hand to see that the needle goes through the center of the needle hole. The distance of the line of stitching from the edge of the material in the slots can be regulated by pushing the lug (A, Fig. 48) to the right or left. If it moves hard, put a drop of oil under the blue spring, then wipe it dry.

Sewing Lace Together with the Edge-Stitcher

It is difficult to sew two lace edges together even after basting, but the edge-stitcher makes it pos-

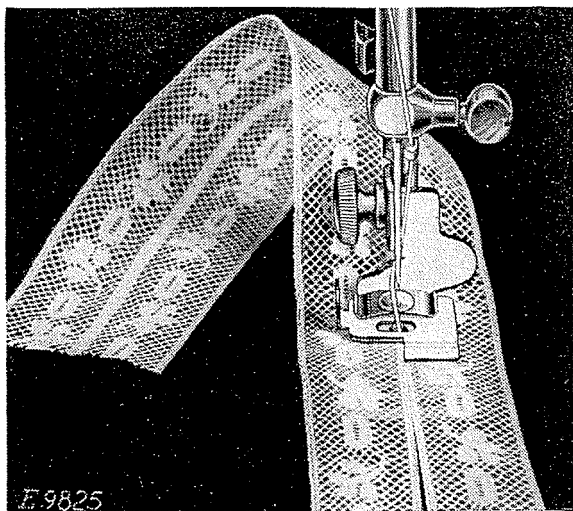

FIG. 49. SEWING LACE TOGETHER

sible to stitch on the very edge. Place one edge in slot 1 and the other in slot 4, and adjust lug (A, Fig. 48) until both edges are caught by the stitching. Hold the two pieces slightly overlapped to keep them against the ends of the slots. The thread tensions should be loose to avoid puckering of fine lace.

Lace and ribbon or other insertions can be set in by using the same slots (1 and 4, Fig. 48). The ma-

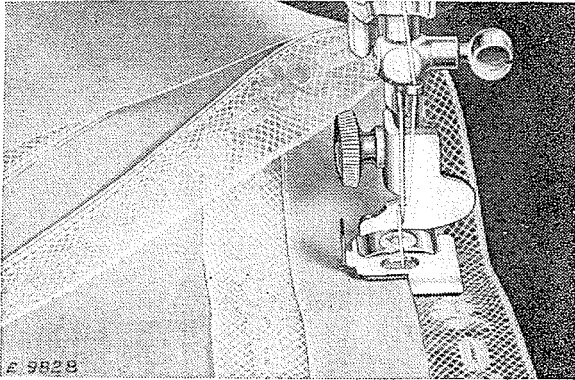

FIG. 50. SETTING IN LACE INSERTION

terial may be folded over before placing it in the slot so that a double thickness is stitched and will not pull out. The surplus material is trimmed away close to the stitching as shown in Fig. 50.

Piping with the Edge-Stitcher

Piping is very attractive if the correct contrasting color is chosen for the piping material. Place the piping, with its finished edge to the left, in slot 3 (Fig. 48). Place the edge to be piped in slot 4, as shown in Fig. 51.

Piping should preferably be cut bias, and should be cut to twice the width of the slot (3, Fig. 48) in the edge-stitcher so that it can be folded once.

Applying Bias Folds with the Edge-Stitcher

Folded bias tape or military braid, used for neat and colorful trimming, may be sewn on by placing the garment under the edge-stitcher the same as under a presser foot, and placing the tape in slot 1 or 4 (Fig. 48). To make a square corner, sew until the turning point is reached, then remove the tape

from the attachment and form the corner by hand, replace it in the slot and continue stitching, as

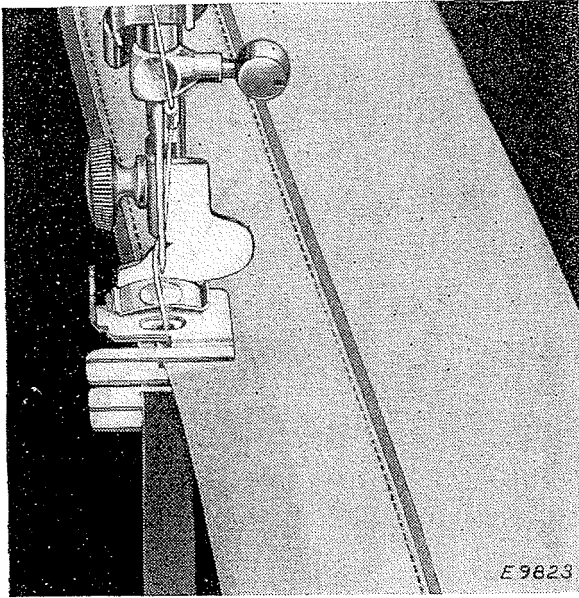

FIG. 51. PIPING WITH THE EDGE-STITCHER

shown in Fig. 52. To space two or more parallel rows, a guide line such as a crease, chalk mark or basting thread should be used.

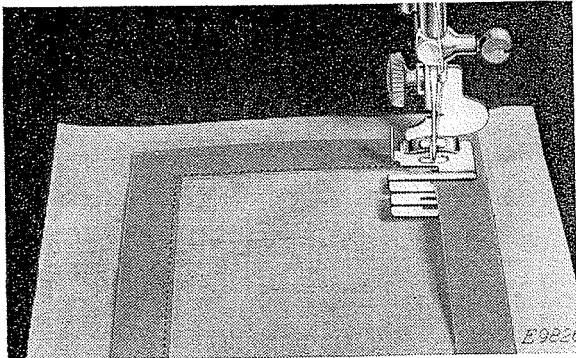

FIG. 52. APPLYING BIAS FOLDS WITH THE EDGE-STITCHER

Stitching a Wide Hem with the Edge-Stitcher

A wide hem on sheets, pillow slips, etc., may be stitched evenly with the edge-stitcher after the hem

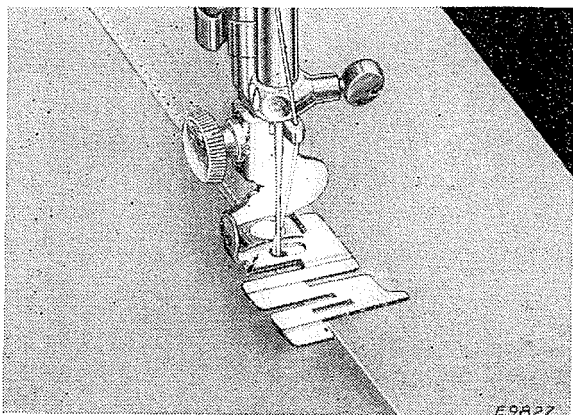

FIG. 53. MAKING A WIDE HEM

has been measured and the edge turned. Insert the edge in slot 5 as shown in Fig. 53 and adjust to stitch as close to the edge as desired.

Making a French Seam

An even French seam may be made by inserting the two edges to be joined, wrong sides together, in slot 1 or 2 and stitching close to the edge; then folding both right sides together and inserting the back of the seam into slot 1 again and stitching with just enough margin to conceal the raw edges. See Fig. 54.

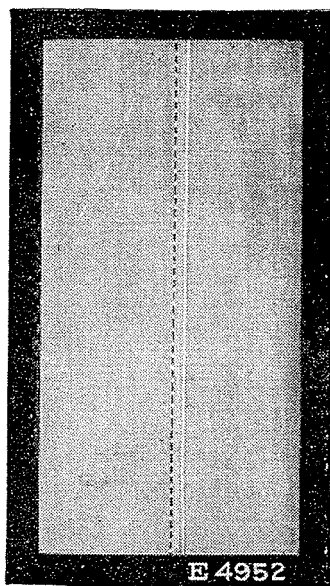

FIG. 54. A FRENCH SEAM

Tucking with the Edge-Stitcher

Dainty narrow tucking may be produced on the edge-stitcher by inserting creased folds in slot 1 as

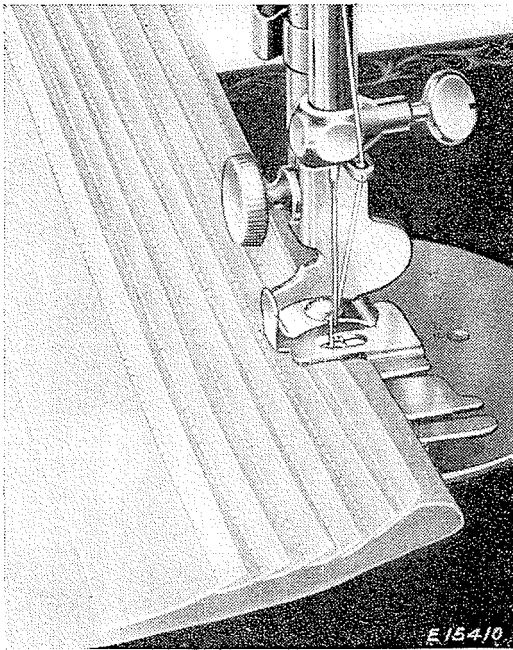

FIG. 55. TUCKING WITH THE EDGE-STITCHER

shown in Fig. 55, and adjusting the edge-stitcher to right or left for the desired width of tuck, up to $\frac{1}{8}$ inch. Successive tucks may be easily creased by folding the material at the desired distance from the previous tuck, and then running the length of the fold over a straight edge such as the edge of the sewing machine cabinet. The secret of good tucking lies in a light tension, short stitch, and fine thread and needle.

SHIRRING WITH THE GATHERER

The gatherer is fastened to the machine in the same manner as the presser foot. Material placed under the gatherer and stitched in the usual way will be slightly gathered. Any fabric that drapes well is especially suited for shirring with the gatherer. Most shirring with the gatherer is done with a long stitch and tight tension. To increase the fullness of the gathers, lengthen the stitch. To decrease the fullness, shorten the stitch.

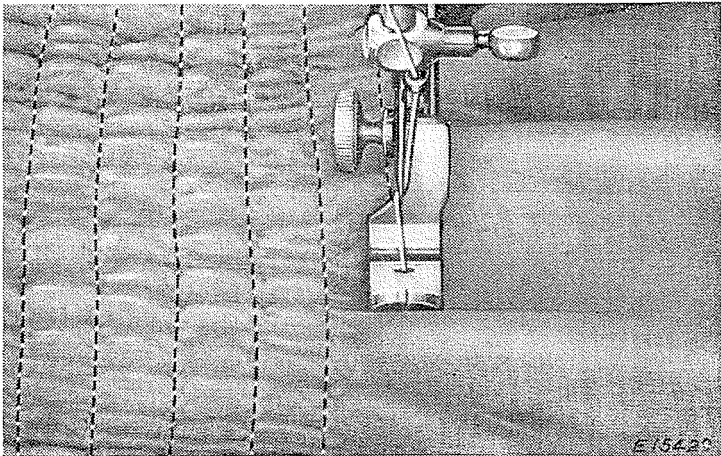

FIG. 56. THE GATHERER IN OPERATION

With the gatherer, it is possible to shirr in narrow rows as shown in Fig. 56. The material may be guided as easily as when sewing with the presser foot. Fine materials, such as batiste, silk or net, may be very attractively shirred. Where only a slight fullness is required, as at the top of a sleeve or around the neck, the gatherer will be found very convenient.

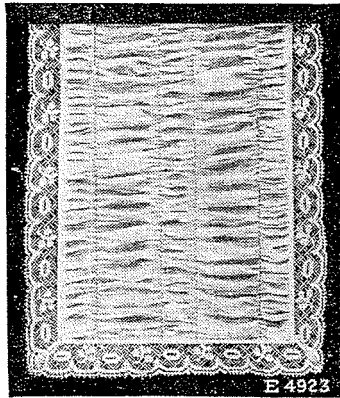

FIG. 57. SHIRRING

A very pleasing effect may be gained by using thread or embroidery silk of contrasting color on the bobbin. Fig. 58 shows a white organdie collar and cuff set with red and green smocking made with the gatherer, using fine crochet cotton or tatting thread on the top and white cotton on the bobbin.

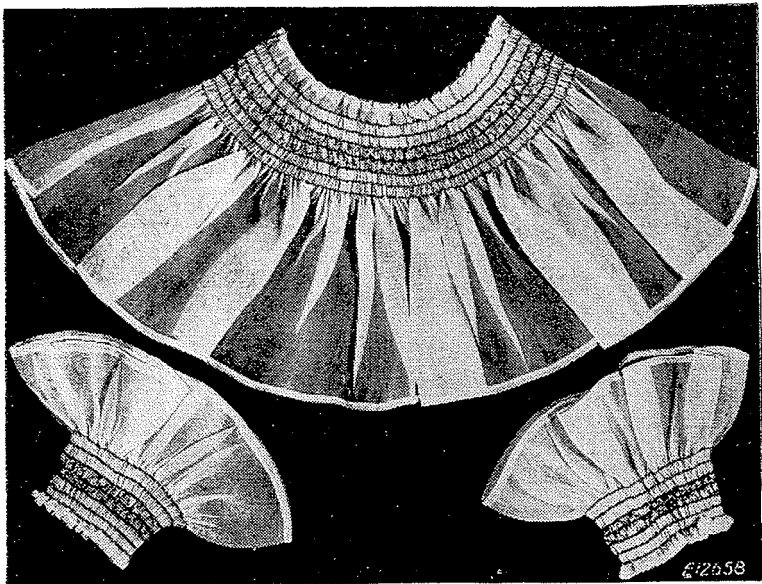

FIG. 58. SMOCKING

RUFFLER

Lines 1, 2, 3, 4 and 5 shown in Fig. 59 indicate where the material is to be placed for various operations as follows:

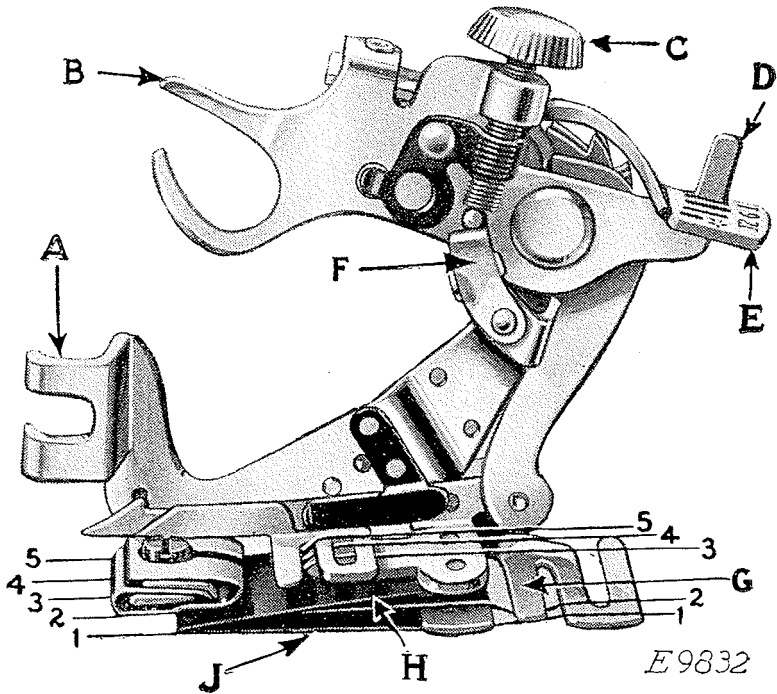

FIG. 59. THE RUFFLER AND ITS PARTS

- Line 1**—the correct position for the material to which the ruffled material is applied.
Line 2—material to be ruffled.
Line 3—the facing for the ruffle.
Line 4—the strip of piping material.
Line 5—the edge to be piped.

Refer to Fig. 59 when inserting the material in the ruffler.

The names and uses of the principal parts of the ruffler are as follows:

(SEE REFERENCES IN FIG. 59)

- A**—**FOOT**—the part by which the ruffler is attached to the presser bar.
- B**—**FORK ARM**—the section that must be placed astride the needle clamp.
- C**—**ADJUSTING SCREW**—the screw that regulates the fullness of the gather.
- D**—**PROJECTION**—the part that projects through the slots in the adjusting lever.
- E**—**ADJUSTING LEVER**—the lever that sets the ruffler for gathering or for making a plait once at every six stitches, or once at every twelve stitches, as desired; also for disengaging the ruffler, when either plaiting or gathering is not desired.
- F**—**ADJUSTING FINGER**—the part which regulates the width or size of the plaits.
- G**—**SEPARATOR GUIDE**—the guide on the underside of the ruffler, containing slots into which the edge of the material is placed to keep the heading of the ruffle even; also for separating the material to be ruffled from the material to which the ruffle is to be attached.
- H**—**RUFFLING BLADE**—the upper blue steel blade with the teeth at the end to push the material in plaits up to the needle.
- J**—**SEPARATOR BLADE**—the lower blue steel blade without teeth, which prevents the teeth of the ruffling blade coming into contact with the feed of the machine, or the material to which ruffle or plaiting is to be applied.

To Attach the Ruffler to the Machine

Raise the needle bar to its highest position and remove the presser foot. Attach the ruffler foot (A, Fig. 59) to the presser bar by means of the thumb screw, at the same time placing the fork arm (B, Fig. 59) astride the needle clamp as shown in Fig. 60.

To Adjust the Ruffler for Gathering

The adjusting finger (F, Fig. 60) is not intended for gathering and should be moved forward or away from the needle, as shown in Fig. 60.

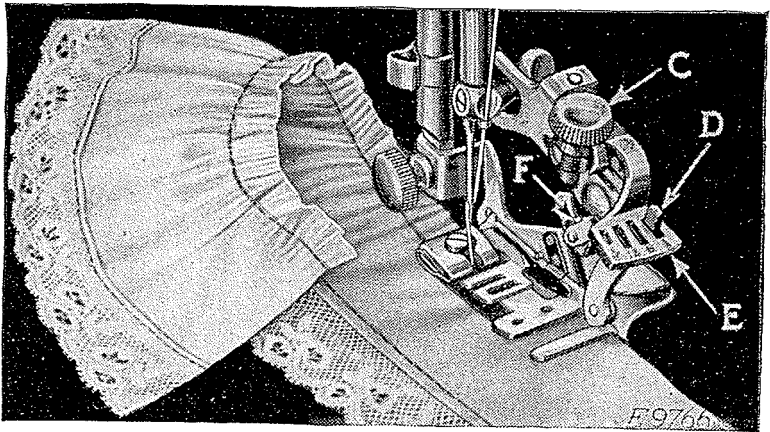

FIG. 60

Raise the adjusting lever (E, Fig. 60) and move it to the left so that the projection (D, Fig. 60) will enter the slot marked "1" in the adjusting lever (E) when the lever is released. The ruffling blade will then move forward and back once at every stitch. Insert the material to be ruffled between the two blue blades, following the line 2 in Fig. 59. Draw the material slightly back of the needle, lower the presser bar and commence to sew.

To make fine gathering, shorten the stroke of the ruffling blade by turning the adjusting screw (C, Fig. 60) upward; also shorten the stitch. To make full gathering, lengthen the stroke of the ruffling blade by turning the adjusting screw (C) downward; also lengthen the stitch. By varying these adjustments, many pleasing varieties of work can be accomplished.

To Make a Ruffle and Sew it to a Garment in One Operation

Insert the material to be ruffled between the two blue blades, as shown in Fig. 61, following the line

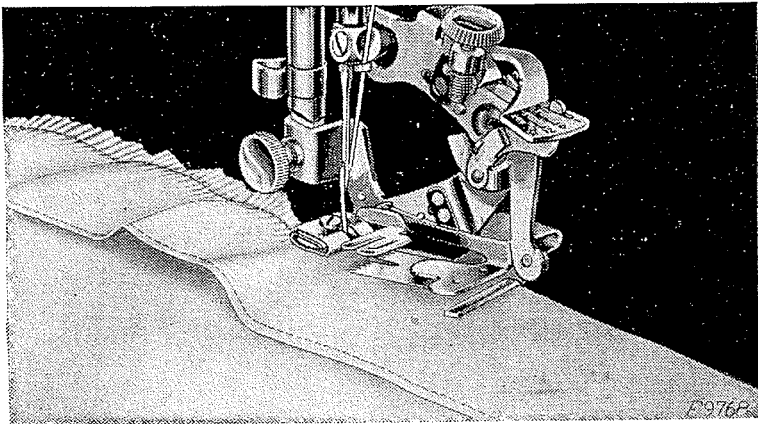

FIG. 61

2, in Fig. 59. Place the garment to which the ruffle is to be attached, under the separator blade, following the line 1, in Fig. 59. Proceed the same as for gathering.

The edge of the ruffled seam can be bound by using the binder.

To Ruffle and Sew on a Facing in One Operation

Insert the material to be ruffled between the two blue blades, following the line 2 in Fig. 59. Place the garment to which the ruffle is to be attached, under the separator blade, following the line 1, in Fig. 59. Place the material for the facing over the upper blue blade, as shown in Fig. 62, following the line 3, in Fig. 59. The facing may be straight or bias material. If the facing is to be on the right side of the garment, place the garment and

the ruffle so that the wrong sides are together. If the facing is to be on the wrong side, place the right sides of the garment and the ruffle together.

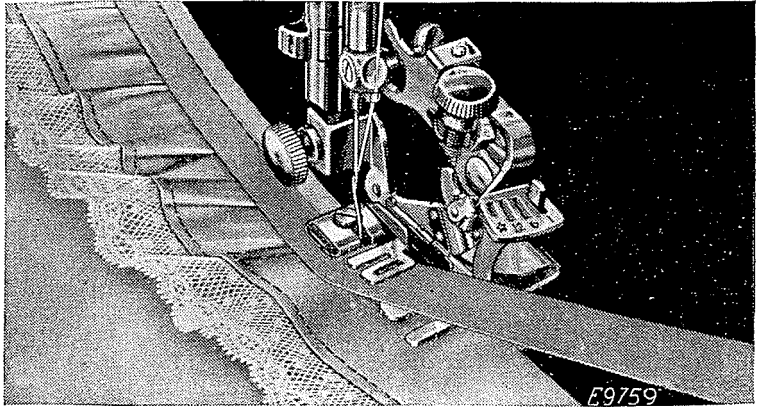

FIG. 62

Piping a Ruffle

Insert the material to be ruffled between the two blue blades, following the line 2, in Fig. 59. This

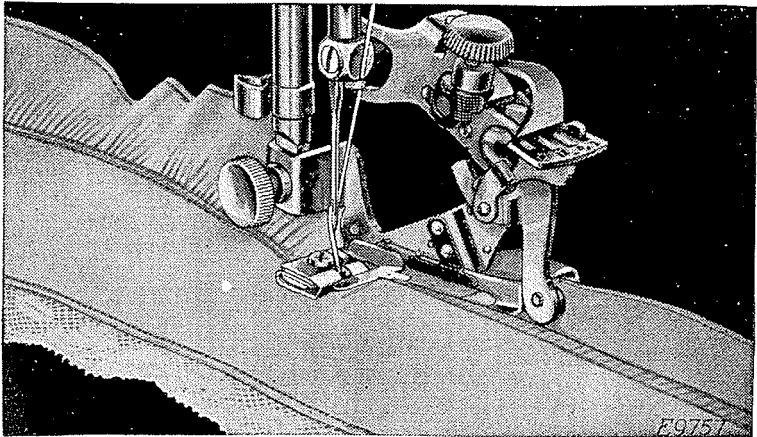

FIG. 63

material must not be over $1\frac{1}{4}$ inches wide, as it is carried through the ruffler with the finished

edge of the ruffle to the right of the attachment as shown in Fig. 63.

The material for piping must measure about $\frac{1}{4}$ inch wide when folded in the center and is usually cut on the bias. Place the piping material in the ruffler, following the line 4, in Fig. 59, with the folded edge of the piping to the right. The material to which the piping and ruffling are to be sewn should be folded on the edge and inserted in the ruffler, following the line 5, in Fig. 59.

To Adjust the Ruffler for Plaiting

Raise the adjusting lever (E, Fig. 64) and move it to the right so that the projection (D, Fig. 64)

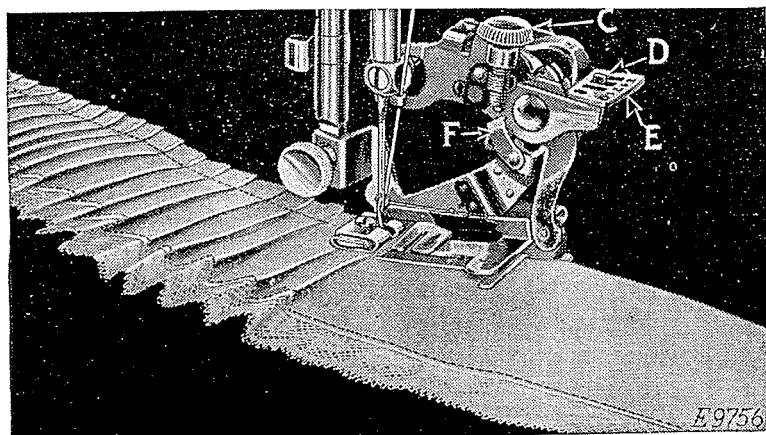

FIG. 64

will enter the slot marked "6" in the adjusting lever when the lever is released. The ruffling blade will then move forward and back once at every six stitches. To adjust the ruffling blade to make a plait once at every twelve stitches, place the adjusting lever (E, Fig. 64) so that the projection (D) enters the slot marked "12" in the adjusting lever. Insert the material to be plaited between the two blue blades, following the line (2, Fig. 59). The size or width of plaits is regulated by the adjusting screw

(C, Fig. 64) and the adjusting finger (F, Fig. 64). To make a wider plait, move the adjusting finger (F) back or toward the needle and turn the adjusting screw (C) downward. To make a smaller plait, turn the adjusting screw (C) upward. The distance between plaits is regulated by the length of stitch.

To Adjust the Ruffler for Group Plaiting and Gathering

The ruffler can be adjusted for group plaiting by lifting the adjusting lever (E, Fig. 65) and moving

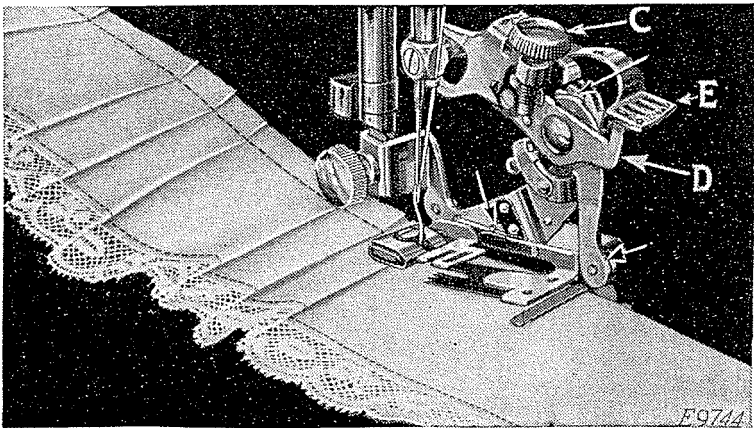

FIG. 65

it to the right so that the top of the projection (D, Fig. 65) enters the small slot indicated by the star on the adjusting lever. This should be done at the points where you wish to make the space between the plaits. The ruffler will then stop and plain stitching will be made. When the desired space has been made, adjust the lever (E) so that the projection (D) enters either the slot marked "6" or the slot marked "12." By alternately making groups of plaits and plain spaces, as shown in Fig. 65, very attractive work can be produced.

To Oil the Ruffler

Occasionally apply a drop of oil to the working parts of the ruffler at each of the places indicated by the unlettered arrows in Fig. 65. After oiling, operate the ruffler on a waste piece of material to prevent the oil soiling the work. If the ruffler does not plait evenly, a drop of oil may remedy the trouble.

Genuine Singer Needles should be used
in Singer Machines.
These Needles and their Containers
are marked with the
Company's Trade Mark "SIMANCO." 1

Needles in Containers marked
"For Singer Machines"
are not Singer made needles. 2

The Singer Universal Threader and
Seam Ripper
Makes Threading Easy

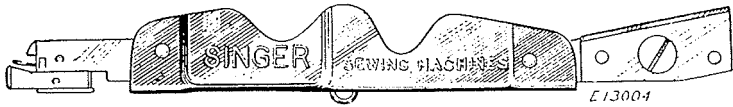

This useful little accessory enables you to thread a hand sewing needle or a machine needle without eye-strain. As shown on the following page, it also serves

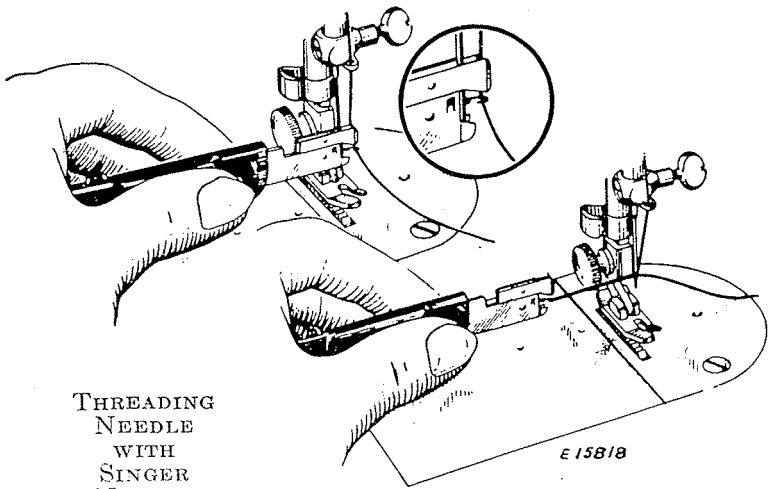

THREADING
NEEDLE
WITH
SINGER
NEEDLE
THREADER

as a seam ripper with a blade set at just the right angle for quickly picking out stitches. Both ends fold into the handle like a jack-knife. It is sold by all Singer Shops at a reasonable price.

The Singer Material Gripper

Taking out stitches is no longer a tedious job when you use the Singer Seam Ripper and Material Gripper,

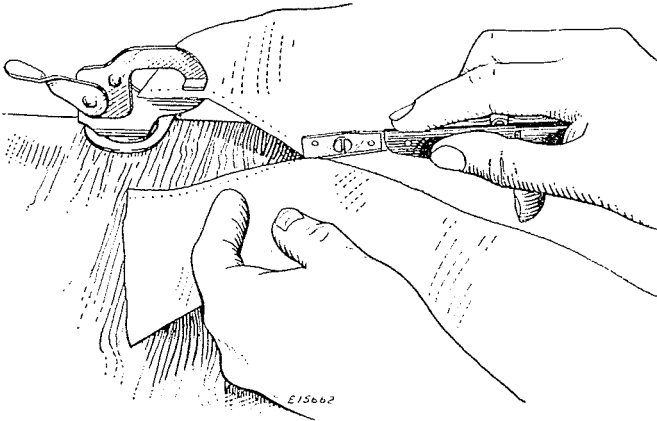

OPENING SEAM WITH
SINGER SEAM RIPPER

MATERIAL GRIPPER HOLDS CLOTH

as shown above. The gripper acts as a third hand, holding your material while you pin, sew or rip. It is sold by all Singer Shops at a reasonable price.

RELATIVE SIZES OF NEEDLES AND THREAD

(Class and Variety of Needles Used, 15x1)

SIZES OF NEEDLES	CLASSES OF WORK	SIZES OF COTTON, SILK OR LINEN THREAD
9	Georgette, chiffon, net, light weight synthetic fabrics, fine dimity, lawn, batiste, and other featherweight or sheer fabrics. For infants' clothes and for dainty lingerie; also fine lace and all delicate or gossamer fabrics.	100 to 150 Cotton OO & OOO Silk Twist
11	All medium, light weight summertime fabrics. For children's clothes, dainty washable dresses and aprons, glass curtains.	80 to 100 Cotton O Silk Twist
14	Light weight woolens, firm dress silks and cottons, draperies and fabric furnishings. For smocks and men's fine shirts. For general household sewing; for fine quilting.	60 to 80 Cotton A & B Silk Twist
16	Heavy cretonne, madras, muslin, damasks and quilts. For stitching aprons and men's work shirts.	40 to 60 Cotton C Silk Twist
18	Heavy weaves of coating, canvas, bed ticking, awnings, porch furniture covers, boys' duck suits, work or sports uniforms.	30 to 40 Cotton D Silk Twist
19	Suiting, ticking, sacking, tarpaulin, duck, drilling. For wash uniforms and bedding supplies for hospitals and hotels.	24 to 30 Cotton E Silk Twist 60 to 80 Linen
21	Bags, Coarse Cloths and Heavy Goods.	40 to 60 Linen or very Coarse Cotton

When sending orders for needles be sure to specify the size required.



This Trade Mark
is on the Arm of Every
Singer Sewing Machine