

SINGER



SLANT-O-MATIC

401A

T H E S I N G E R C O M P A N Y

Instructions for using

SINGER*

SLANT-O-MATIC*

401*

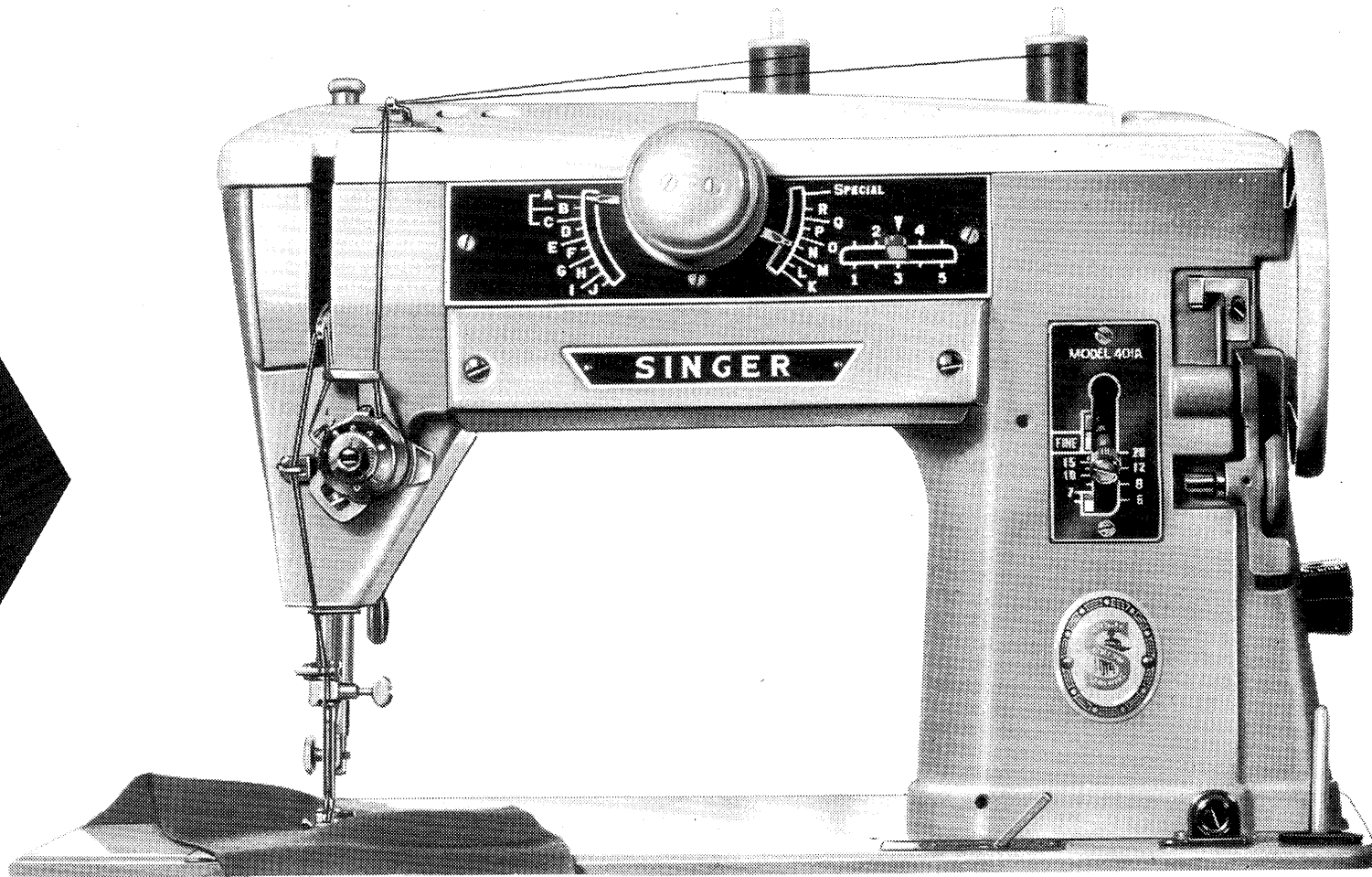

The *SLANT-O-MATIC* – the greatest sewing machine ever built!

*A Trademark of THE SINGER COMPANY

**The SINGER *SLANT-O-MATIC*
the greatest sewing machine ever built . . .**

From the moment you see the new *SLANT-O-MATIC*, you'll know it's excitingly *different*. You'll marvel at its automatic sewing . . . its almost unbelievable ease of operation . . . the remarkable services it performs. You'll delight in its sure, beautiful stitching. The only automatic zigzag machine for home use made entirely in America, it out-sews all other machines in both straight and fancy stitching.

● *World's first* automatic with a slant needle and gear drive. Seeing is easier, sewing smoothest ever. No slipping or stalling.

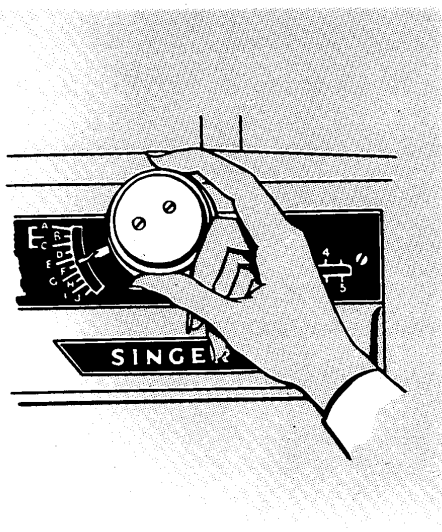

- *World's first* automatic with double easy threading. Has built-in threading chart, handy "drop-in" bobbin in *front* of needle!
- *World's first* automatic with a built-in eye-level stitch chart, that lets you "tune" the knob for whatever fancy stitch you want!

Add to these major developments in sewing machine design the following **ADVANCED** features, and you have a machine far ahead in design, unequalled in performance.

- **ELEVATOR TYPE** multi-purpose calibrated throat plate, lever operated, simplifies darning.
- **HINGED** face plate swings open for easy cleaning.
- **SUPERFINE CONTROL** of stitch length ensures perfect satin stitching.
- **PERFECT** Straight Stitching.
- **BUILT-IN LIGHT** focused on sewing area.
- **NEW NEEDLE CLAMP** holds one or two regular needles—same or different sizes for exciting twin needle stitching.
- **ALL MECHANISM** completely enclosed.
- **NEW ADJUSTABLE HINGED** zipper and cording foot.
- **NEW SPECIAL PURPOSE FOOT.**
- **NEW SEAM GUIDE.**

TO GET THE MOST ENJOYMENT FROM YOUR SINGER

Take advantage of the free sewing lessons to which you are entitled! Skilled, SINGER-trained teachers will give you personal guidance and assist you in learning the fundamentals of home sewing.



SINGER SERVICE

Wherever you go you will find expert, dependable SINGER* Service close at hand. SINGER is interested in helping you keep your SINGER Sewing Machine in top running condition. That is why you should always call your SINGER CENTER if your machine ever requires adjustment or repair. Only from your SINGER CENTER can you obtain the services of a trained SINGER repair man and warranted SINGER* parts.



EVERYTHING FOR THE WOMAN WHO SEWS

The answer to your sewing needs is at your SINGER CENTER. There you will find a wide choice of sewing aids, notions, sewing instructions and services. Look for the famous red "S" and SINGER trademarks on your SINGER CENTER and the ever ready SINGER Service Car. See phone book under THE SINGER COMPANY for address nearest you.

FABRIC, THREAD, NEEDLE AND STITCH LENGTH CHART

TYPES OF FABRICS	THREAD SIZES	NEEDLE SIZES	MACHINE STITCH SETTINGS FOR STRAIGHT SEWING	
			INSIDE SEAMS	TOP STITCHING
Filmy materials comparable to Net, Marquisette, Chiffon, Silk and Chiffon Velvets, Voiles, Ninon	50 Embroidery 100 Cotton Synthetic Thread	9	15 to 20	15 to 20
Sheer materials comparable to Lawn, Dimity, Synthetic Sheers, Paper Taffetas, Pure Silks, Gossamer Silks, Silk or Synthetic Tricots, Synthetic Velvets, Satins	50 Embroidery 80 to 100 Cotton Synthetic Thread	11	12 to 15	15 to 20
Lightweight materials comparable to Gingham, Chambray, Pique, Poplin, Percalé, Cretonne, Chintz, Faille, Bengaline, Wool Flannel, Wool Jersey, Wool Crepe, Cotton Velvets and Velveteens, Lightweight Suitings	50 Mercerized 60 to 80 Cotton A Silk	14 or 16	12	15 to 18
Medium heavy materials comparable to Corduroy, Crash, Gabardine, Rep, Heavy Suitings and Coatings	Heavy Duty Mer. 40 to 60 Cotton Synthetic Thread	16	10	12
Heavy materials comparable to Sailcloth, Denim, Ticking, Overcoatings	30 to 40 Cotton Thread	18	8	10
Plastic Materials	50 Embroidery Synthetic Thread 50 Mercerized	11 or 14	10	12

When ordering needles, always specify "Class and Variety 15 x 1" and state the size and quantity required.

NEEDLES AND THREAD

This machine uses a 15 x 1 needle.
Sizes 9, 11, 14, 16 and 18.

For perfect stitching, select correct needle and thread to correspond with fabric according to table on **page 5**. Be sure to use like threads for both needle and bobbin.

NEEDLE INSERTION

Raise the needle bar to highest point by turning the hand wheel toward you. Loosen the needle clamp screw. Insert needle upward into clamp as far as it will go, with the flat side of the needle to the back and the **long groove toward you**. Tighten needle clamp screw.

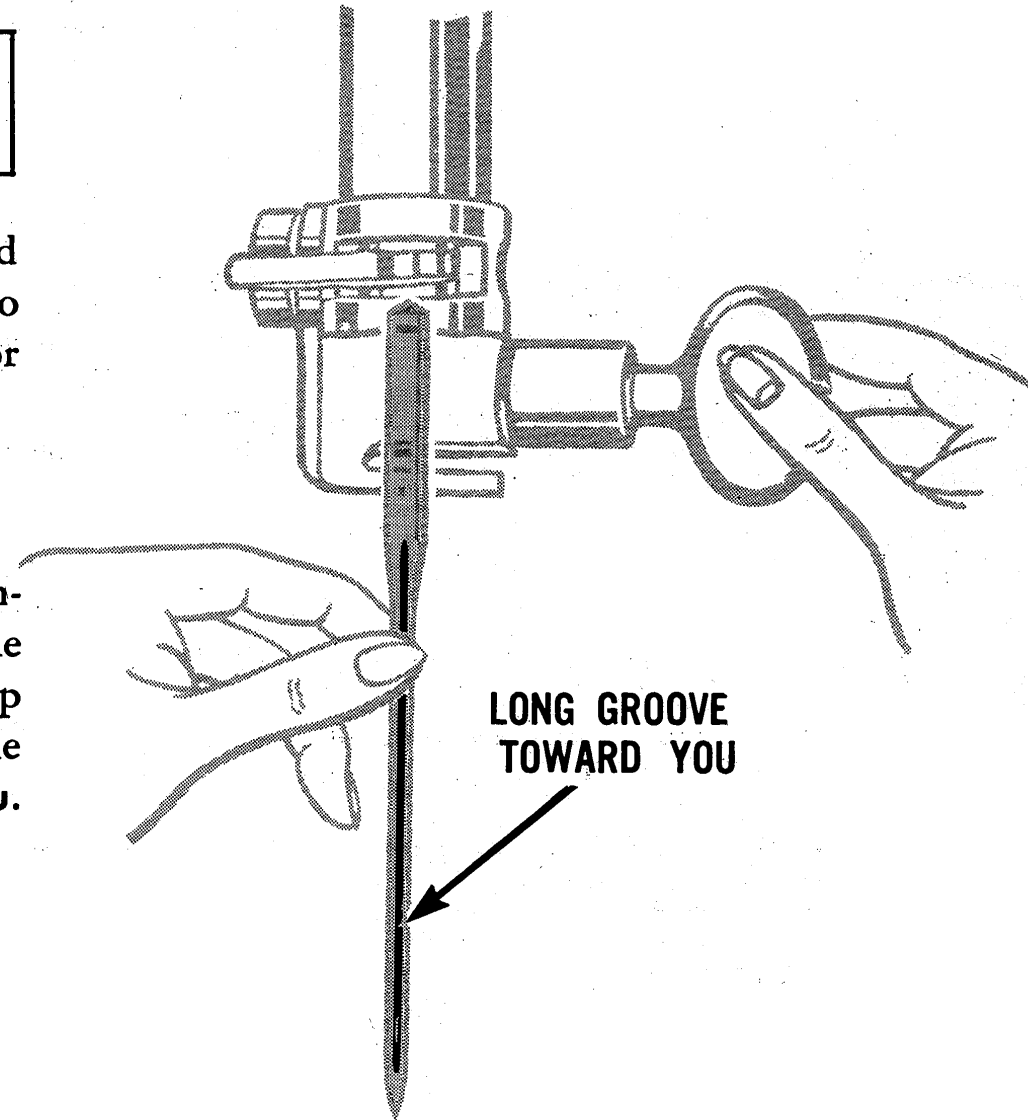

UPPER THREADING—SINGLE NEEDLE

Raise take-up lever to highest point. Place thread on spool pin and lead through threading points shown. Thread needle from front to back. Draw sufficient thread through eye of needle with which to start sewing.

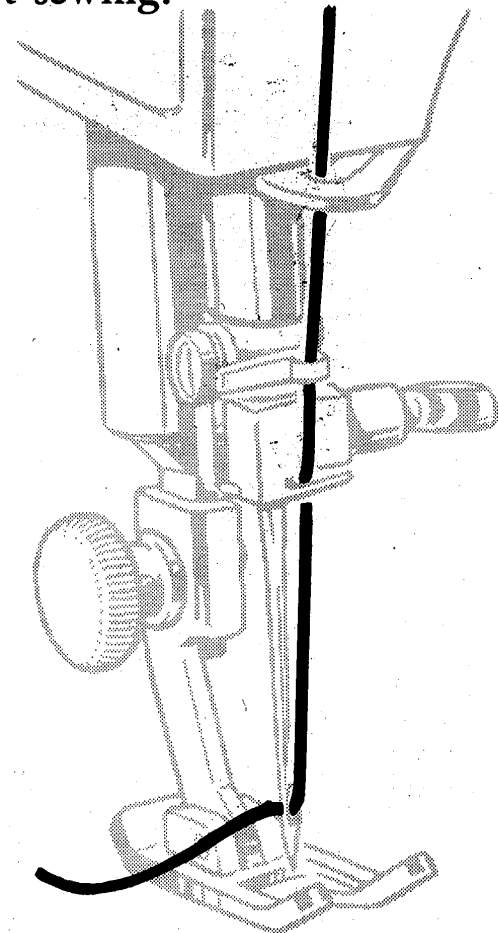
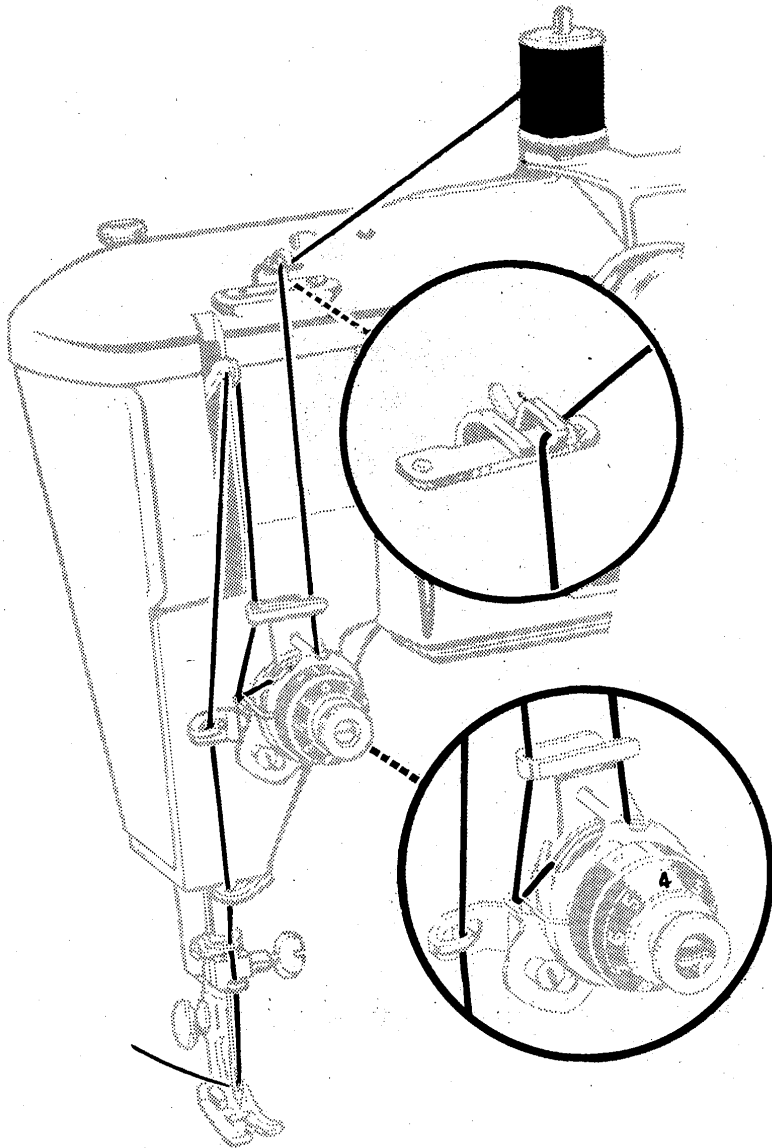

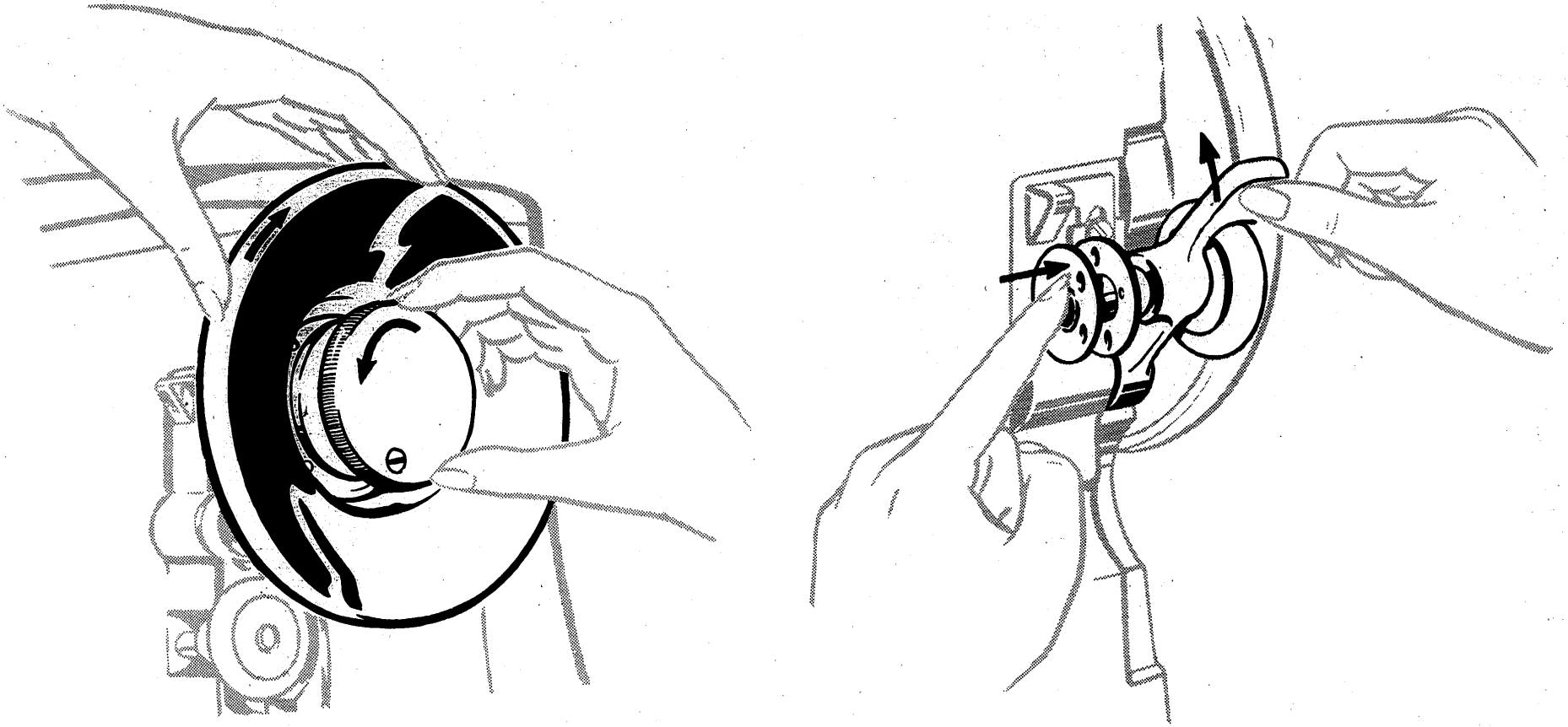
WIND THE BOBBIN

Loosen stop motion screw with right hand. Raise bobbin winder and position bobbin on spindle. Press winder against hand wheel.

WIND THE BOBBIN (Cont'd.)

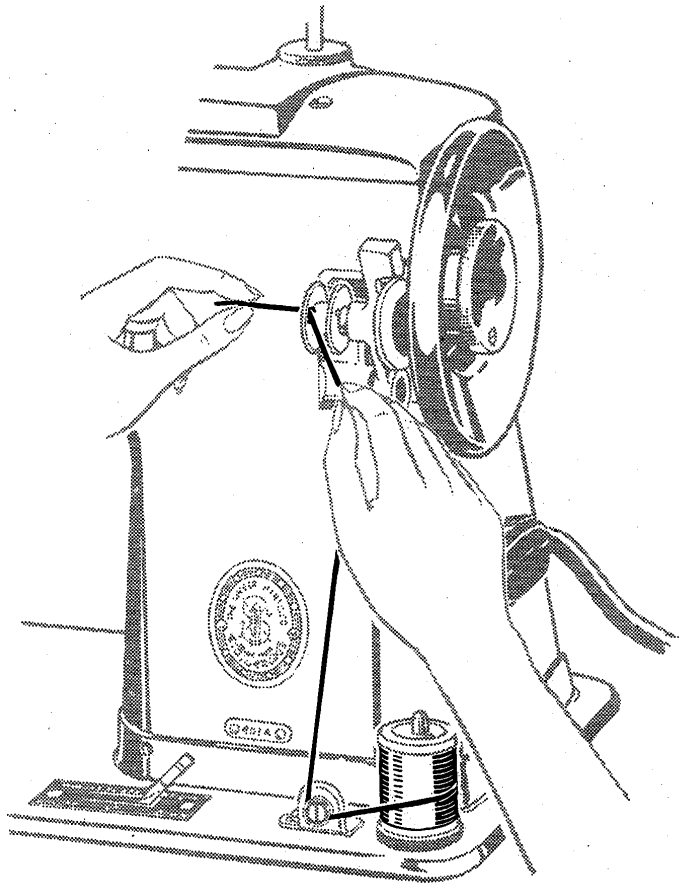

Place thread on spool pin and lead between bobbin winder tension discs. Thread through hole in left side of bobbin as shown.

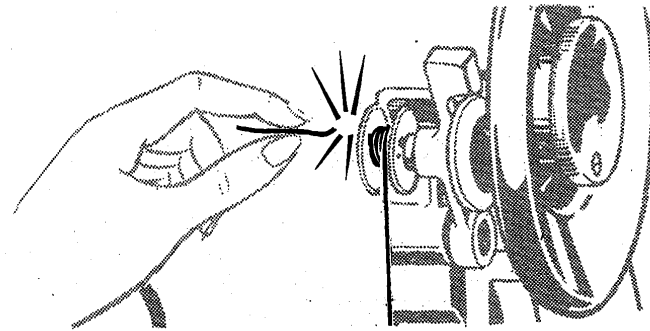

Hold thread end to start winding. Activate machine.

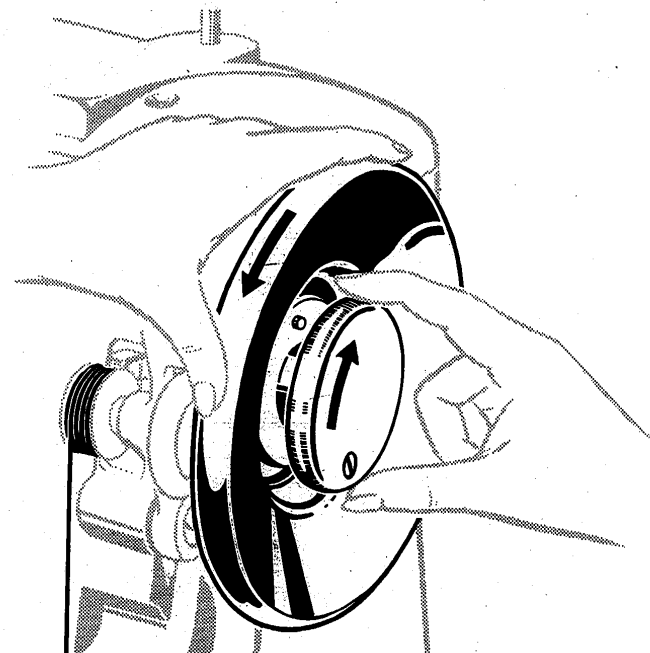

Full bobbin will automatically release. Tighten stop motion screw.

REMOVE THE BOBBIN

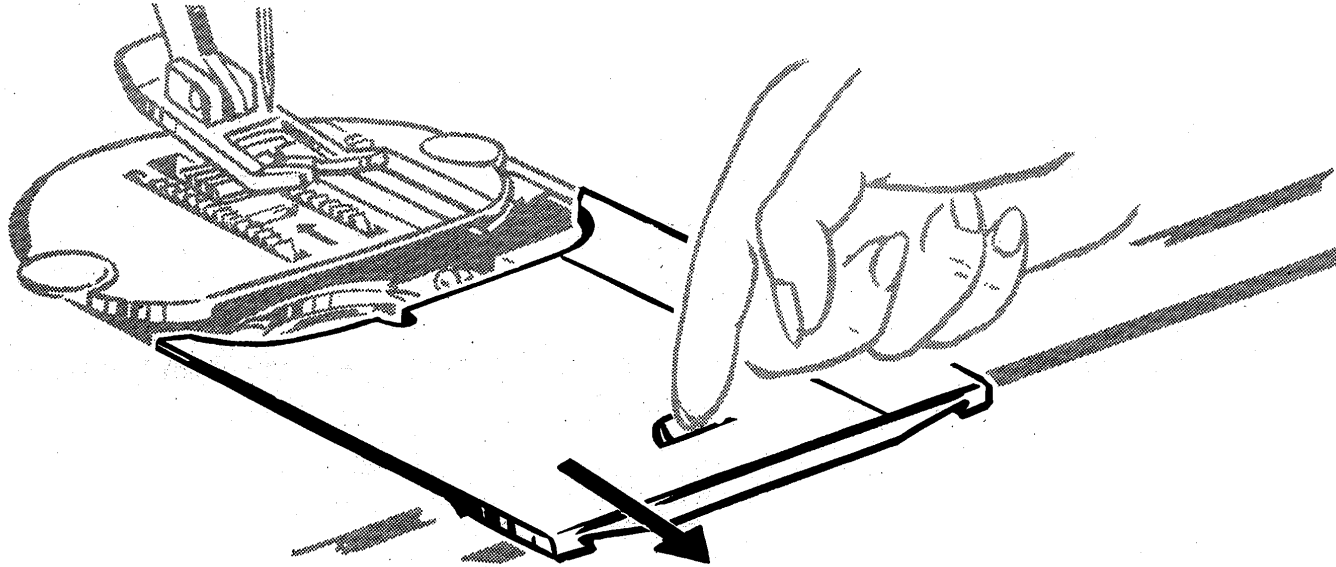

Open slide plate and remove bobbin.

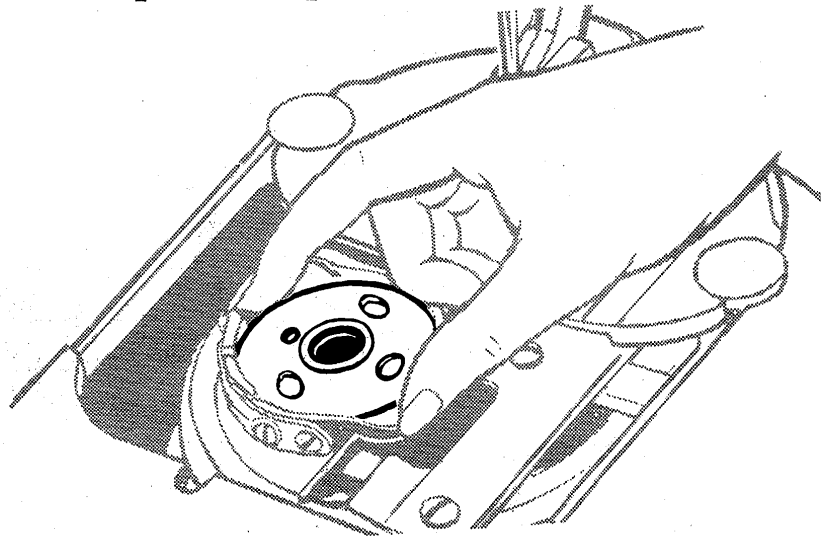

THREADING THE BOBBIN CASE

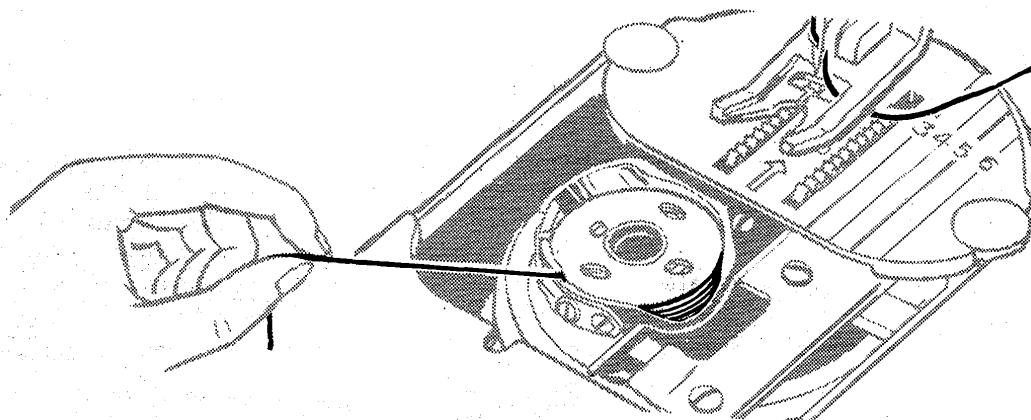
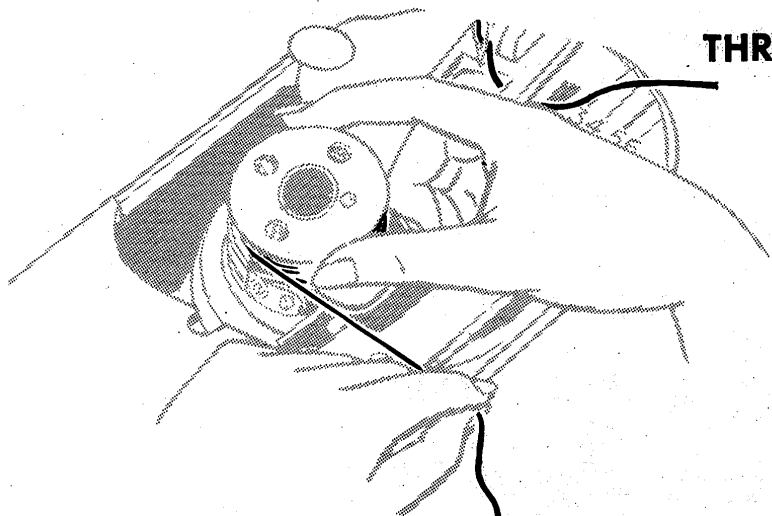

Hold bobbin so that thread leads off, in direction shown. Place bobbin in case. Lead thread into slot and under spring.

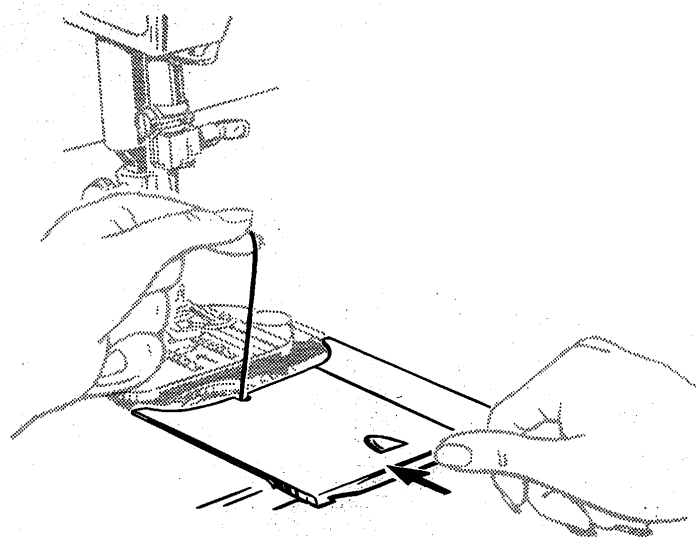
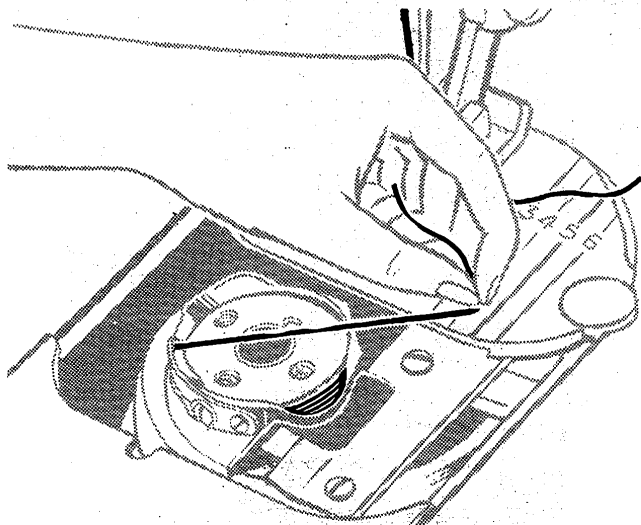

Draw thread into notch at end of spring, pulling off about 3 inches of thread across the bobbin.

Close slide plate allowing thread to enter notch.

PRINCIPAL PARTS OF MACHINE 401

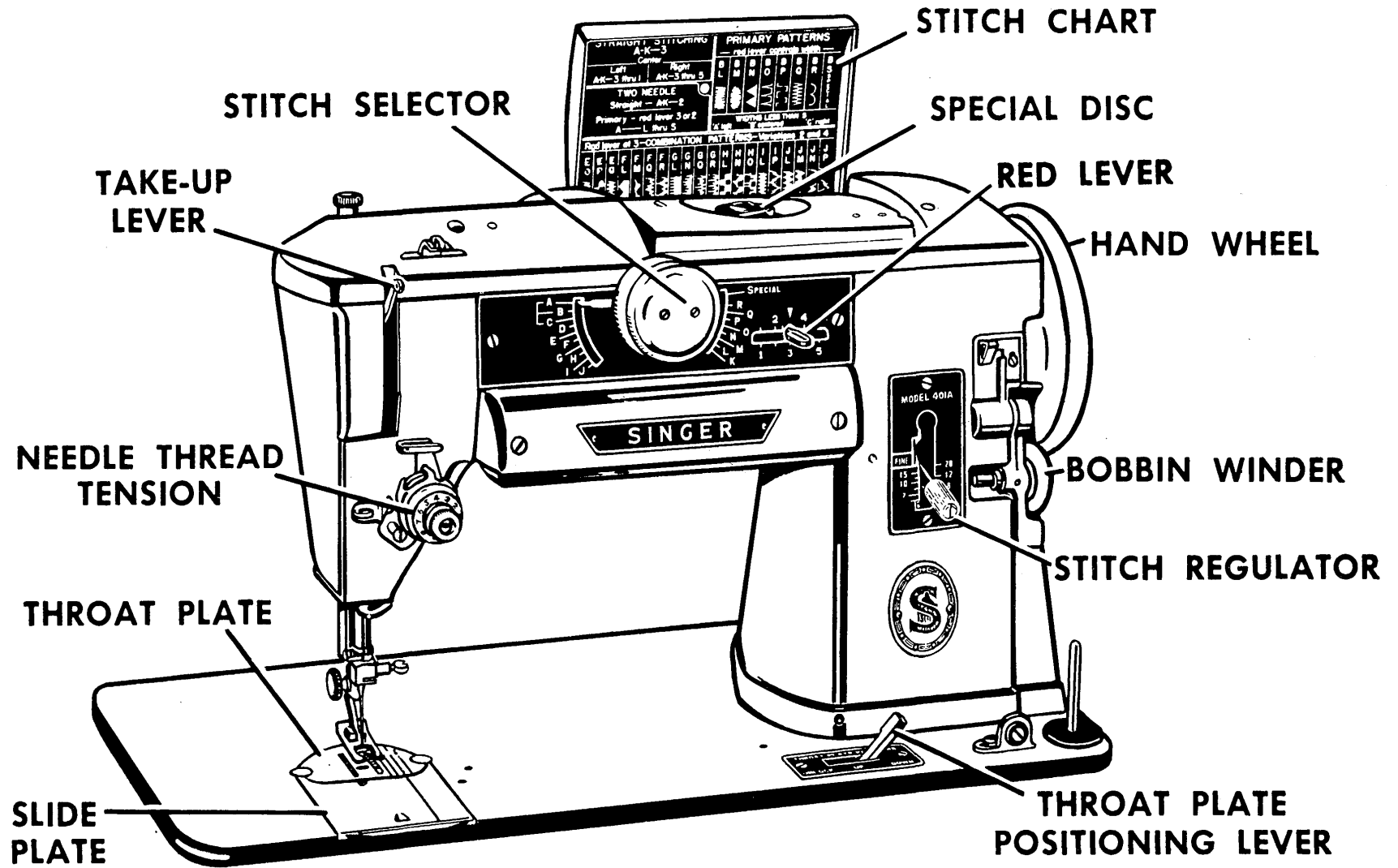

STITCH LENGTH REGULATOR

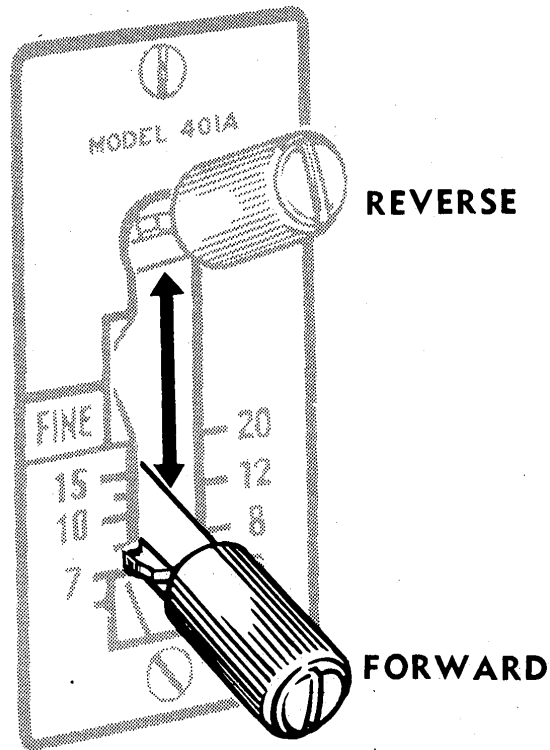

TO RELEASE

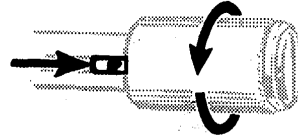

TO TIGHTEN

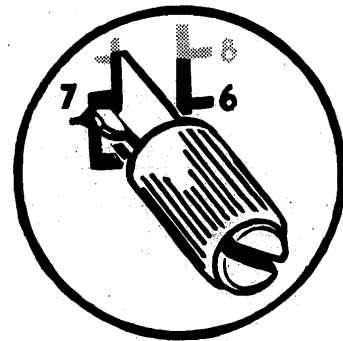
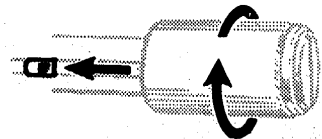

LOCKED
SETTING

Numerals on the indicator represent the number of stitches per inch.

The upper indented area of the indicator represents "fine" stitch lengths above 20.

The lower indented area of the indicator allows the #6 stitch length setting to be "locked" in place when stitching folds, pleats or multiple layers of heavy fabric.

To set stitch length: Release pointer by turning thumb nut to the left, as shown. Position lever for desired stitch length. Tighten pointer against the plate by turning thumb nut to the right.

Once the pointer has been positioned, reverse stitching is accomplished by raising the lever to its highest point. The #6 "locked" position cannot be reversed.

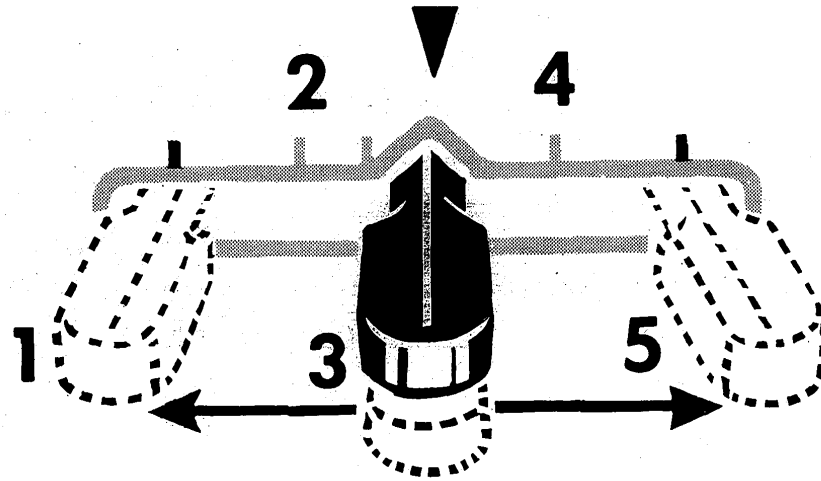
RED LEVER

A Red Lever setting is necessary for both straight and zigzag stitching. Numerals indicate five positions, but intermediate settings may also be used. To position, depress lever and slide it left or right to desired setting.

STITCH SELECTOR

Set Red Lever at 3

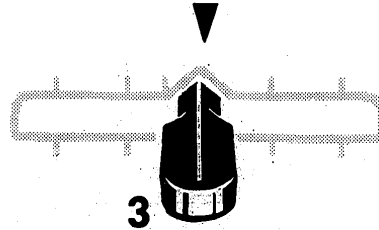

All settings on the left of the plate are controlled by the outer knob. Push (using right hand)—select desired setting and release. All settings on the right of the plate are controlled by the inner knob. Pull (using left hand)—select desired setting and release. Do not make selector adjustments while the needle is in the fabric.

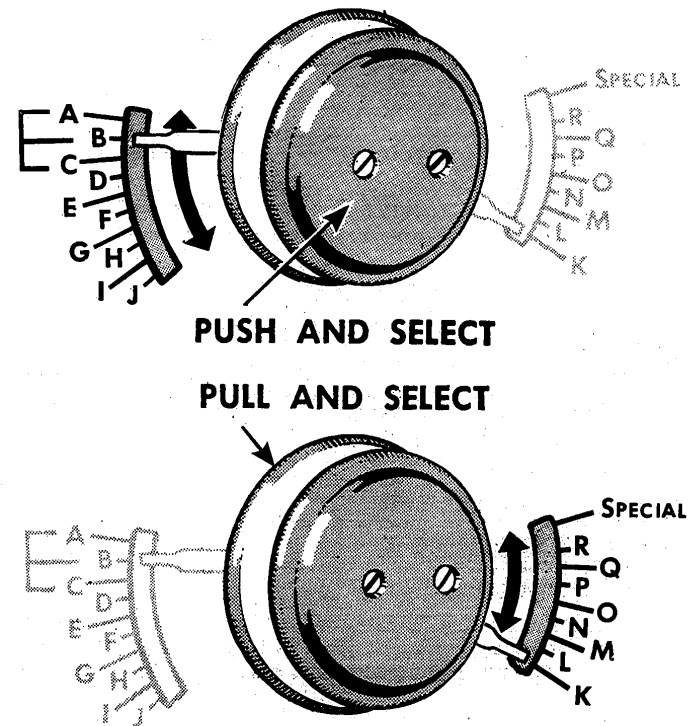
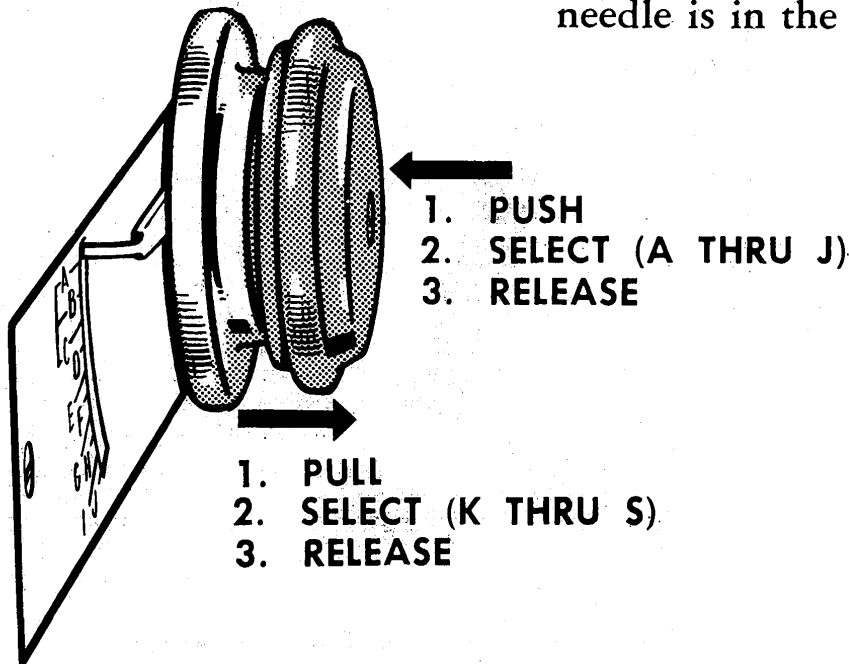

THROAT PLATE POSITIONS

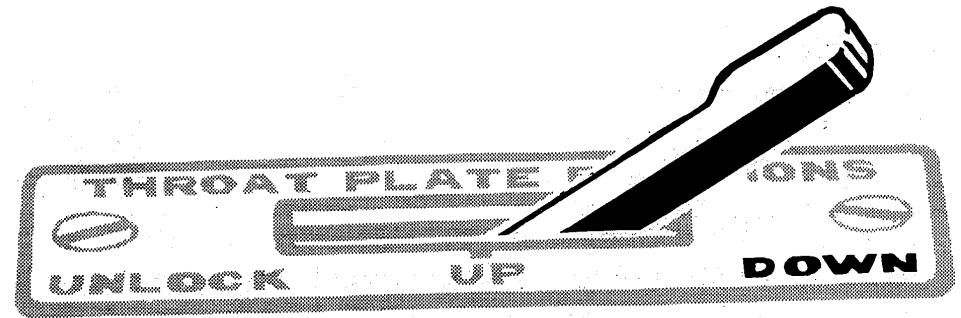
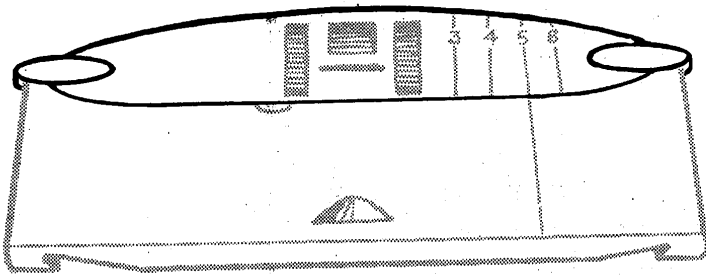

Throat plate in "Down" position for general sewing.

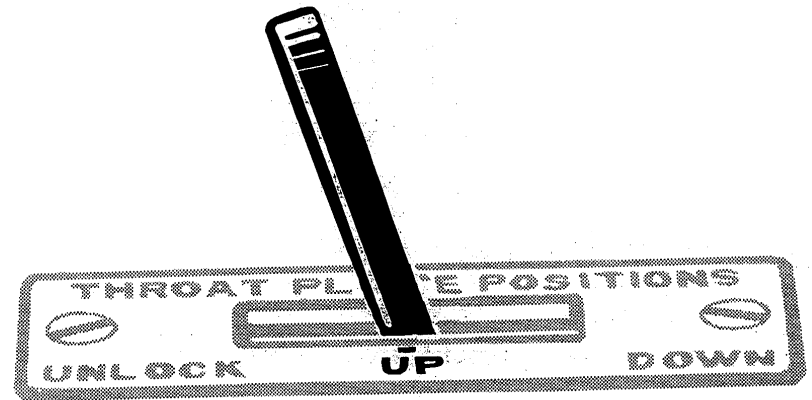
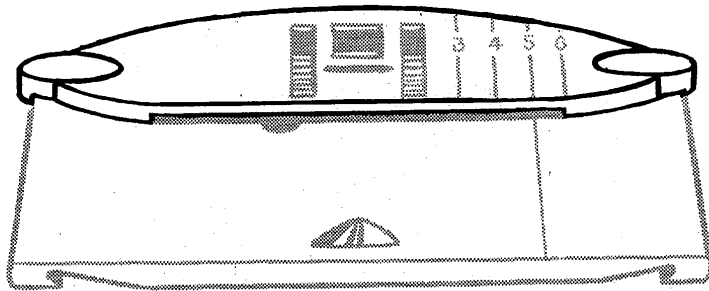

Throat plate in "Up" position for darning, embroidering and button sewing.

THROAT PLATE

REMOVAL AND REPLACEMENT

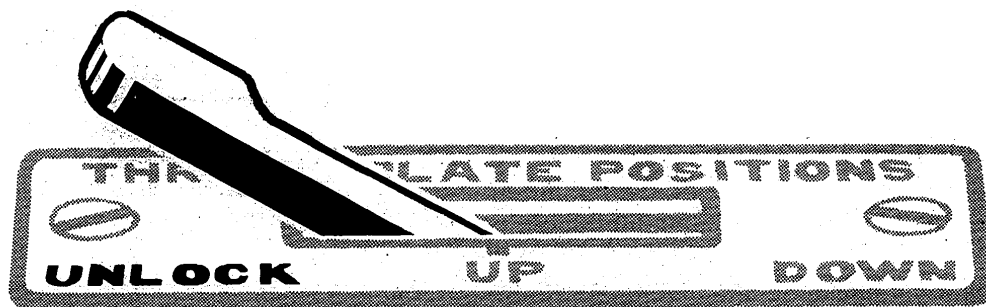
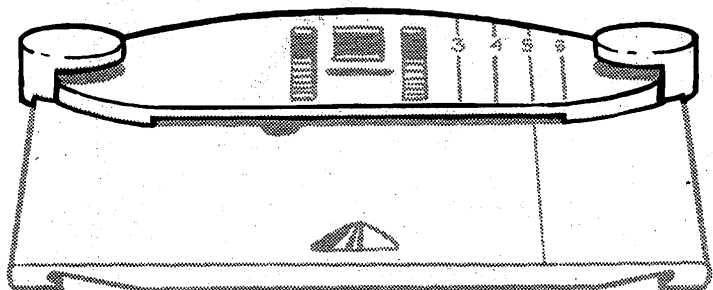

Throat plate in "Unlock" position for removal and replacement.

**TAKE-UP LEVER
MUST BE IN
LOWEST POSITION**

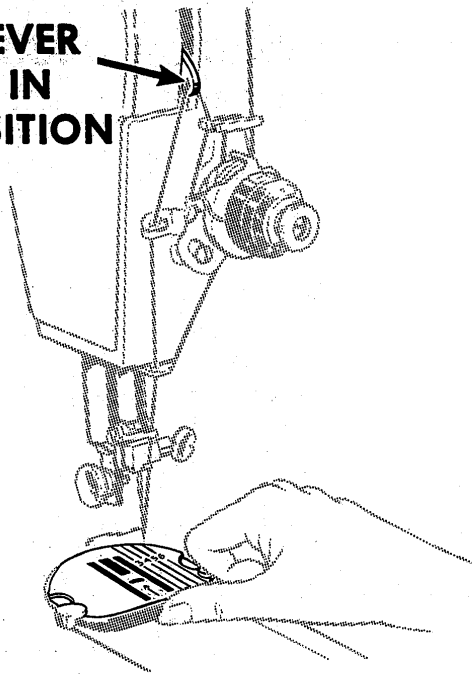

Raise presser bar. Turn hand wheel to drop take-up lever to its lowest point. Set throat plate lever to "Unlock" position. This preparation applies to both removal and replacement.

Remove throat plate by sliding it back.

Replace throat plate by sliding it on from the rear.

Lock in position.

Presser foot need not be removed for this operation.

STRAIGHT STITCHING A K 3

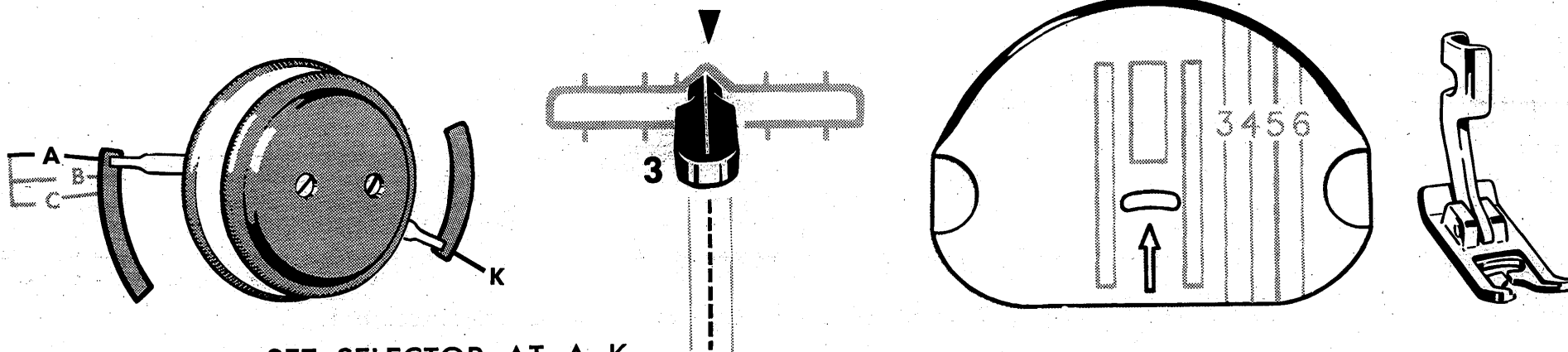

SET SELECTOR AT A K.
RED LEVER AT 3—TO LOCATE STITCHING IN CENTRAL POSITION.
GENERAL PURPOSE THROAT PLATE AND PRESSER FOOT.

Use general purpose throat plate and presser foot for all utility sewing, long straight seams, etc., and where there is occasion to alternate between straight and zigzag stitching.

STRAIGHT STITCH THROAT PLATE AND PRESSER FOOT

Use the straight stitch throat plate and presser foot where fabric and sewing procedure require close control . . . for precision stitching of curved and scalloped edges, top stitching, edge stitching, etc.

For best results, this equipment should be used when stitching sheer and filmy fabrics, knits and tricot (particularly synthetics) and all soft spongy materials.

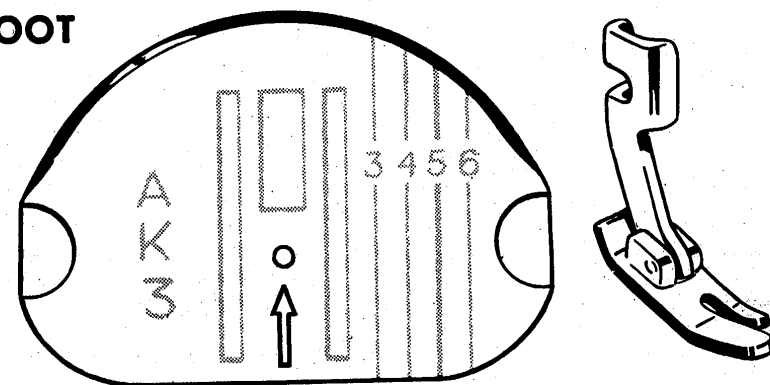

STRAIGHT STITCHING SECONDARY POSITIONS

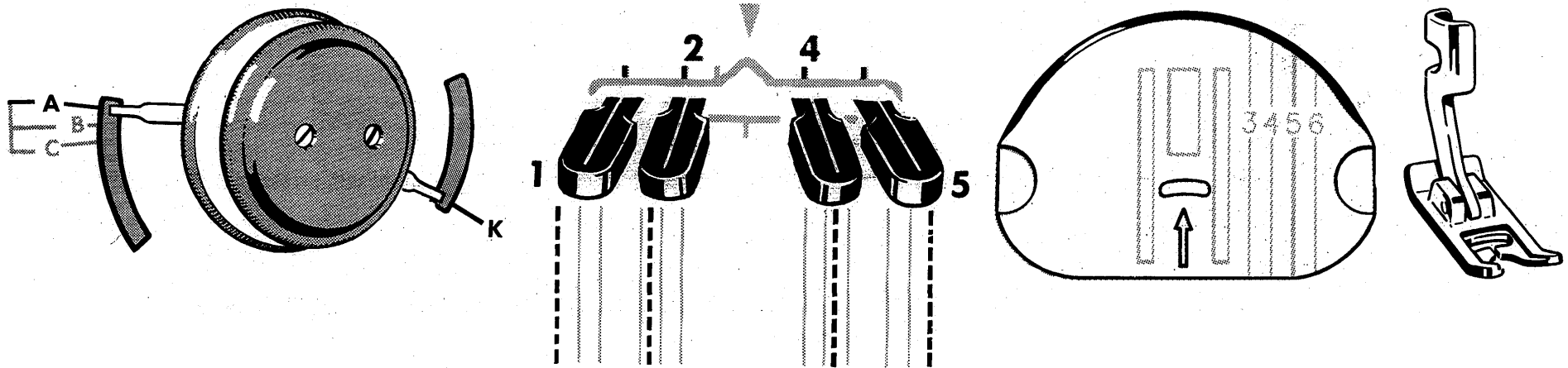

SET SELECTOR AT A K.
 RED LEVER AT 1, 2, 4 OR 5.
 GENERAL PURPOSE THROAT PLATE AND PRESSER FOOT.

Do not make red lever adjustments while the needle is in the fabric.

To meet special requirements a line of stitching may be placed to the right or left of center.

Red Lever settings 1 and 2 locate stitching to the left. Settings 4 and 5 place it to the right. Intermediate settings may also be used.

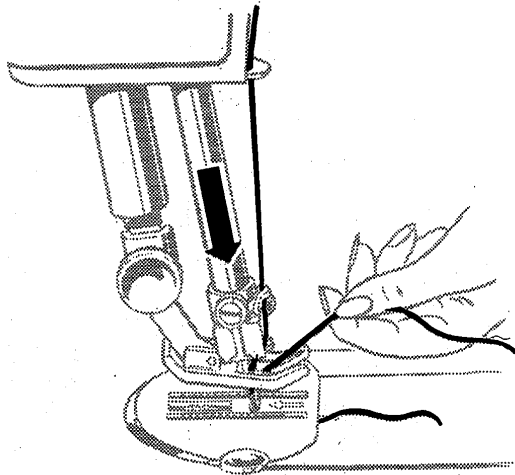
PREPARE TO SEW

Hold needle thread lightly with left hand. Turn hand wheel so that needle enters plate and brings up bobbin thread.

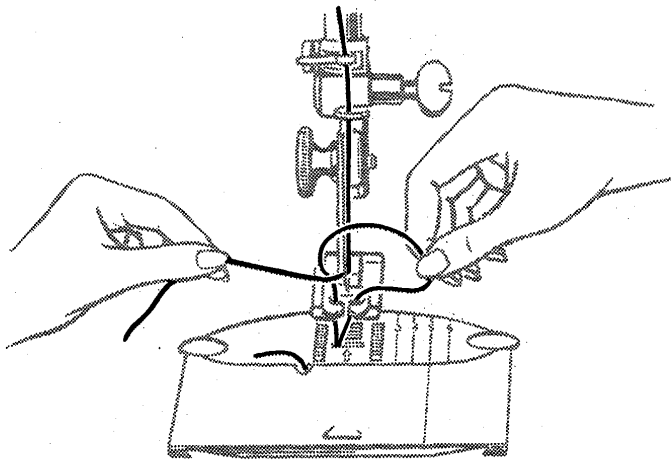
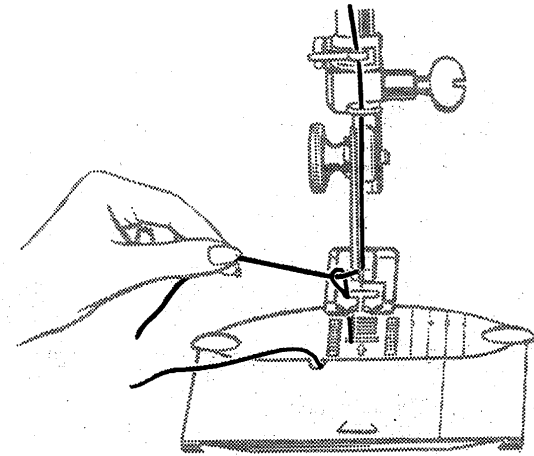

Pull end of bobbin thread through plate and place both needle and bobbin threads diagonally under presser foot.

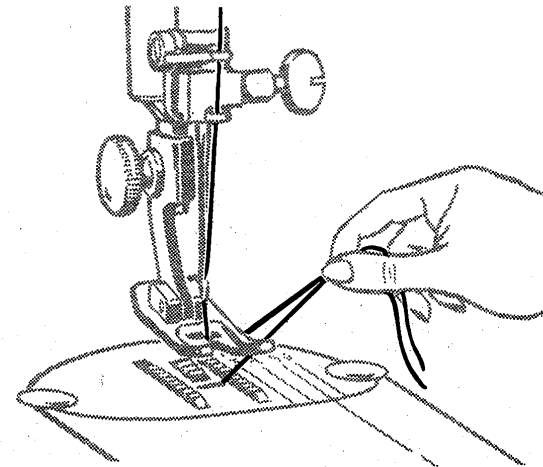

SEWING A SEAM

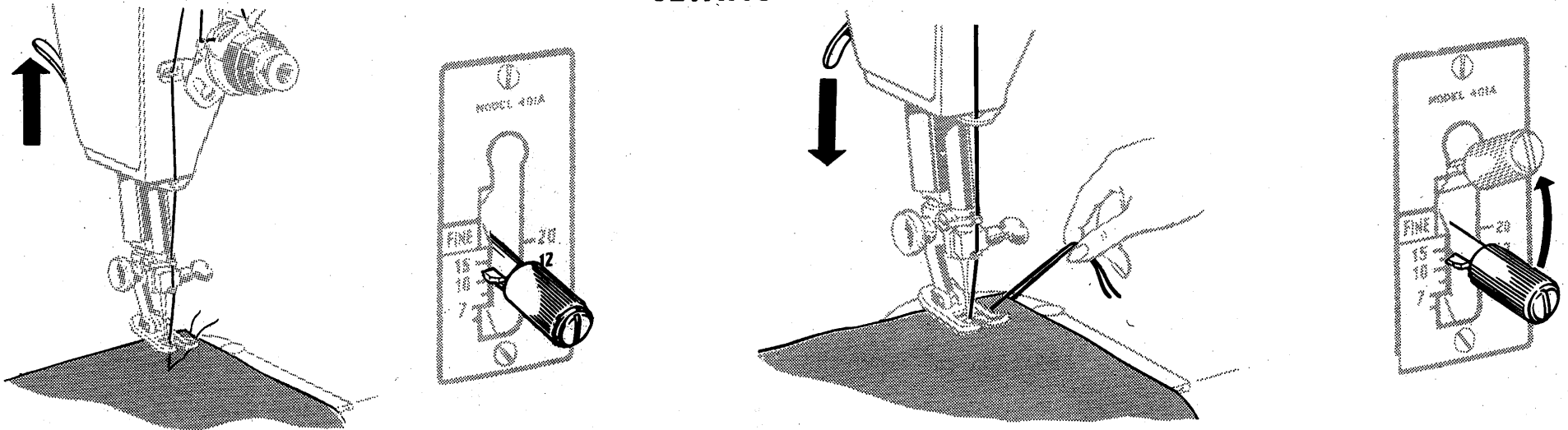

Set stitch regulator for stitch length desired. Position needle into fabric about $\frac{1}{2}$ inch from edge and lower presser foot. Raise stitch regulator to reverse.

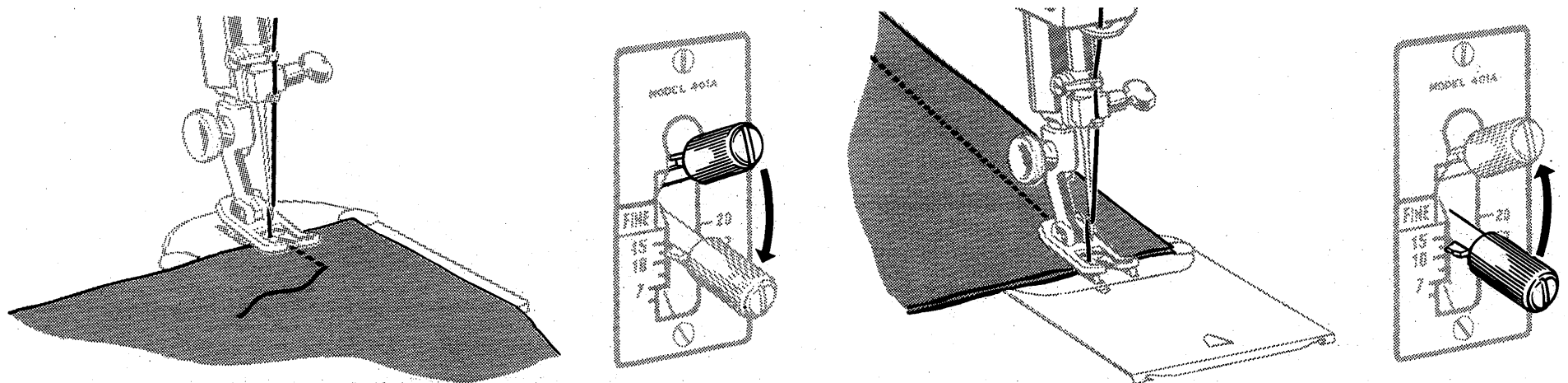

Back stitch to edge of fabric for reinforcement. Lower regulator for forward stitching of seam. Raise stitch regulator.

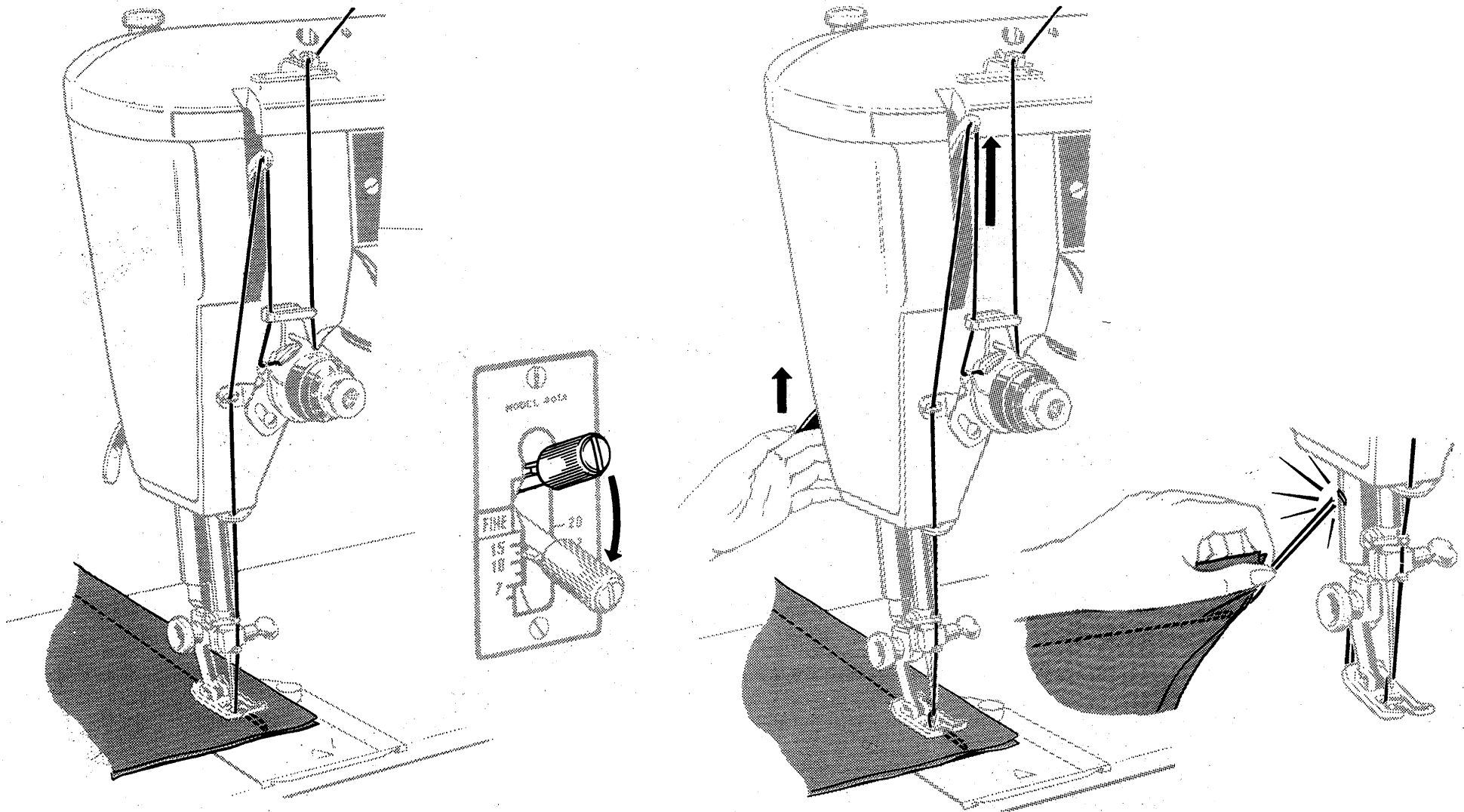

Back stitch to reinforce end of seam, and lower regulator to forward stitching position.

With take-up lever at highest point, raise presser foot and remove fabric.

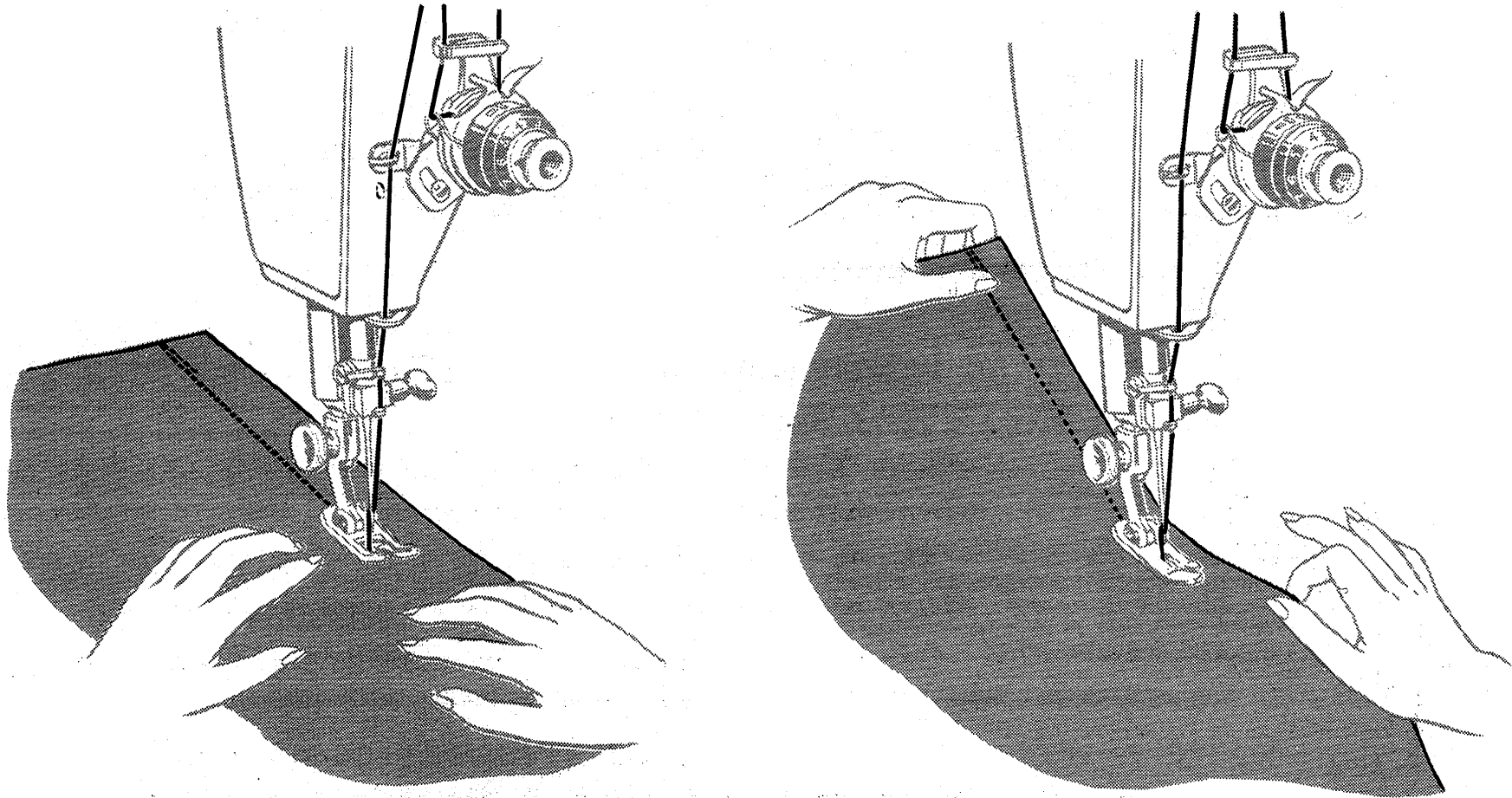
GUIDING AND SUPPORTING FABRIC

Most fabrics need only to be guided in front of the presser foot. Fabrics of unusual texture and weave, filmy sheers, crepes, knits, tricots, etc., require support while being stitched. For such fabrics, use the straight stitch throat plate and presser foot, and apply gentle tension to the seam by holding the fabric in front and in back of the presser foot as illustrated.

PRESSURE ADJUSTMENTS

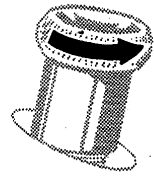
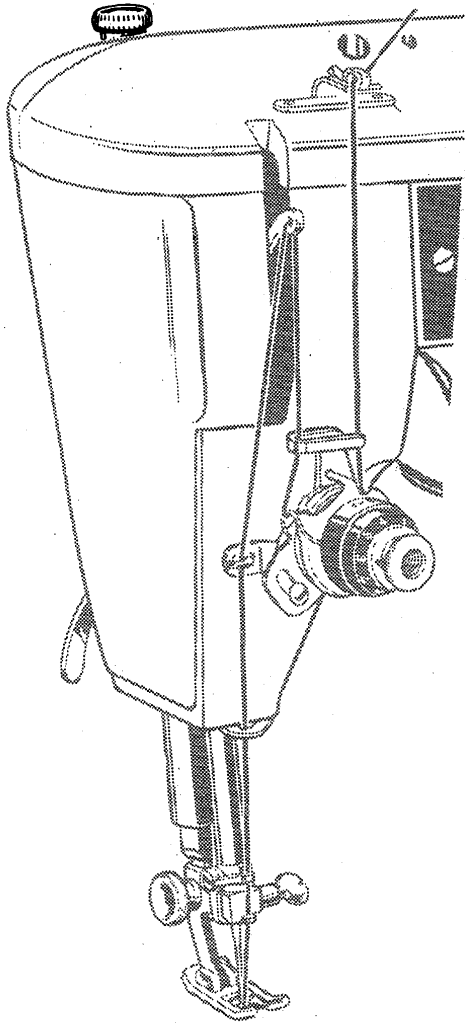

Decrease



Increase

To decrease pressure, turn thumb screw upward.
To increase pressure, turn screw downward.

Pressure is the force the presser foot exerts on fabric while it is being stitched.

Smooth, even handling of several thicknesses of fabric results when pressure is correctly regulated.

Too light a pressure will result in irregular feeding which affects both quality of stitch and evenness of seams.

Too heavy a pressure not only affects stitch and seam quality but will mar smooth surfaces and pile fabrics.

Surface finish, as well as the weight and texture of the fabric, must be considered in determining the amount of pressure needed.

NEEDLE THREAD TENSION STRAIGHT STITCHING

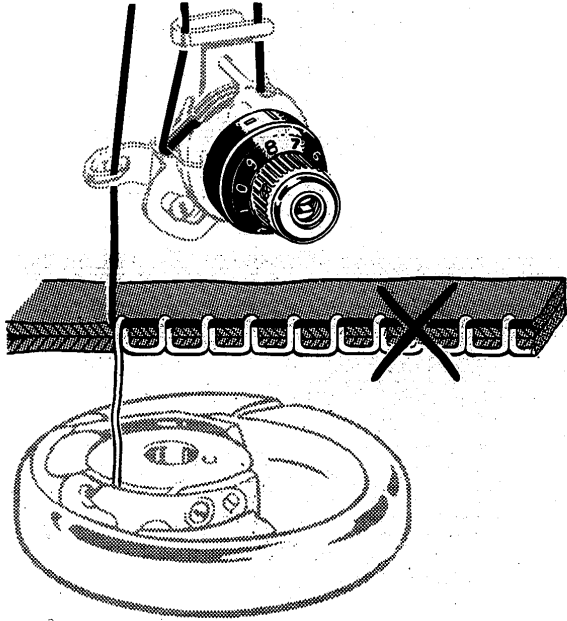

Needle thread tension too tight — correct by setting dial to lower number.

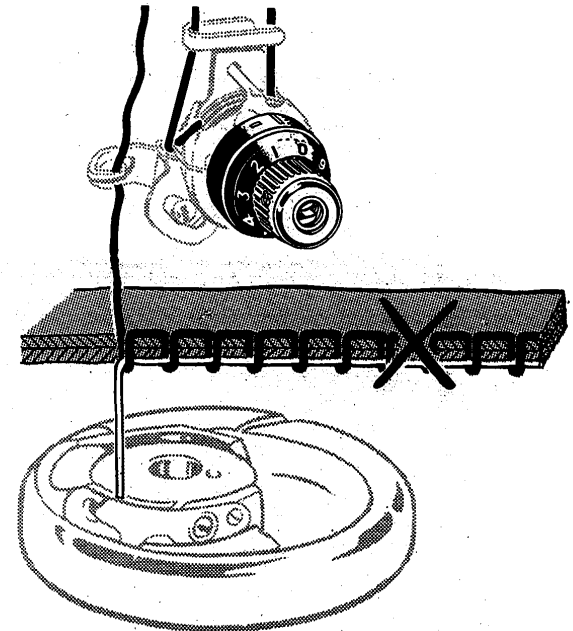
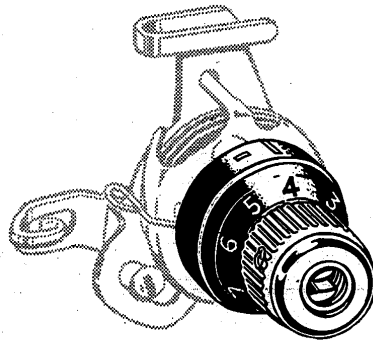

Needle thread tension too loose — correct by setting dial to higher number.

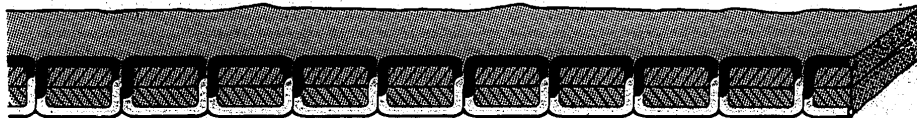

A perfectly locked stitch results with upper and lower tensions balanced so that needle and bobbin threads are drawn equally into fabric.

BOBBIN THREAD TENSION STRAIGHT STITCHING

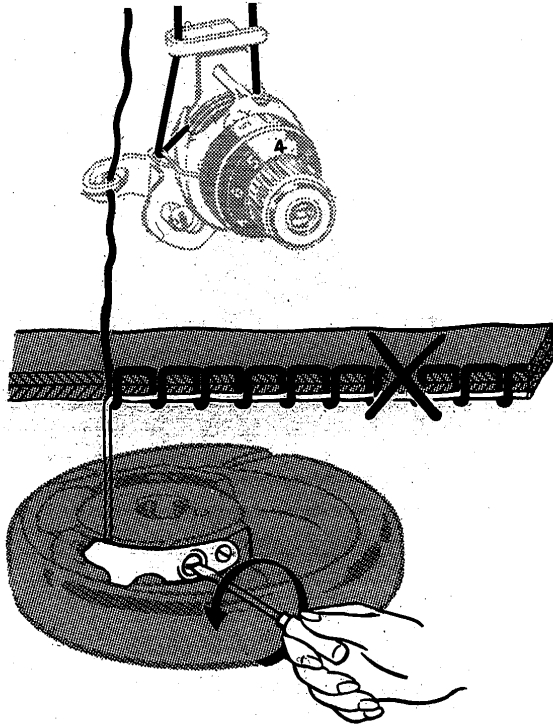

Bobbin thread tension too tight—correct by turning screw counterclockwise.

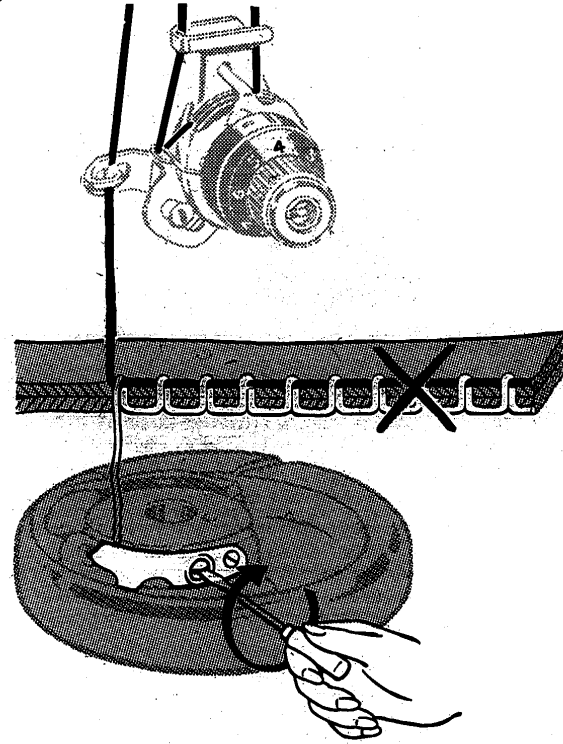

Bobbin thread tension too loose—correct by turning screw clockwise.

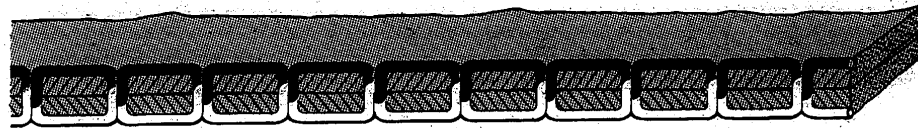

A perfectly locked stitch results with the upper and lower tensions balanced so that needle and bobbin threads are drawn equally into fabric.

ZIGZAG STITCHING EQUIPMENT

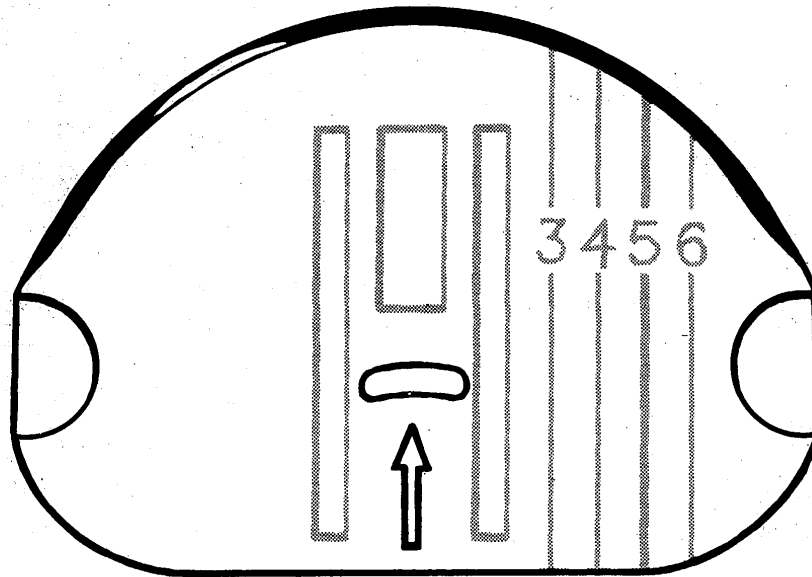

GENERAL PURPOSE THROAT PLATE.

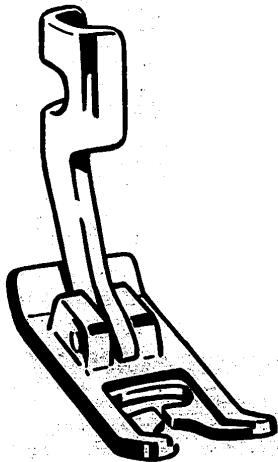

GENERAL PURPOSE PRESSER FOOT.

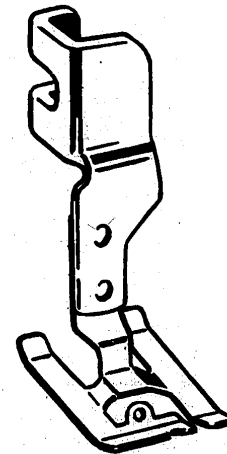

SPECIAL PURPOSE PRESSER FOOT.

STITCH LENGTH ADJUSTMENT FOR SATIN STITCHING

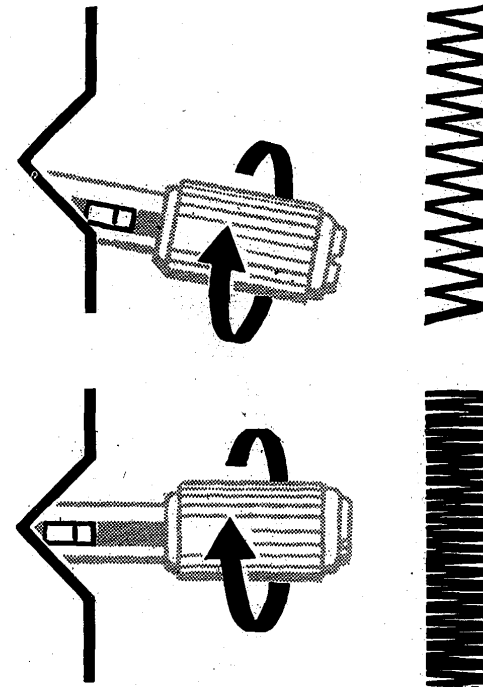
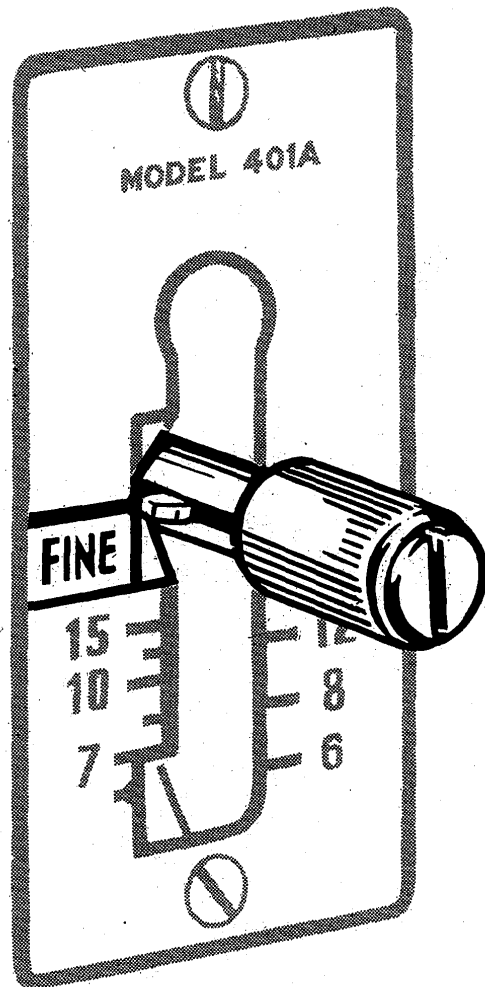

The "fine" area of the stitch regulator with its inclined surface provides a means of gradually shortening the stitch length.

As the knob is turned, the pointer rides up the incline until a closed satin stitch is obtained.

The exact stitch setting will vary with the texture of the fabric. It is advisable to make a test on a scrap of self fabric, using the Special Purpose Foot, before proceeding with the actual work.

SATIN STITCH TENSION ADJUSTMENT

Satin stitching requires a lighter needle thread tension than straight stitching or open designs. The wider the satin stitching the lighter the tension required.

Wide satin stitching, Red Lever at 5, requires the least amount of tension. For narrower satin stitching slightly more tension should be used.

To determine correct tension setting, a test sample should be made on self fabric using the Special Purpose Foot. A properly balanced satin stitch should lie flat across the material. Any tautness or puckering indicates too high a needle thread tension.

Some soft fabrics may require the addition of a backing to insure good stitching results. Crisp organdy and lawn are suitable for this purpose.

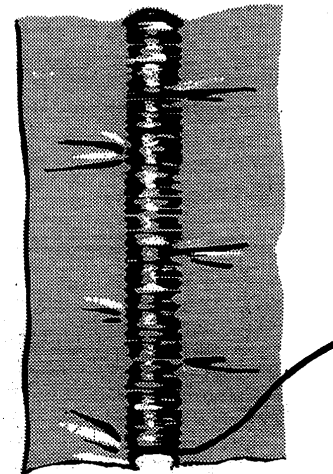
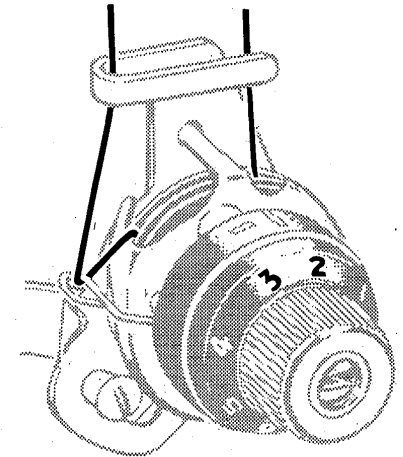
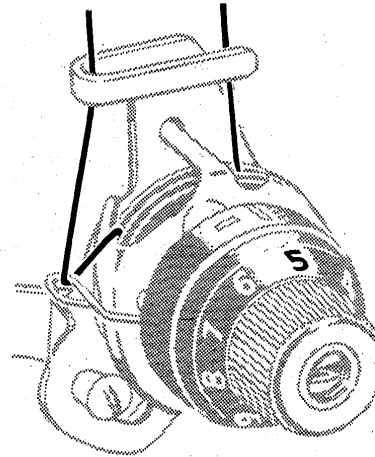

Tight needle thread
tension

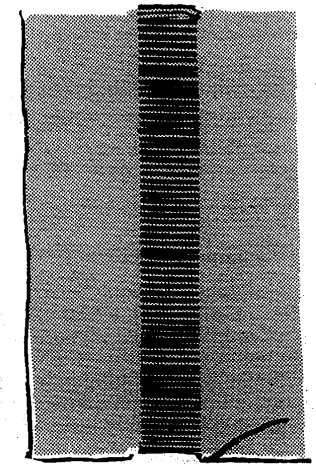

Correct needle thread
tension

PRIMARY PATTERNS

See pages 14 and 15 for operation of Red Lever and Selector.

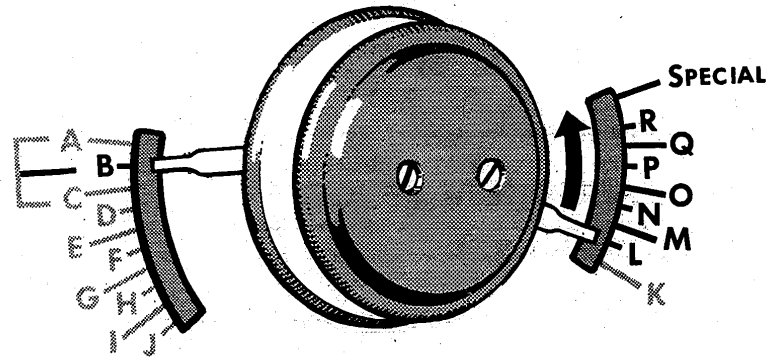

SELECTOR SETTINGS L THROUGH SPECIAL CONTROL PRIMARY PATTERNS.
 SELECTOR SETTING B PLACES STITCHING IN CENTRAL NEEDLE POSITION.
 RED LEVER CONTROLS WIDTH OF PRIMARY PATTERNS.
 Do not make selector or red lever adjustments while the needle is in the fabric.

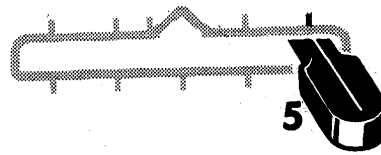

S
S
P
E
C
I
A
L

**PRIMARY PATTERNS
SPECIAL DISCS**

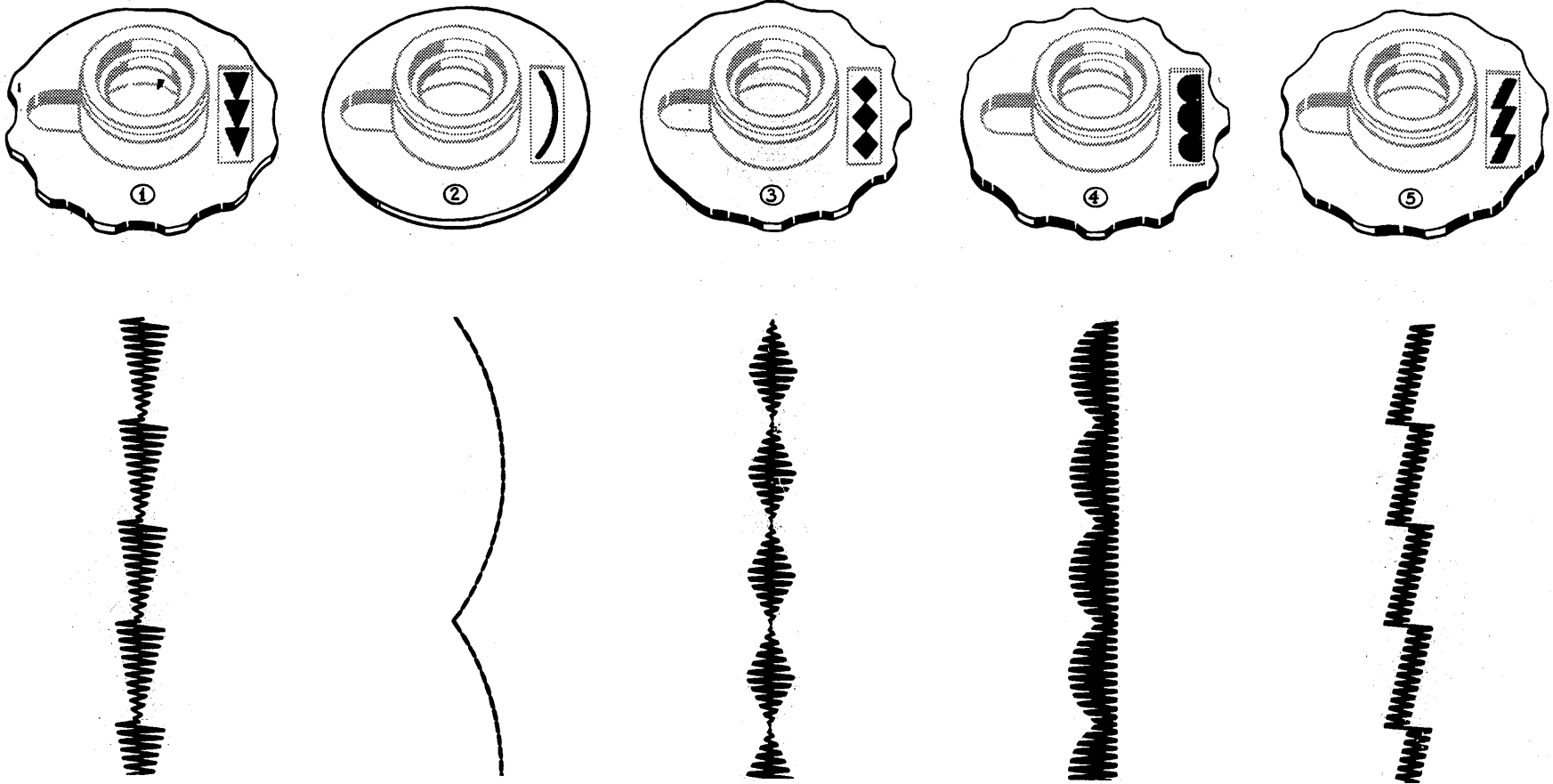

These five interchangeable Special Discs, classified as Primary Patterns, are included with the machine. Each produces an individual design. Circled numbers (for example ②) in this book indicate Special Disc numbers.

PRIMARY PATTERNS REPLACEMENT OF SPECIAL DISCS

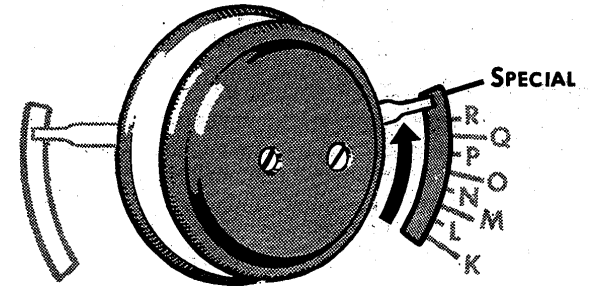
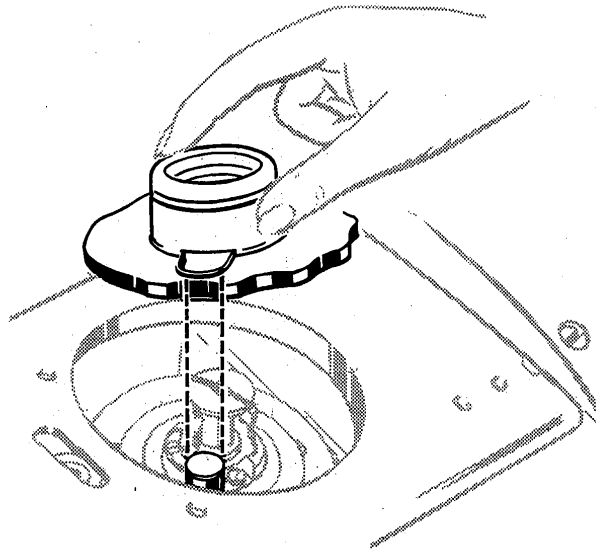
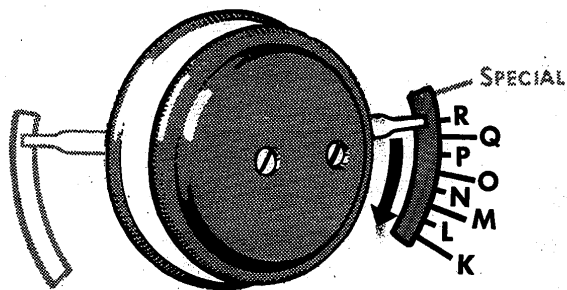
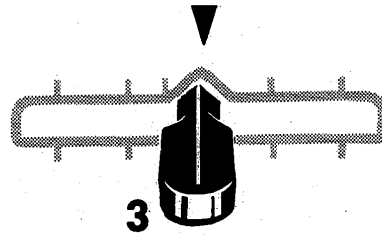

To replace any of these discs, move right hand pointer of Selector off Special. Raise the stitch chart at top of the machine. Remove disc and place another disc onto spindle, pushing downward until disc snaps in place. Set right hand pointer on Special to engage the disc.

PRIMARY PATTERNS RED LEVER CONTROL OF WIDTH

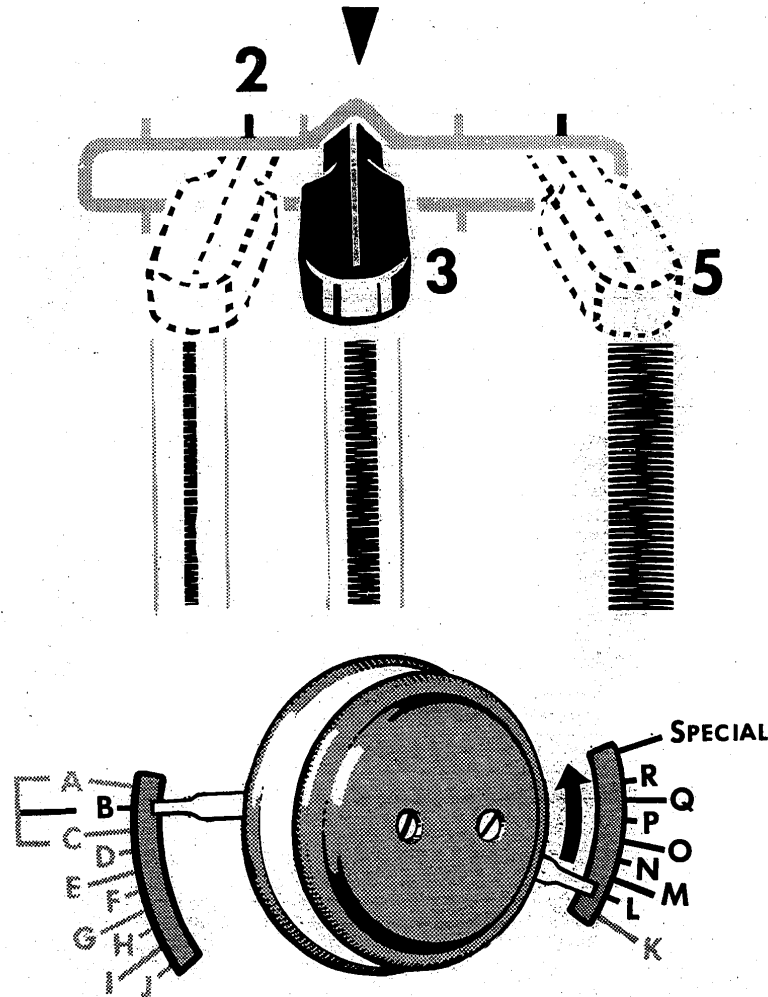

The width of Primary Patterns is controlled by the Red Lever. Settings range from a maximum of 5 to a minimum of 2.

PRIMARY PATTERNS NEEDLE POSITIONS

Selector setting of B places stitching in central needle position. Selector settings A and C place the stitching in left and right needle positions at widths less than 5

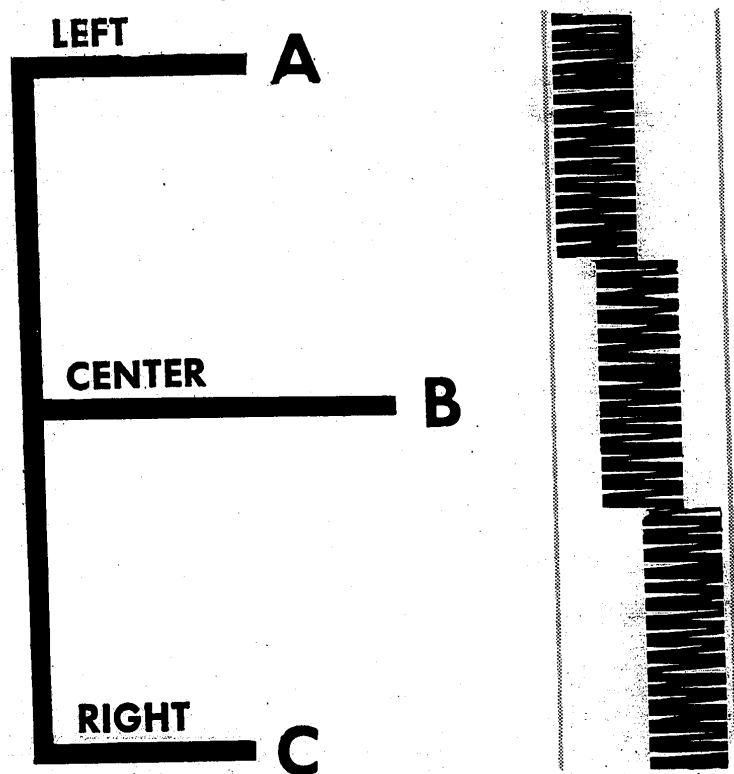

Selector setting B is preferred. Settings A and C are only used when special placement of stitching is desired. For example: buttonholes, button sewing, blind stitching.

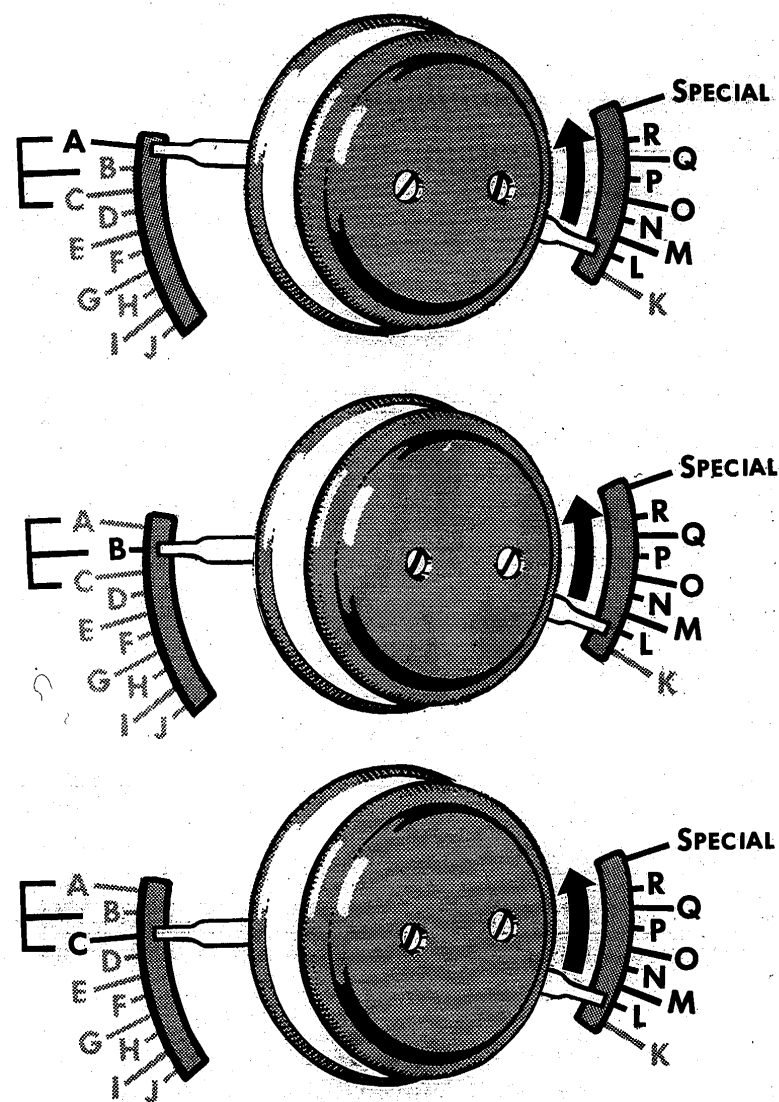

COMBINATION PATTERNS AND VARIATIONS

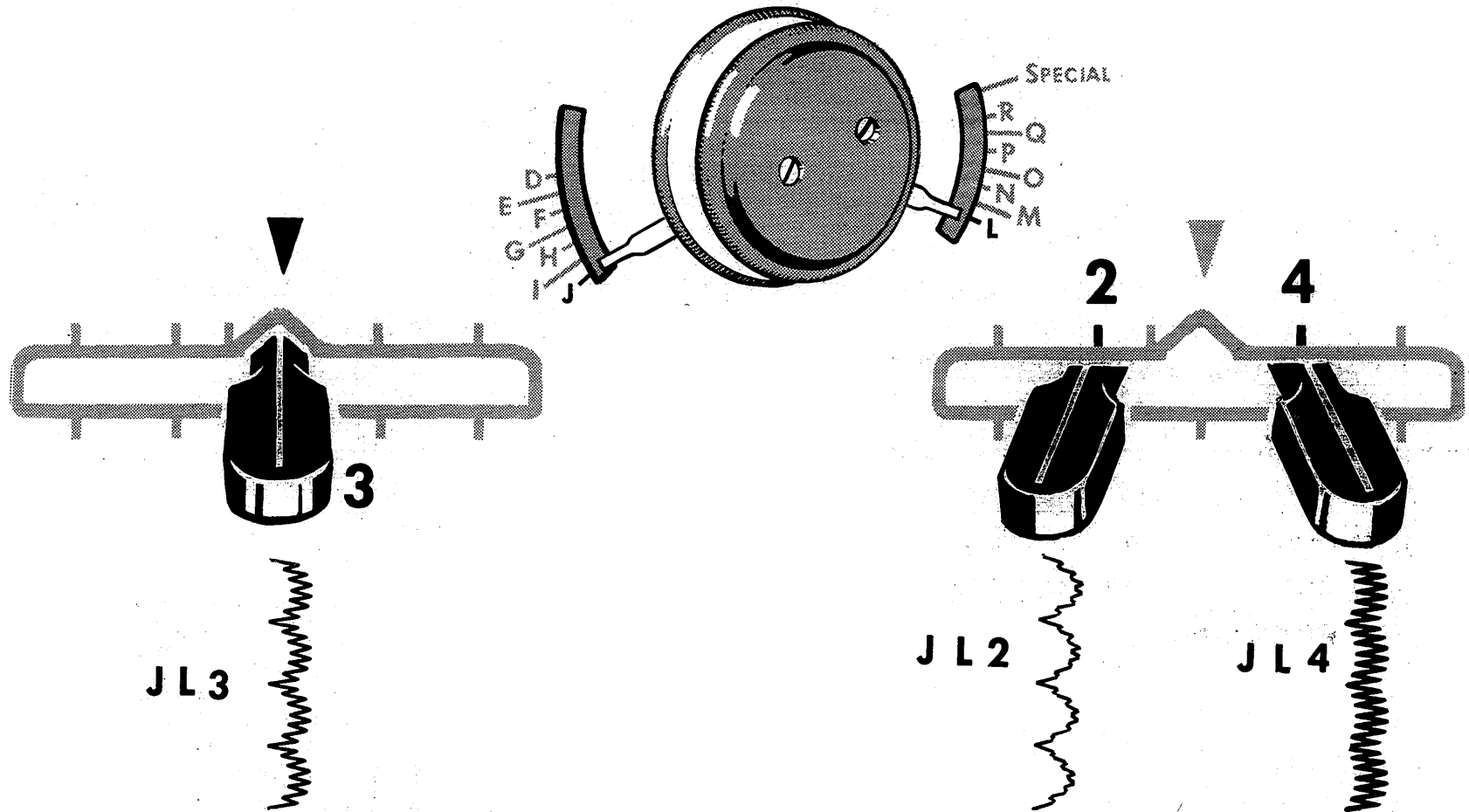

A great variety of additional stitch patterns can be created by combining any left hand Selector setting from D through J with any right hand Selector setting from L through Special.

A Red Lever setting of 3 results in a Combination Pattern. Settings of 2 and 4 produce Variations.

TWO NEEDLES

The needle clamp accommodates two 15 x 1 needles, generally of the same size. However, where special effects are desired, needles of different sizes may be used together, with corresponding threads. Loosen the thumb screw and insert the additional needle from the right. (See page 6 for procedure.)

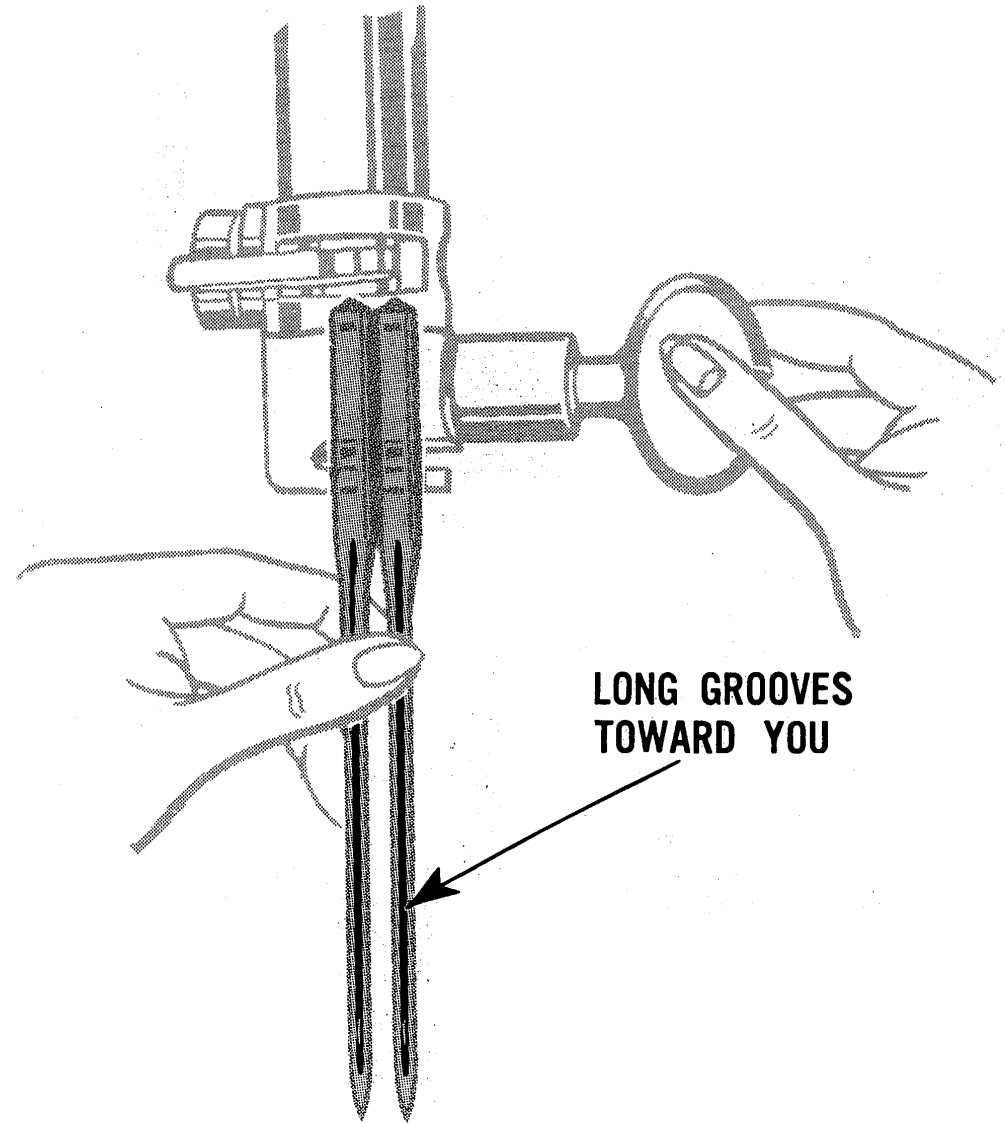

TWO NEEDLES UPPER THREADING

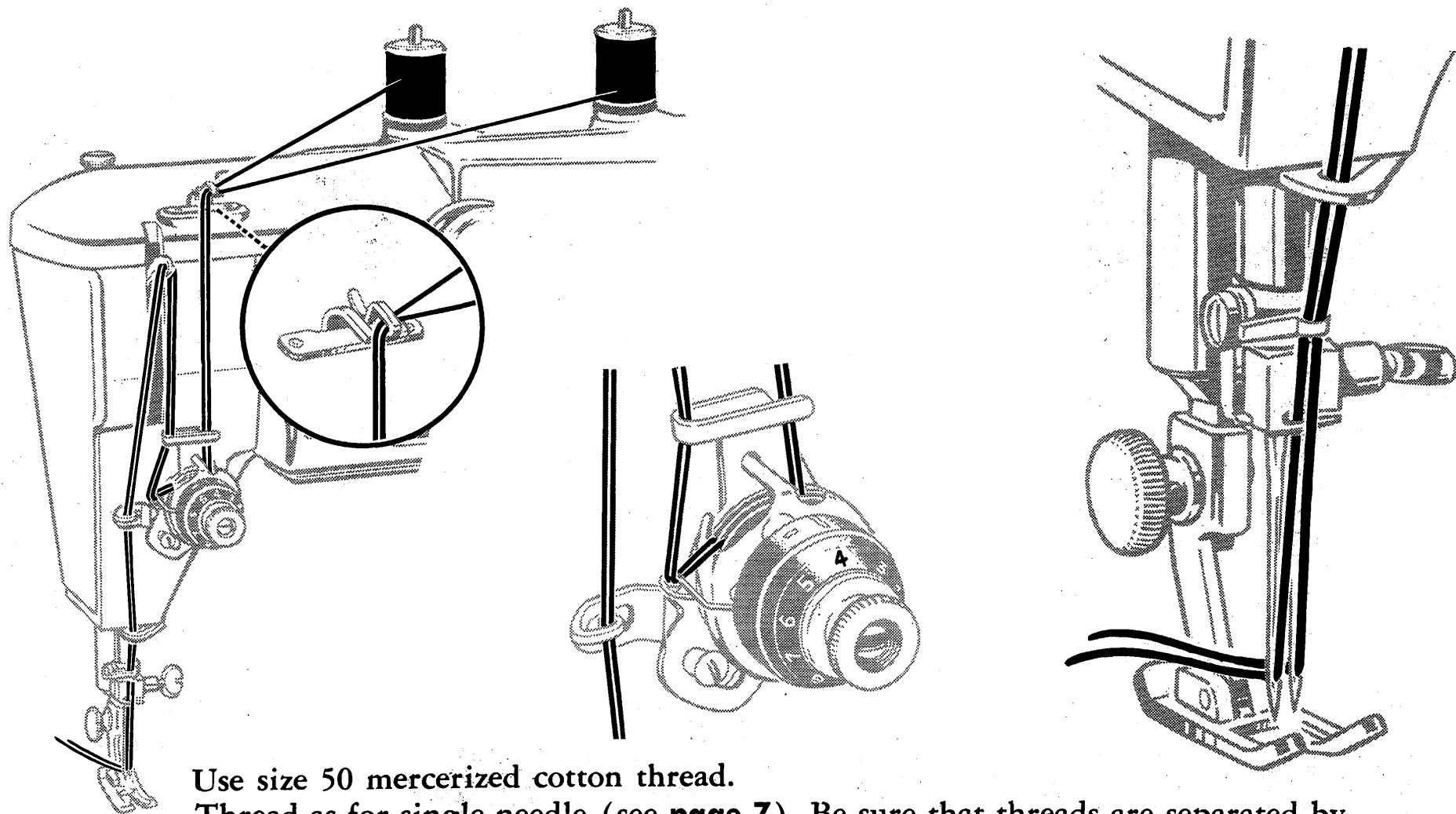

Use size 50 mercerized cotton thread.

Thread as for single needle (see **page 7**). Be sure that threads are separated by the center tension disc.

Carry only one thread through the last guide before the needle.

**TWO NEEDLES
STRAIGHT STITCHING A K 2**

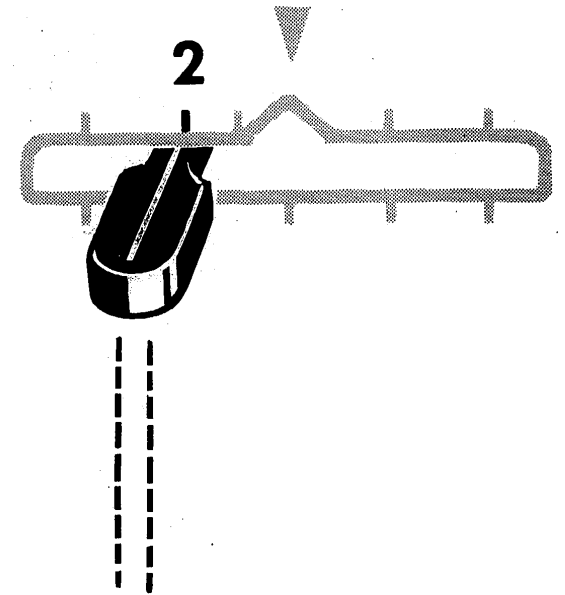
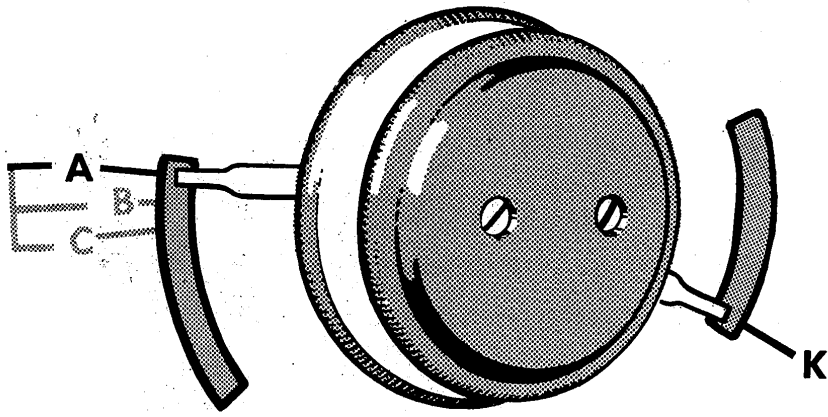

SELECTOR SETTING: A K.
RED LEVER: 2 ONLY.
GENERAL PURPOSE FOOT AND THROAT PLATE.

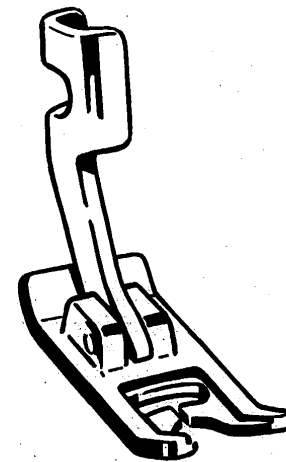
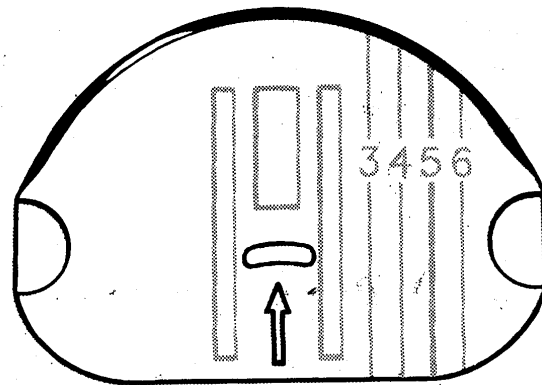

TWO NEEDLES PRIMARY PATTERNS

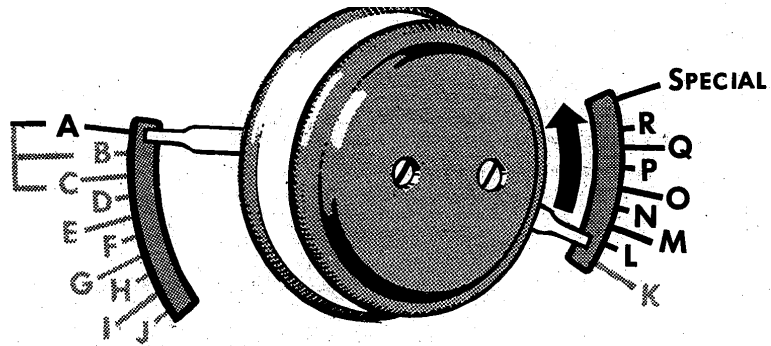

SELECTOR SETTING: A - L THROUGH SPECIAL.
 RED LEVER: 2 OR 3 MAXIMUM.
 GENERAL PURPOSE THROAT PLATE.
 GENERAL PURPOSE FOOT OR SPECIAL PURPOSE FOOT

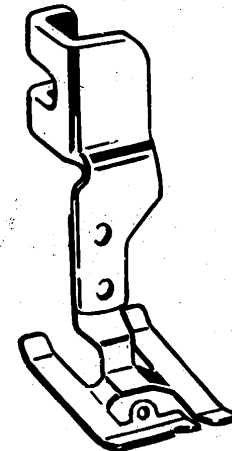
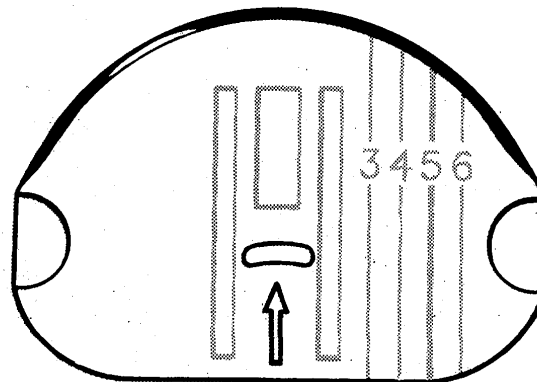
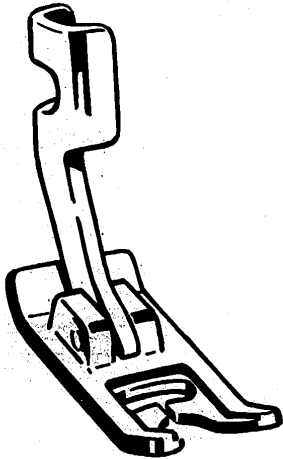
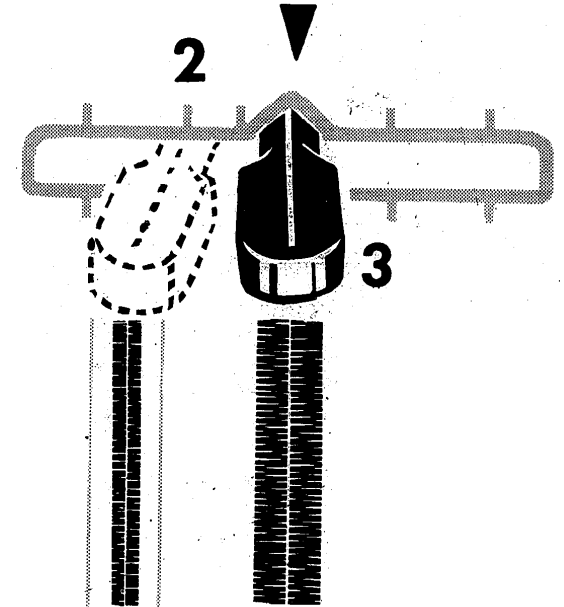

SPECIAL PURPOSE FOOT

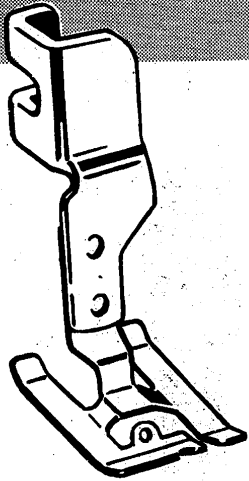

This light, flexible foot is designed for satin stitching. It provides maximum visibility and maneuverability while allowing closely spaced zigzag stitches to feed freely.

It is ideal for accurate placement of satin stitching in buttonholes, monograms, motifs and applique work.

The eyelet on the left side of the foot accommodates a filler cord.

APPLICATIONS

Buttonholes
Applique
Monograms

Decorative Stitching
Couching
Motifs

BUTTONHOLES

SELECTOR: AL

RED LEVER: SEE BELOW

THROAT PLATE: GENERAL PURPOSE

SPECIAL PURPOSE FOOT

STITCH LENGTH: FINE

To establish the correct stitch setting and length of buttonhole, a sample must first be made.

Three Red Lever settings are available. Fabric weight will determine the selection.

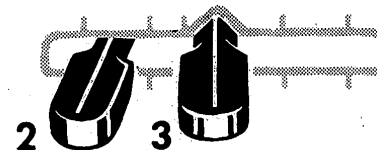
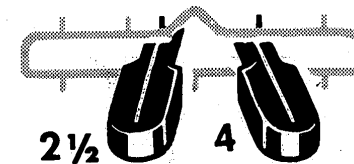
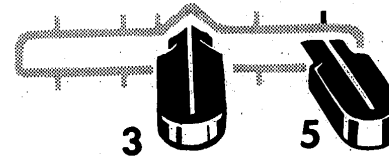

BUTTONHOLES

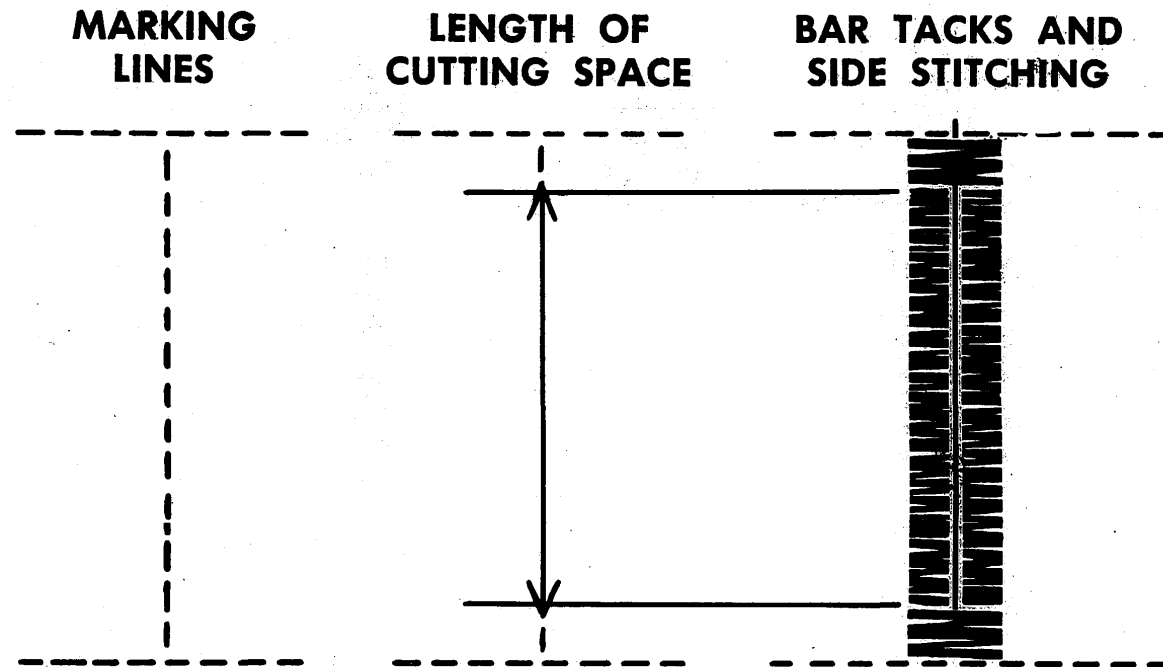

The length of cutting space, the opening through which the button passes, is measured by the width and thickness of the button.

The length of the finished buttonhole will be the cutting space plus $\frac{1}{8}$ inch for bar tacks.

Work a sample buttonhole in the same fabric as the garment. Use a double fold, duplicating a facing, and include interfacing if this has been used.

BUTTONHOLES

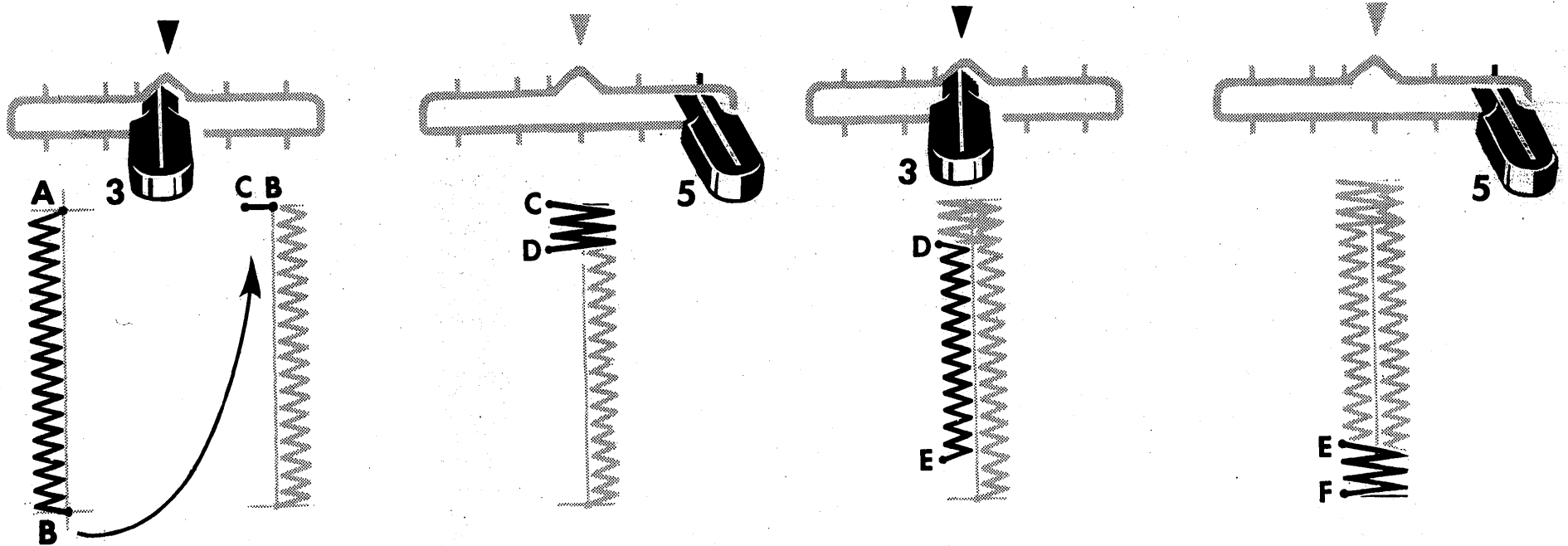

Stitching Procedure. Set Selector and Red Lever. Place work under the needle, aligning the center marking of buttonhole with center score line of foot.

To form side stitching, turn hand wheel toward you so the needle enters fabric at point **A**. Lower foot and stitch to end of marking. Leave needle in fabric at point **B**. Raise foot, pivot work on needle. Lower foot. Take one stitch without changing Red Lever setting, bringing work to point **C**. Adjust to Red Lever setting for bar tacks and take no less than six stitches. Stop at point **D**. Readjust to Red Lever setting for side stitching. Complete to point **E**, or approximately six stitches from the end of the buttonhole. Move to Red Lever setting for bar tacks and duplicate tack previously made, ending at point **F**.

BUTTONHOLES

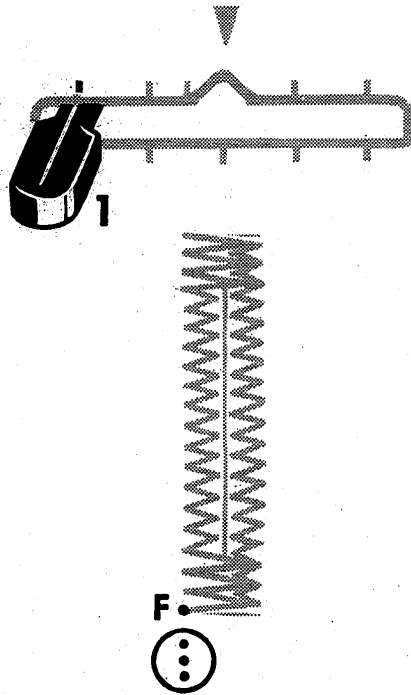

To secure stitching move Red Lever to #1 setting and take three stitches. Remove work, draw threads to the underside, fasten and trim.

With sharp embroidery scissors cut opening for button.

Raised or Corded Buttonholes. Both #8 pearl cotton and buttonhole twist make suitable filler cords for raised buttonholes.

Place the spool of filler cord on the second spool pin. Carry the cord through the first thread guide, straight down between the center and back tension discs, into the large thread guide and then through the eyelet on the Special Purpose Foot. Draw the cord under and in back of the foot and proceed as for regular buttonholes.

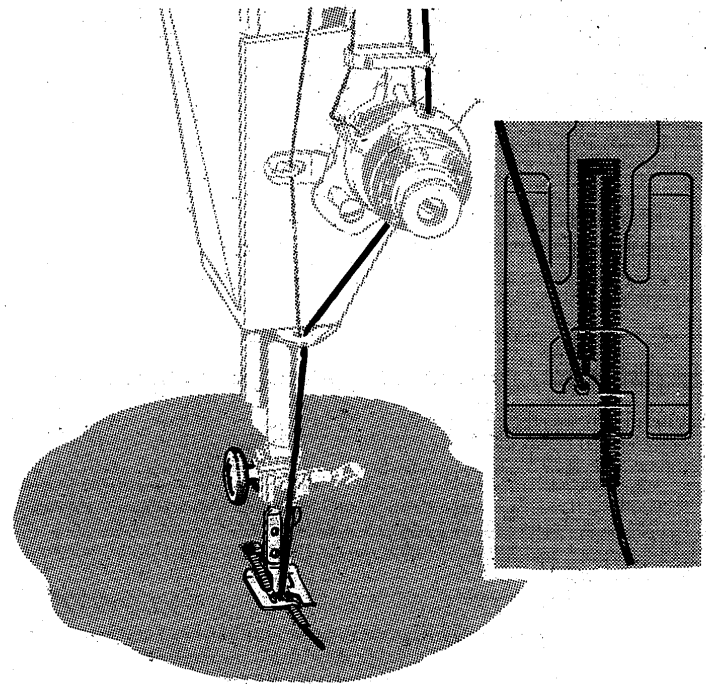

APPLIQUE

Applique adds beauty and interest to wearing apparel, linens and fabric furnishings.

Either contrasting or self fabric may be used effectively. The most versatile stitch in appliqueing is a closely set zigzag stitch (Primary Pattern BL). The width of this stitch may be varied to accommodate weaves and textures of fabrics. Combination Patterns and Variations present many interesting ways to applique with decorative stitching.

Preparation. There are two methods by which applique work may be done. The appropriate method is determined by the fabric being used, and a test sample is advisable.

Position the design properly and baste it to the fabric. Attach the Special Purpose Foot to the presser bar.

Method #1. Set Selector and Red Lever for the desired stitch pattern. Following the shape of the design, outline it entirely with applique stitching. Any excess fabric on the outer edges is trimmed away after the stitching has been completed.

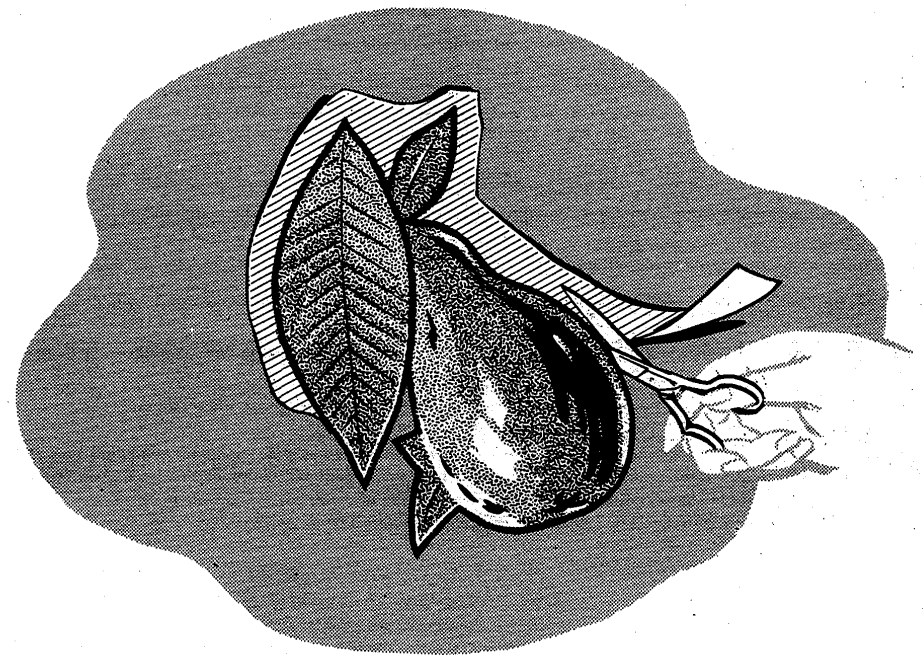

APPLIQUE

Method #2. Set Selector and Red Lever to AK3 for straight stitching. Outline the entire design with a short stitch. Trim the raw edges down to the stitching.

Set Selector and Red Lever to the stitch pattern desired, and overedge the design with this stitching. A smooth, lustrous finish results, which requires no additional trimming.

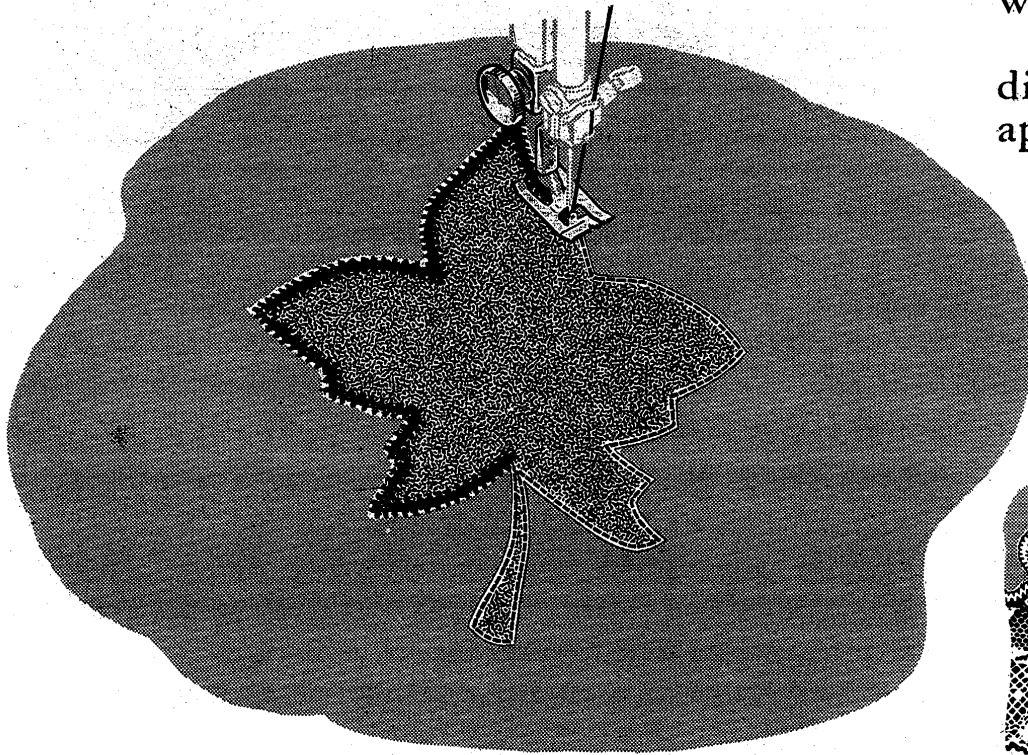

Corded Applique. The Special Purpose Foot, which provides for a filler cord, is perfect for corded applique work. Gimp, crochet thread or buttonhole twist are generally used.

See **page 43** for threading.

Either method of appliqueing may be used when cording is desired. The only change in procedure is the introduction of the cord, over which the applique stitching is formed.

This stitching technique results in a raised, dimensional effect, and is an ideal finish for lace applique.

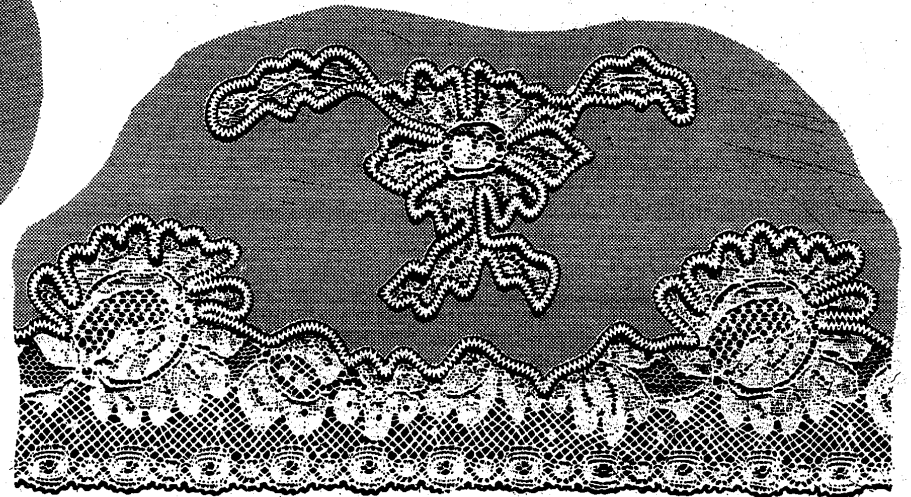

MONOGRAMS AND MOTIFS

Any of the many stitch patterns are perfect for monograms and motifs.

Select a design from the many transfer patterns available or sketch one to suit your purpose.

Some fabrics may require a backing of lawn or organdy.

Position the design on the right side of the material. Trim backing away when stitching is completed, if necessary.

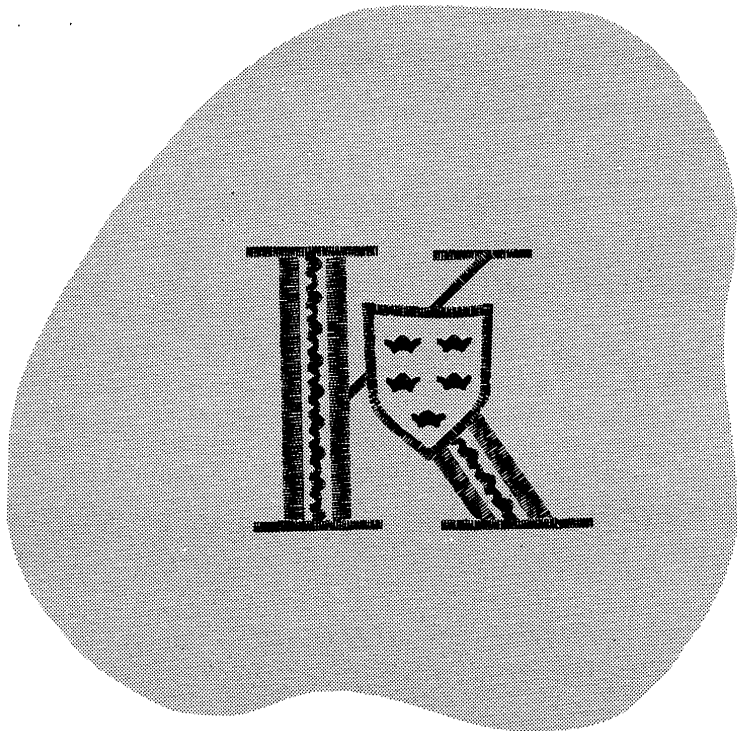

To reproduce a specific portion of a stitch pattern, first stitch on a scrap of material until the desired point in the design is reached.

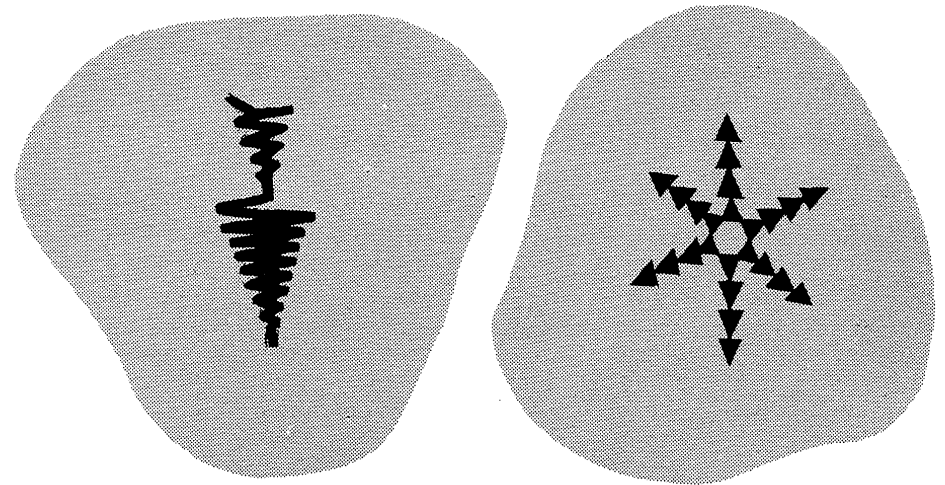

Remove the material from under the presser foot. Now position motif or monogram under the needle. Lower presser foot and stitch.

This procedure is recommended for all precise design placement. Leaves, and flower petals, for example, are created in this way.

(See pages I and J for illustrations of sewing samples.)

SEAMING SHEERS

SELECTOR: B L

RED LEVER: 2

THROAT PLATE: GENERAL PURPOSE

SPECIAL PURPOSE FOOT

STITCH LENGTH: FINE (ABOVE 25)

A dainty hair-line finish is particularly desirable for the inside seams of sheer collars, facings and yokes. Seam allowances that ordinarily show through are eliminated.

Both heavy duty thread and tatting thread make suitable filler cords (see **page 43** for threading).

Follow the seam outline covering the cord. Cut away seam allowance close to line of stitching.

Turn and press.

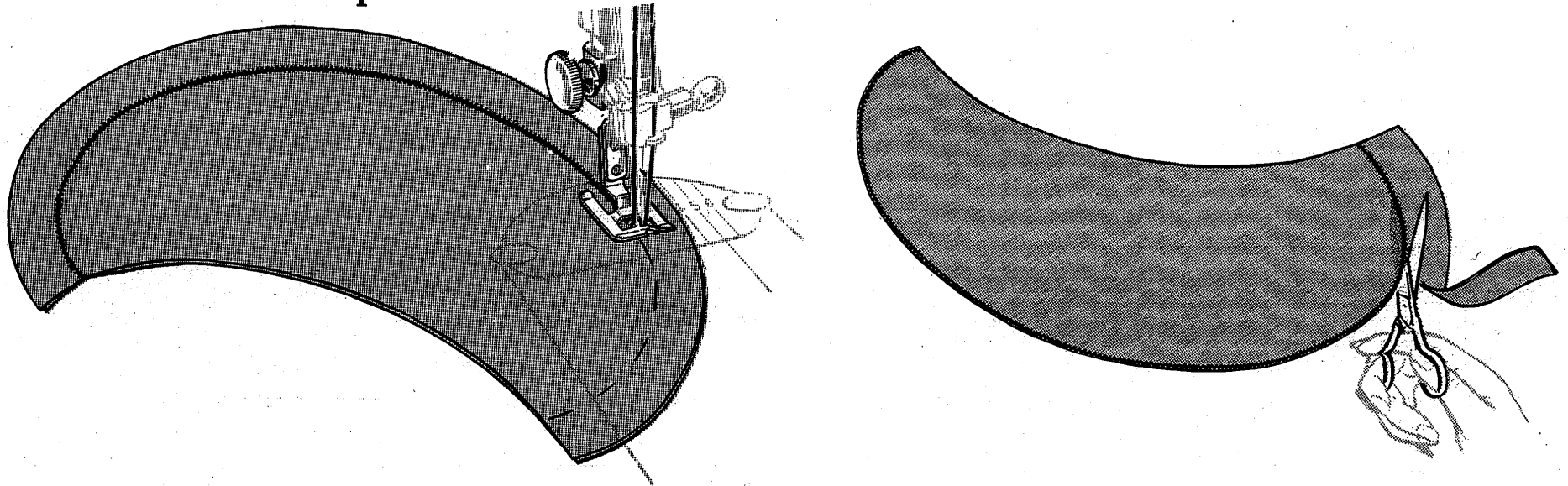

COUCHING

Novel effects are obtained by couching gimp, yarn or braid with stitch patterns.

Spaced patterns are the most appropriate as they allow the decorative cords to show as part of the design.

The Special Purpose Foot is ideally suited to this work.

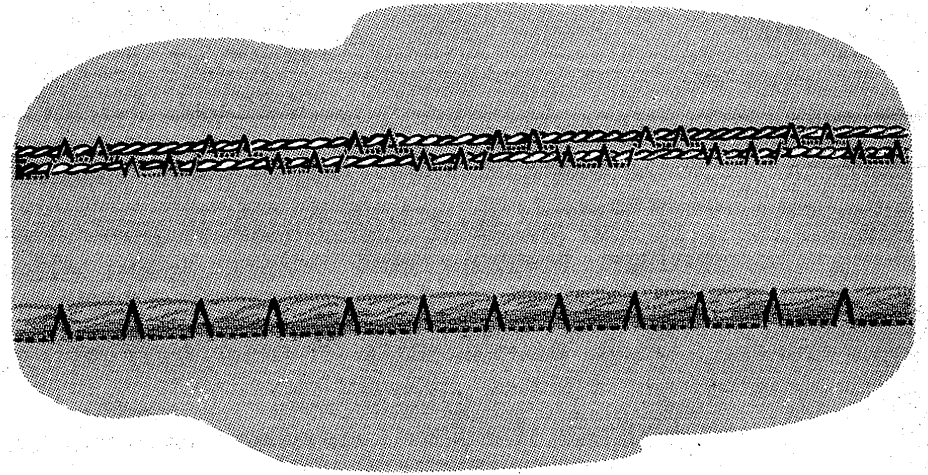

LACE EDGING AND INSERTION

Delicate and durable zigzag stitching is especially appropriate for the application of lace edgings and insertions.

Many decorative stitch patterns can be used effectively serving as both finish and trim.

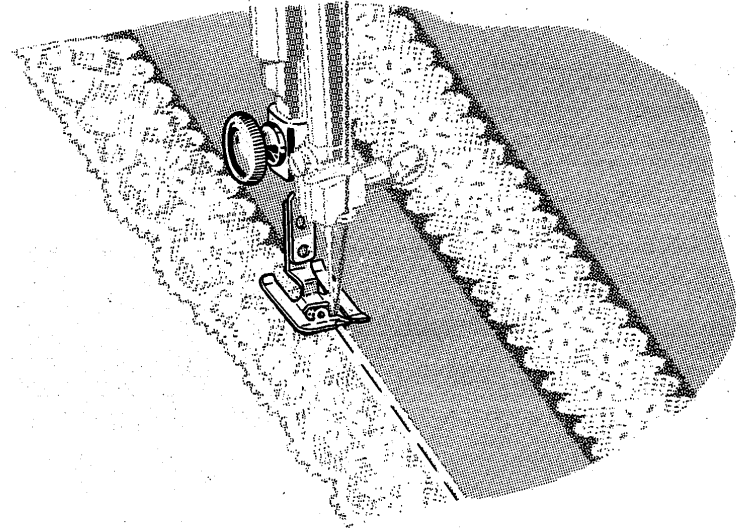

A

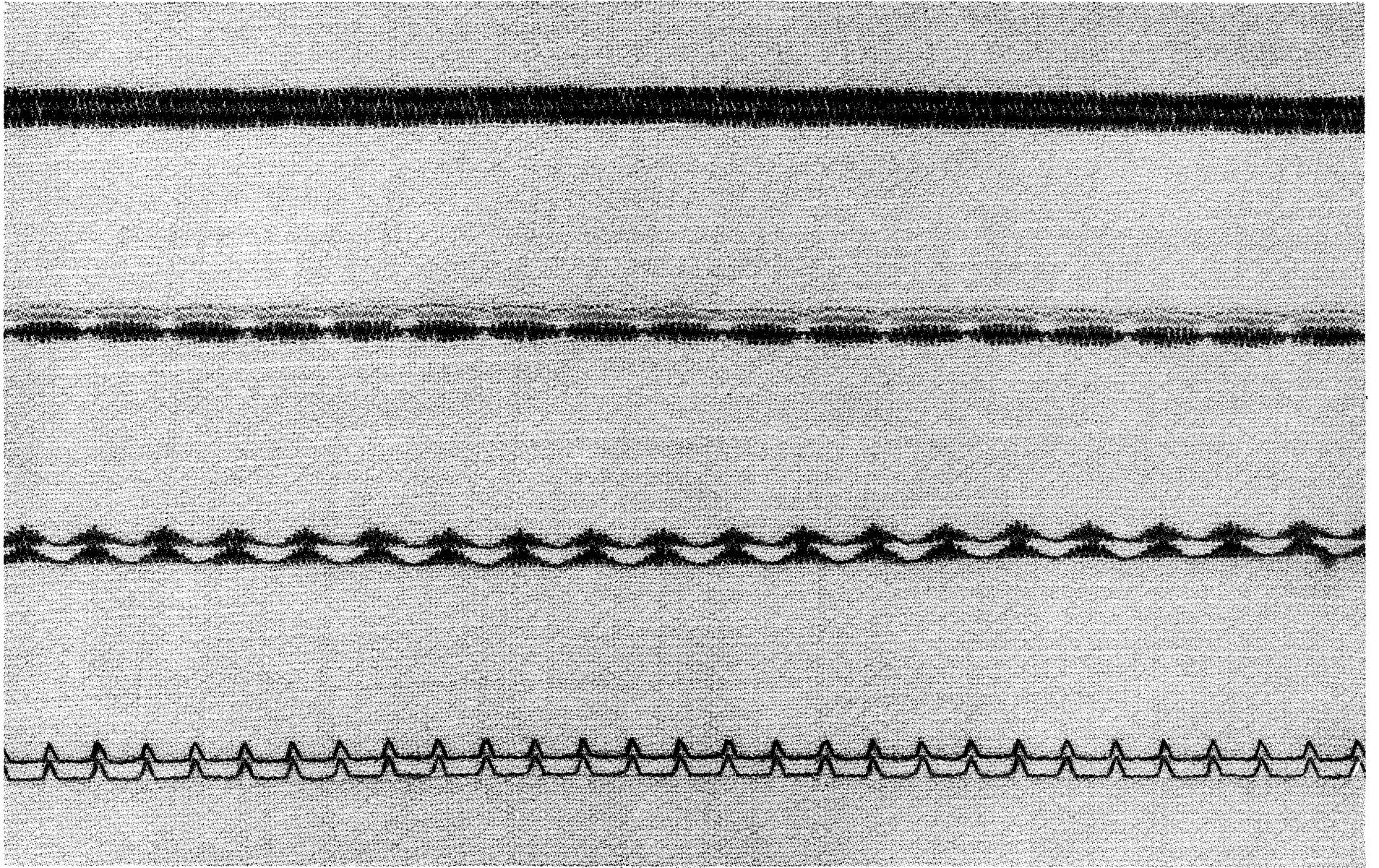

B

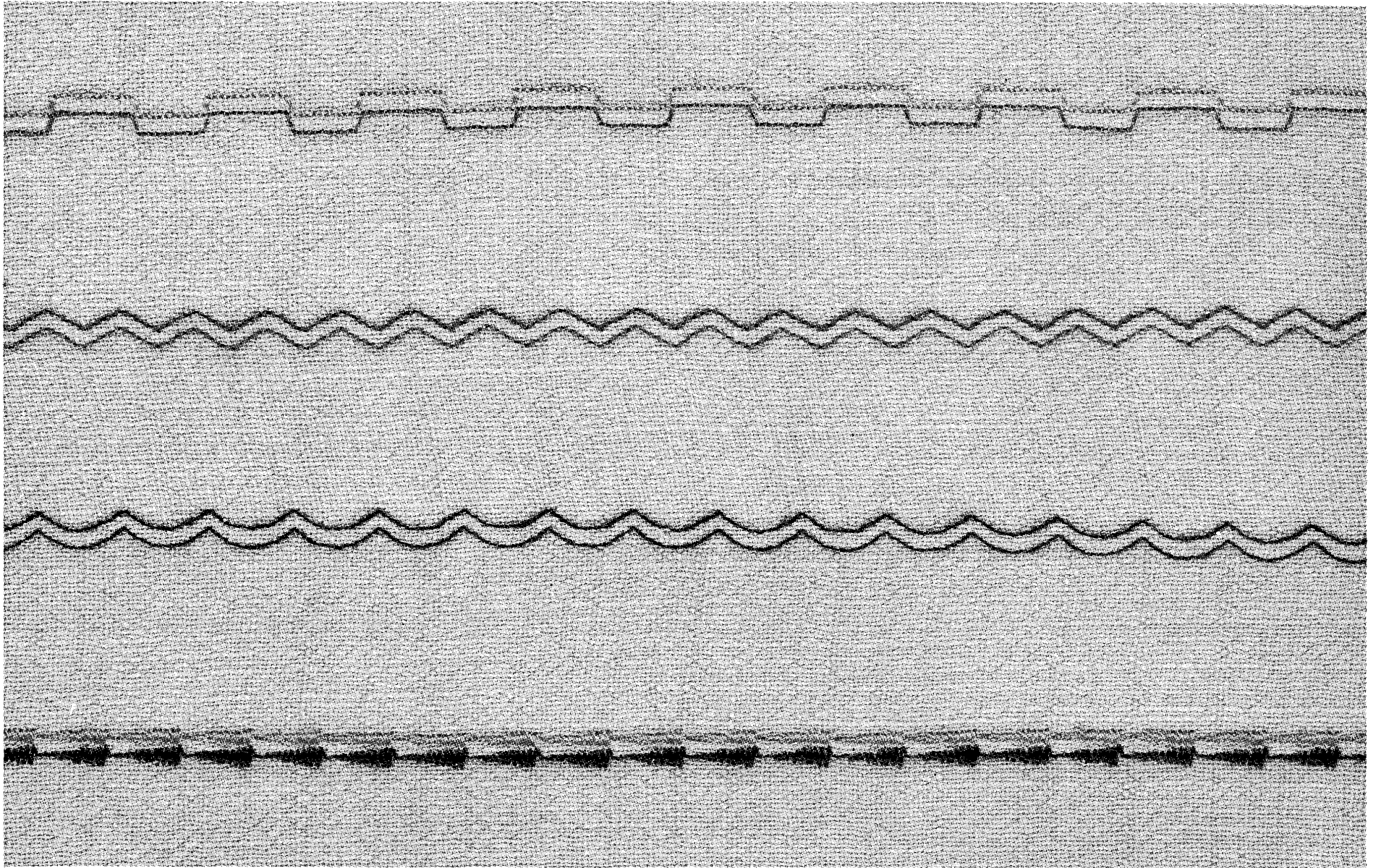

C

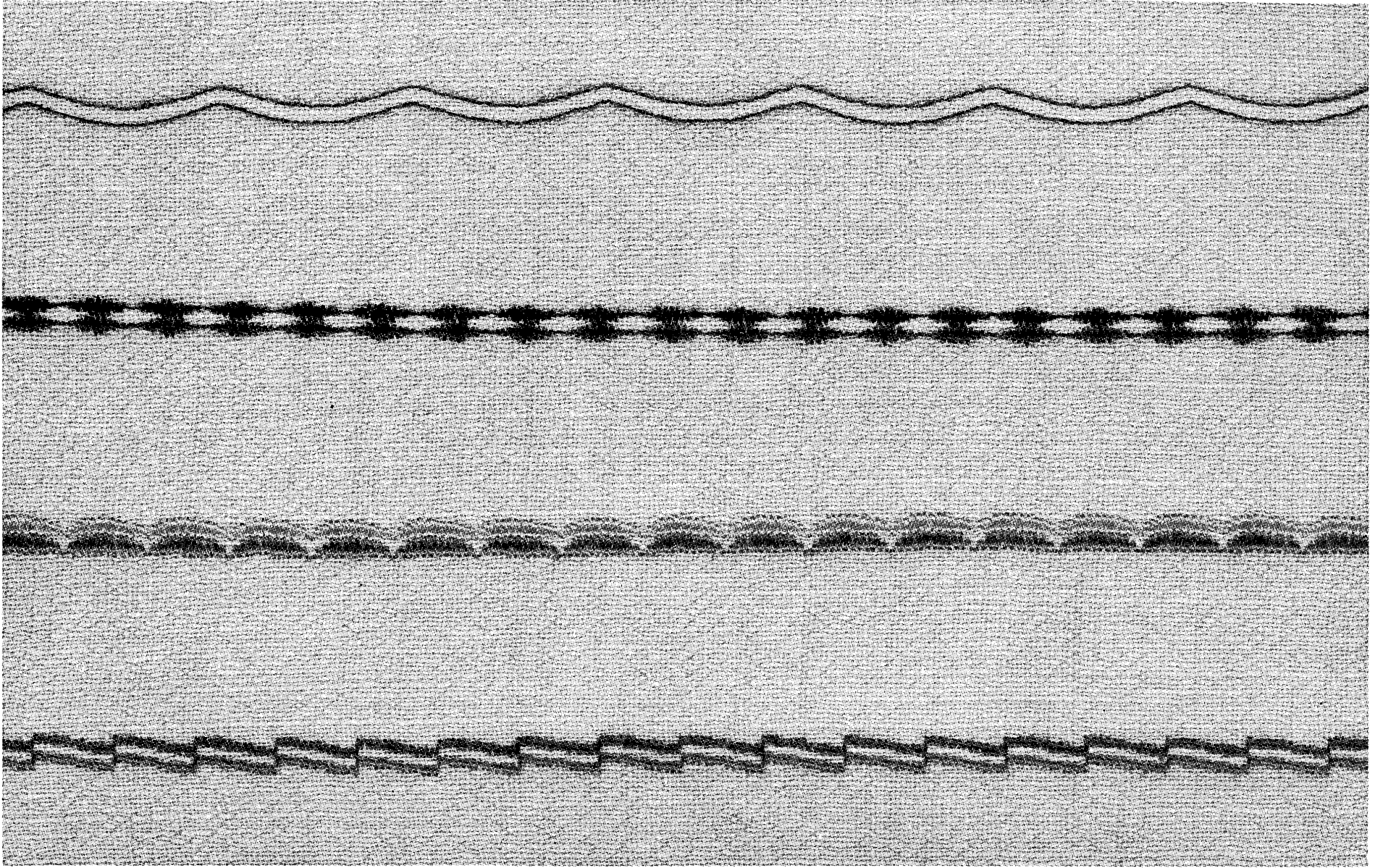

D

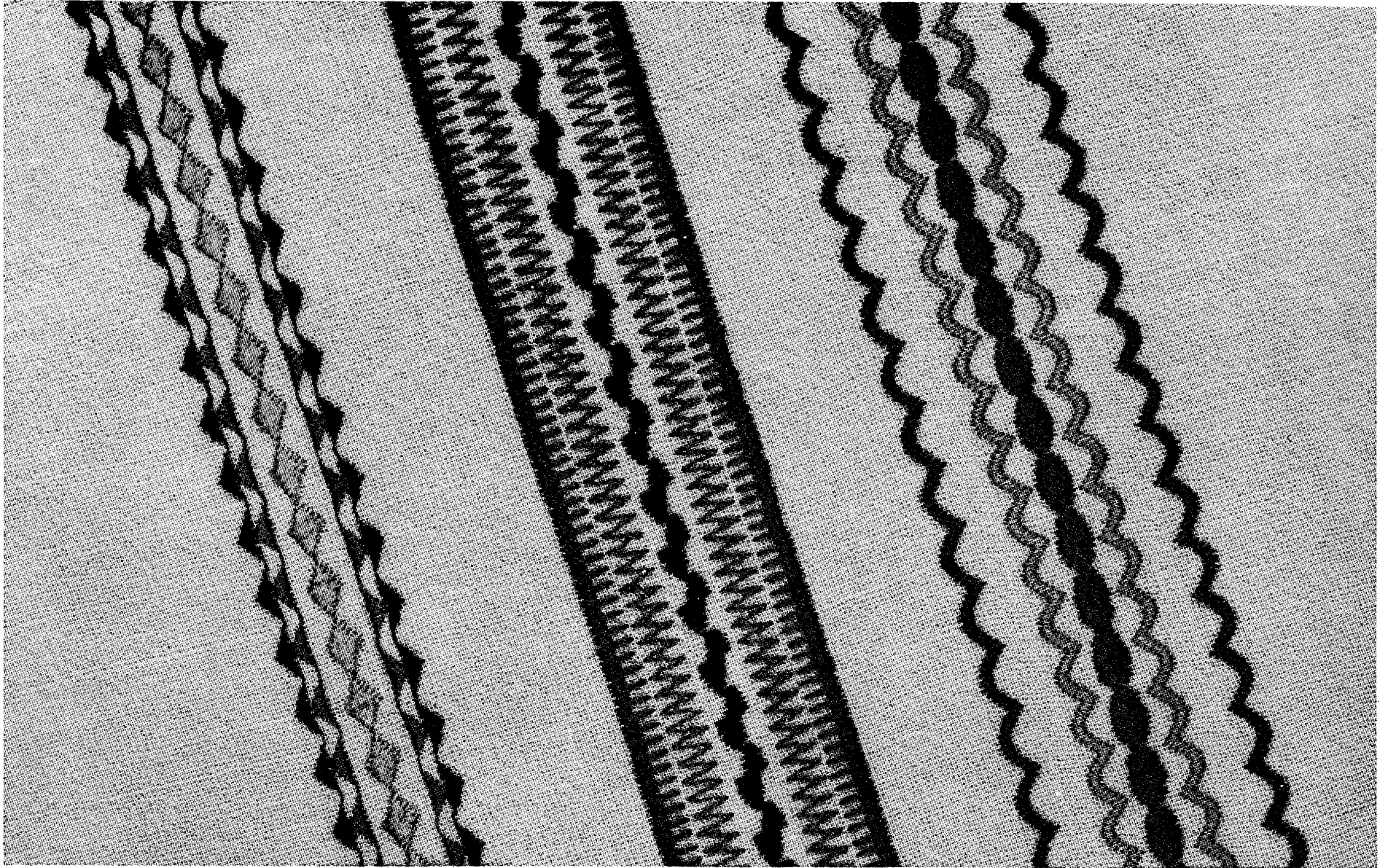

E

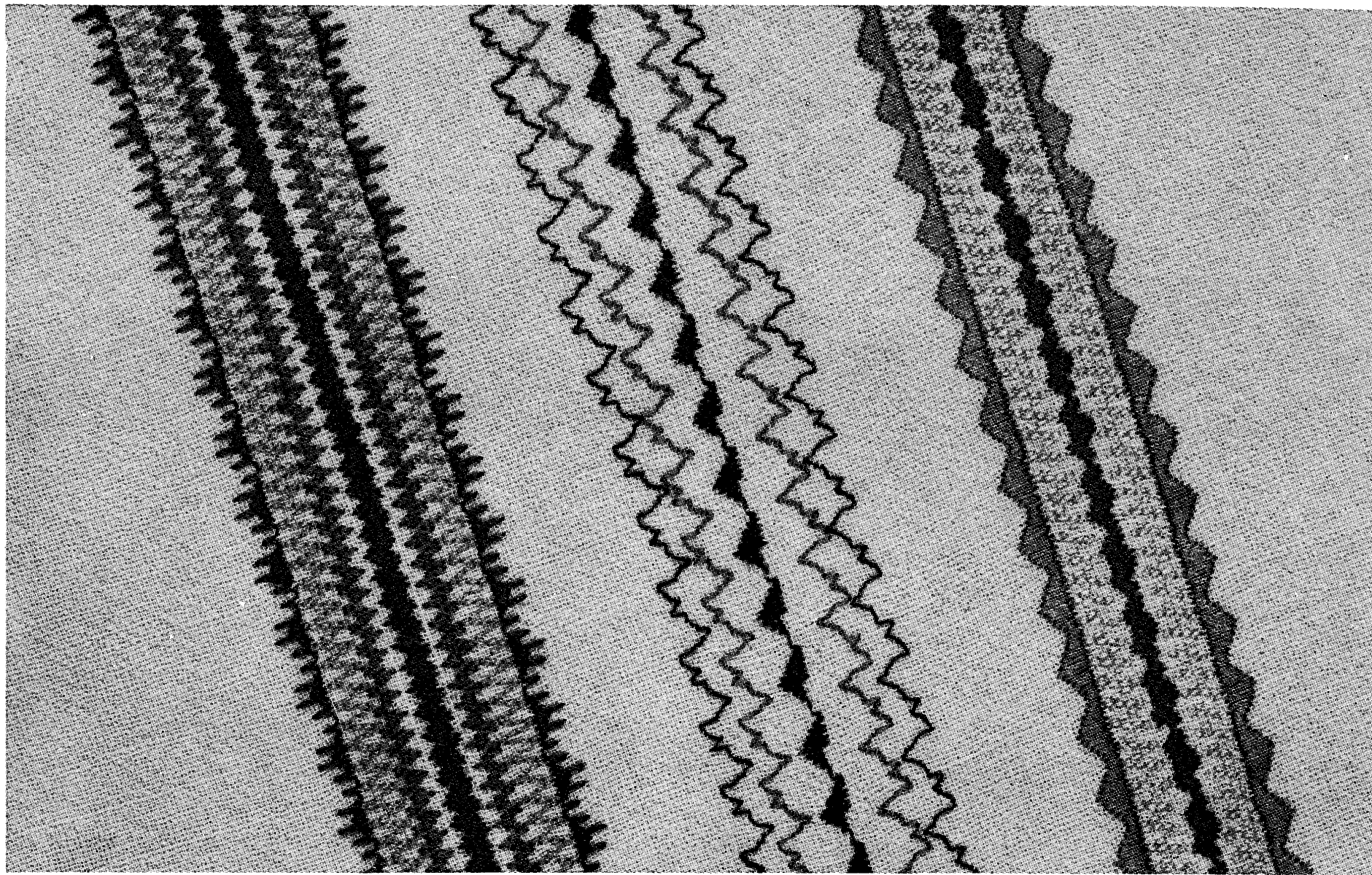

F

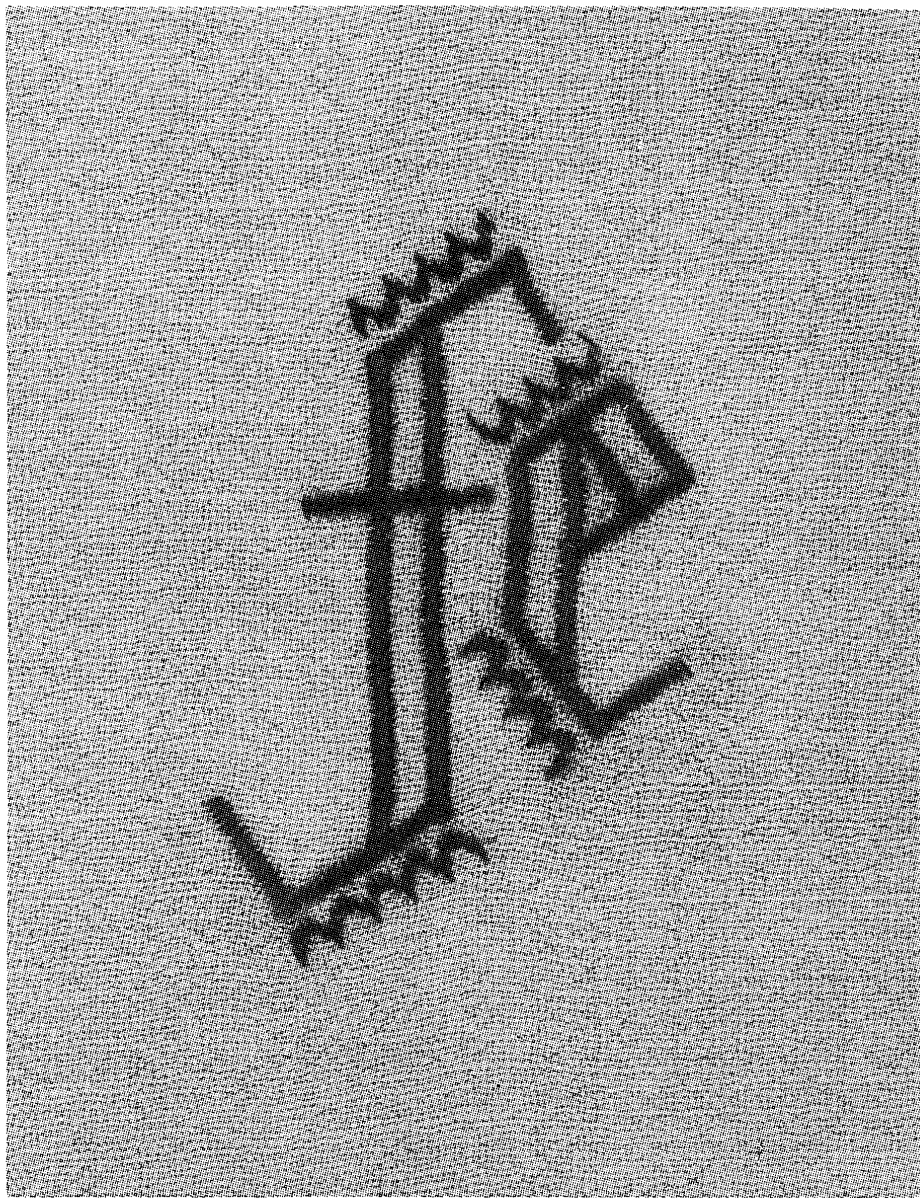

G

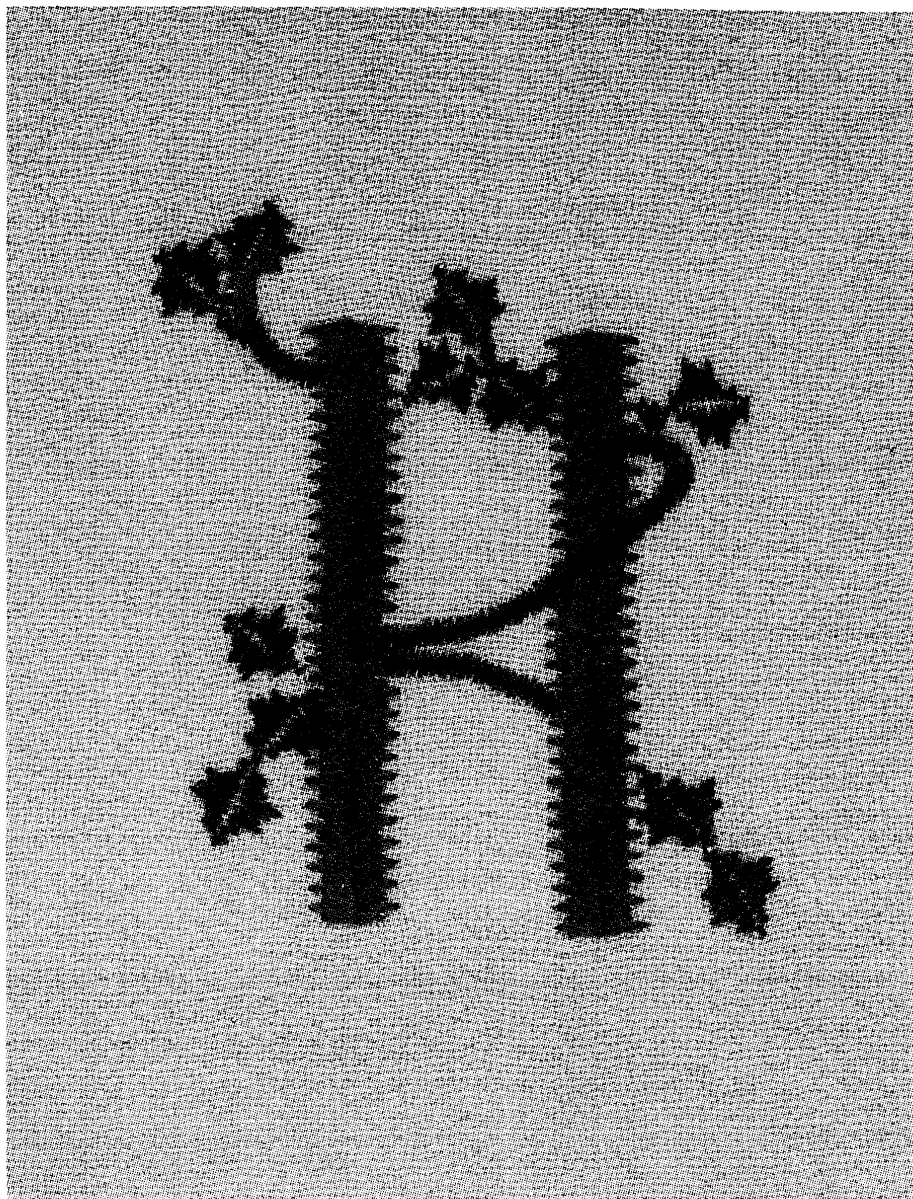
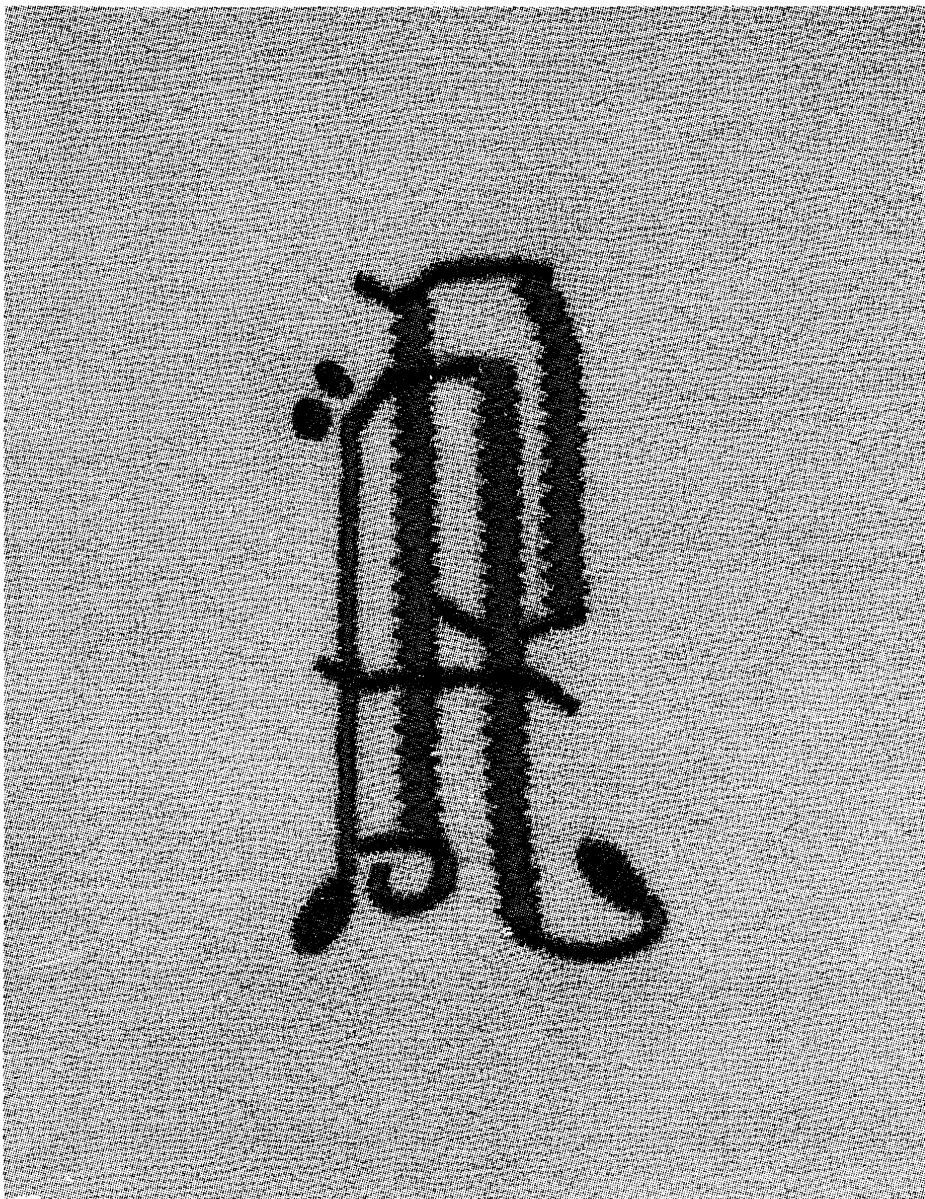

H

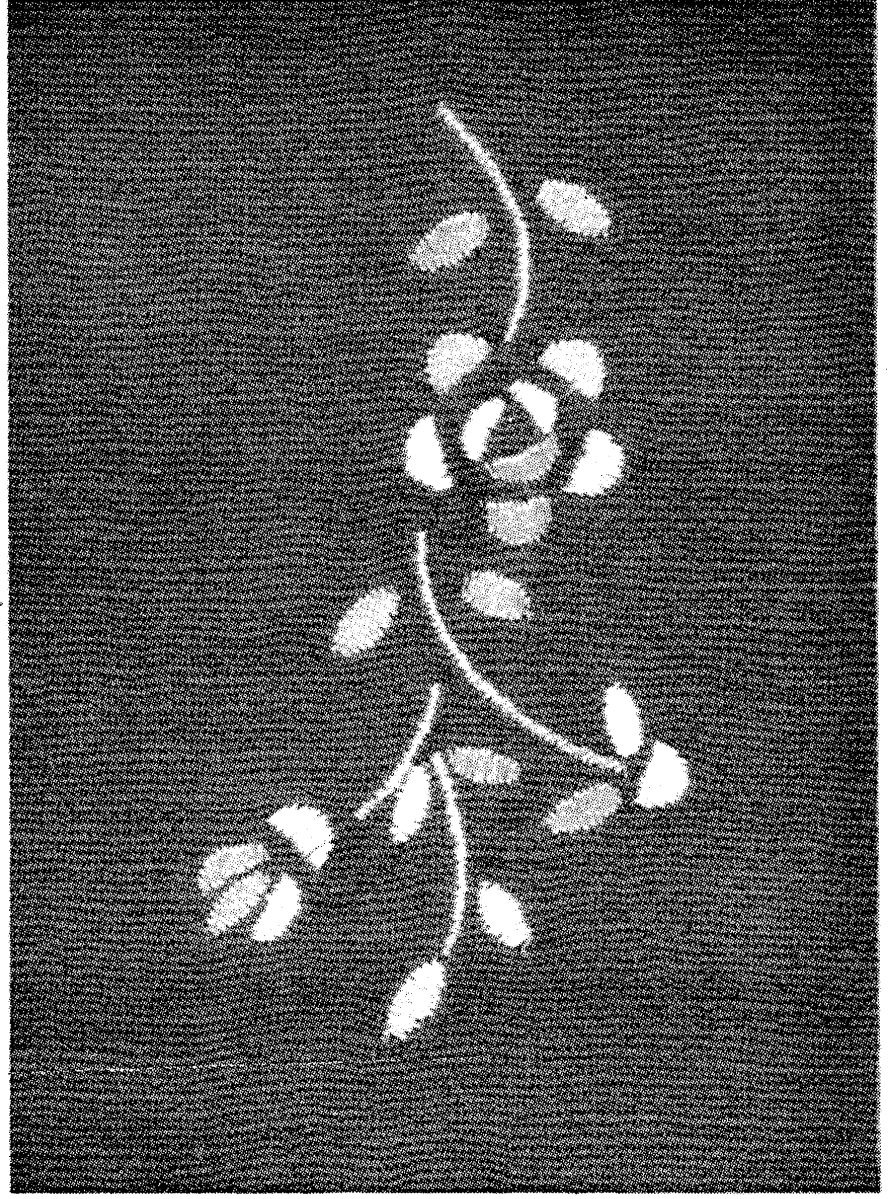
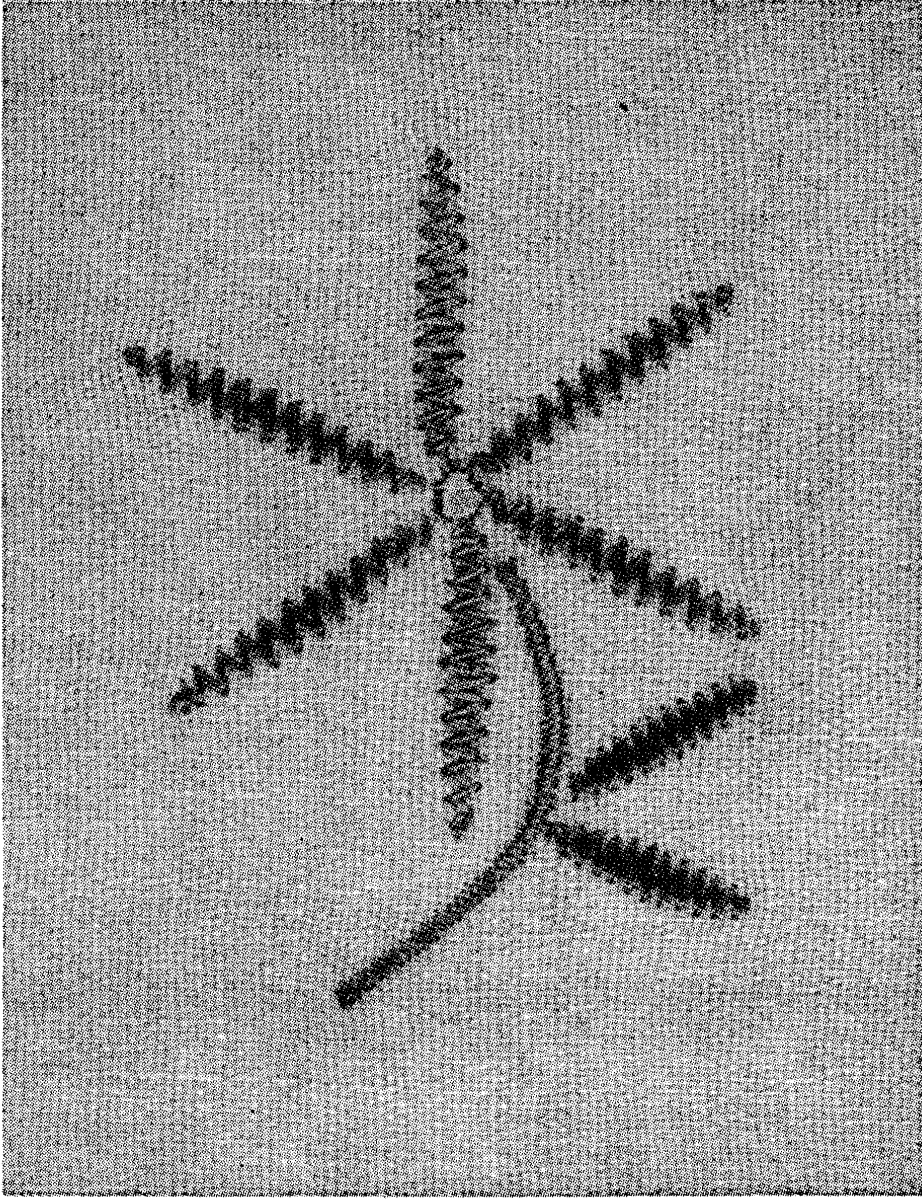

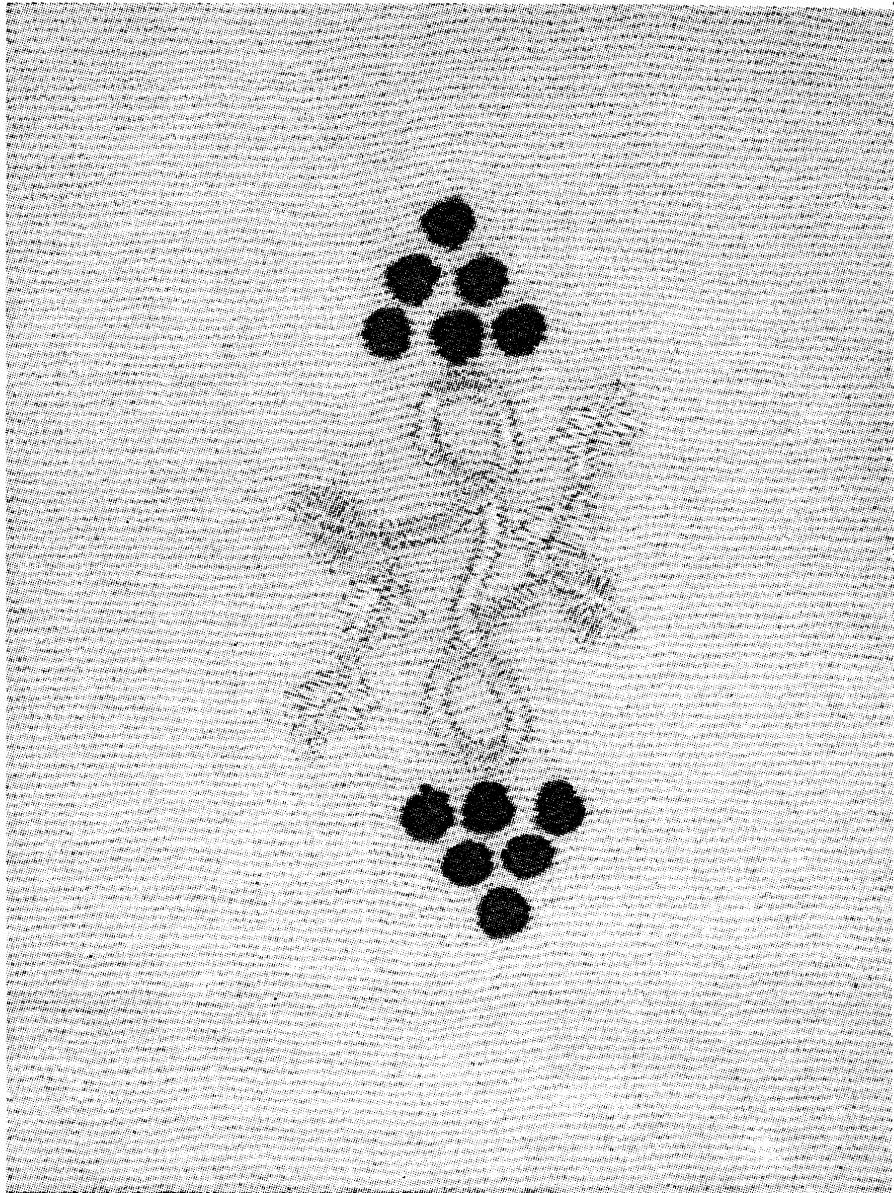
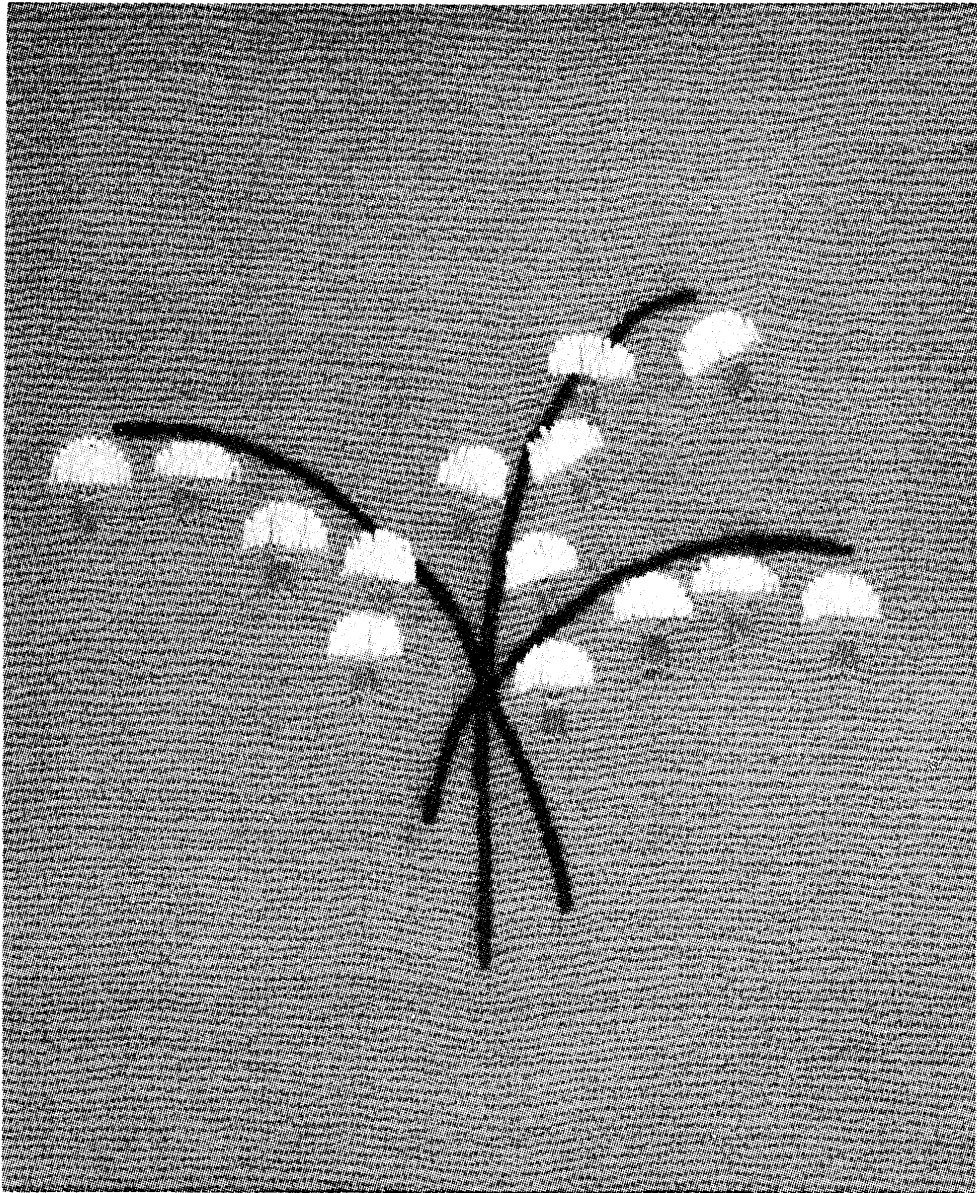

J

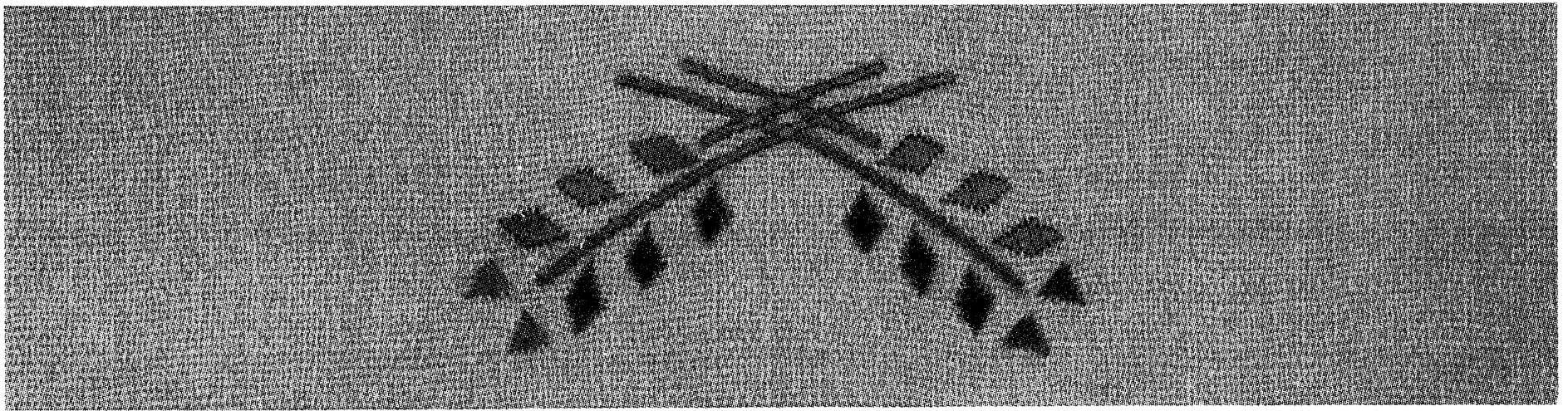
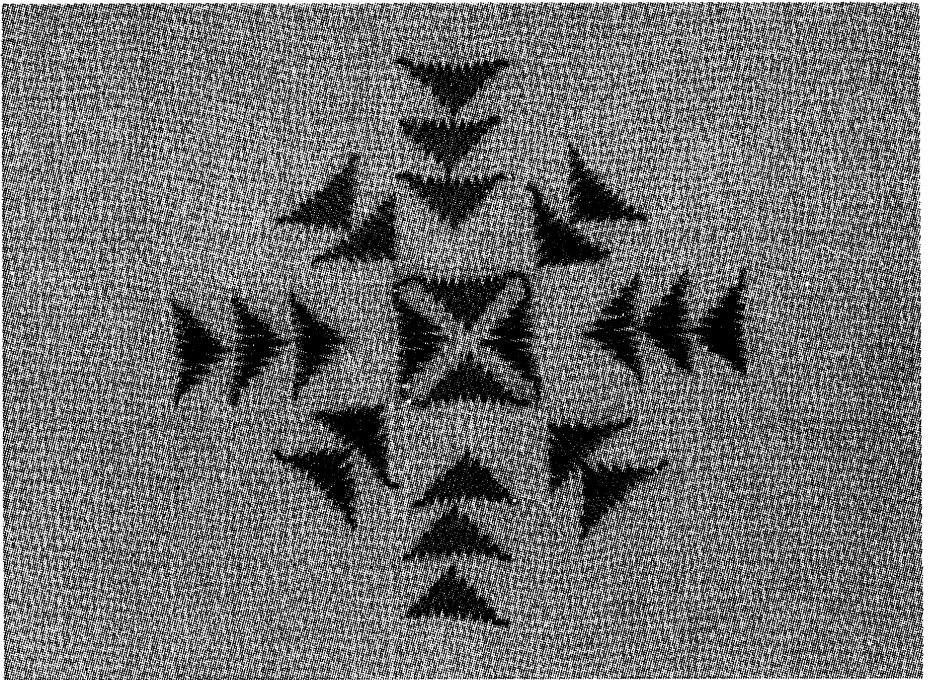
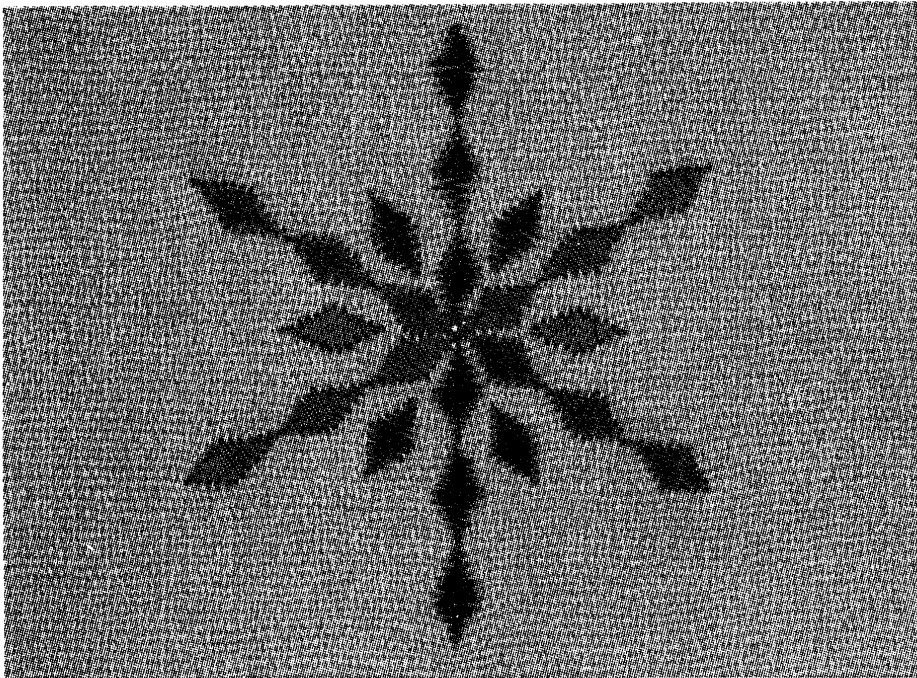

K



L

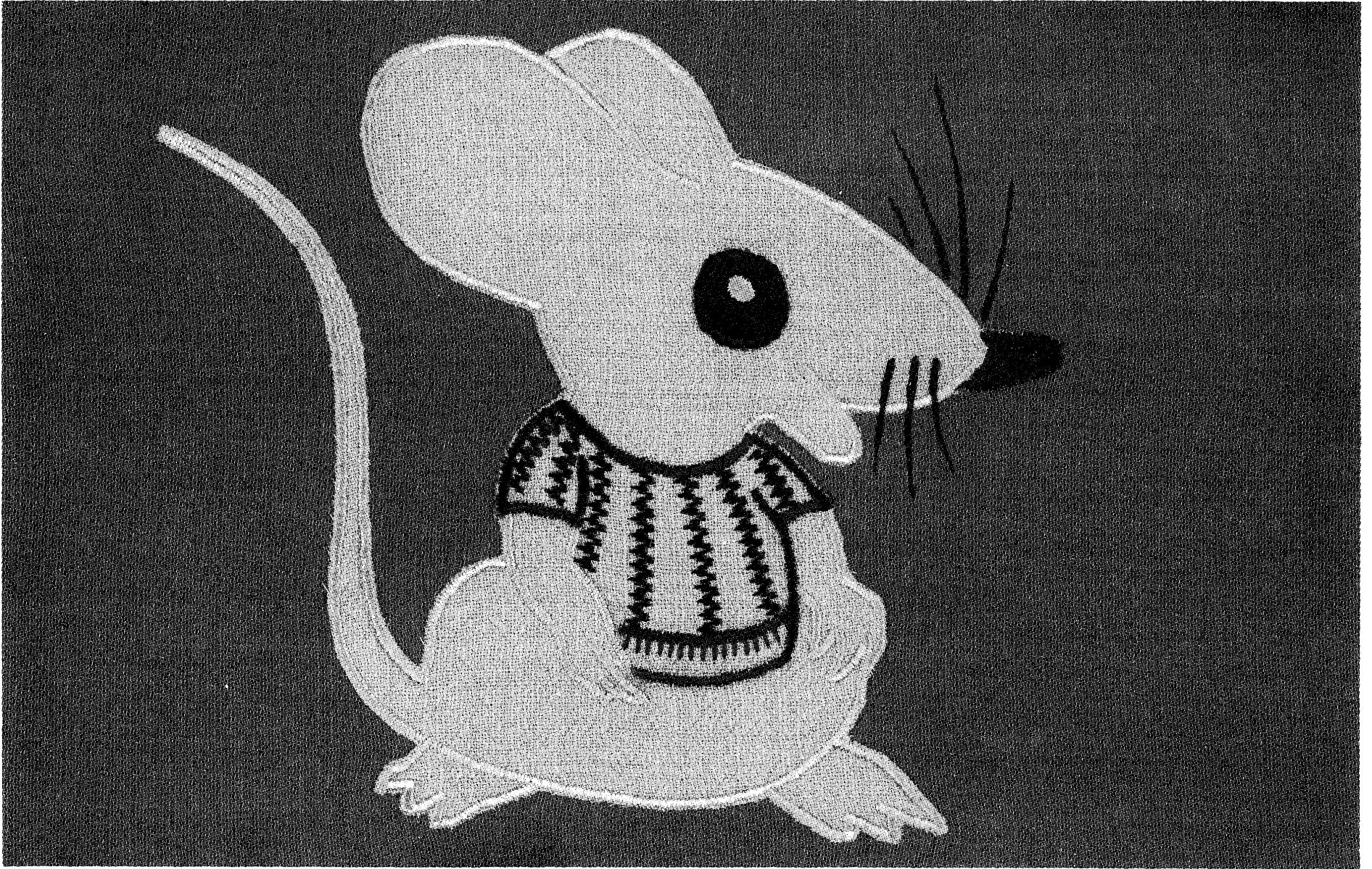

M

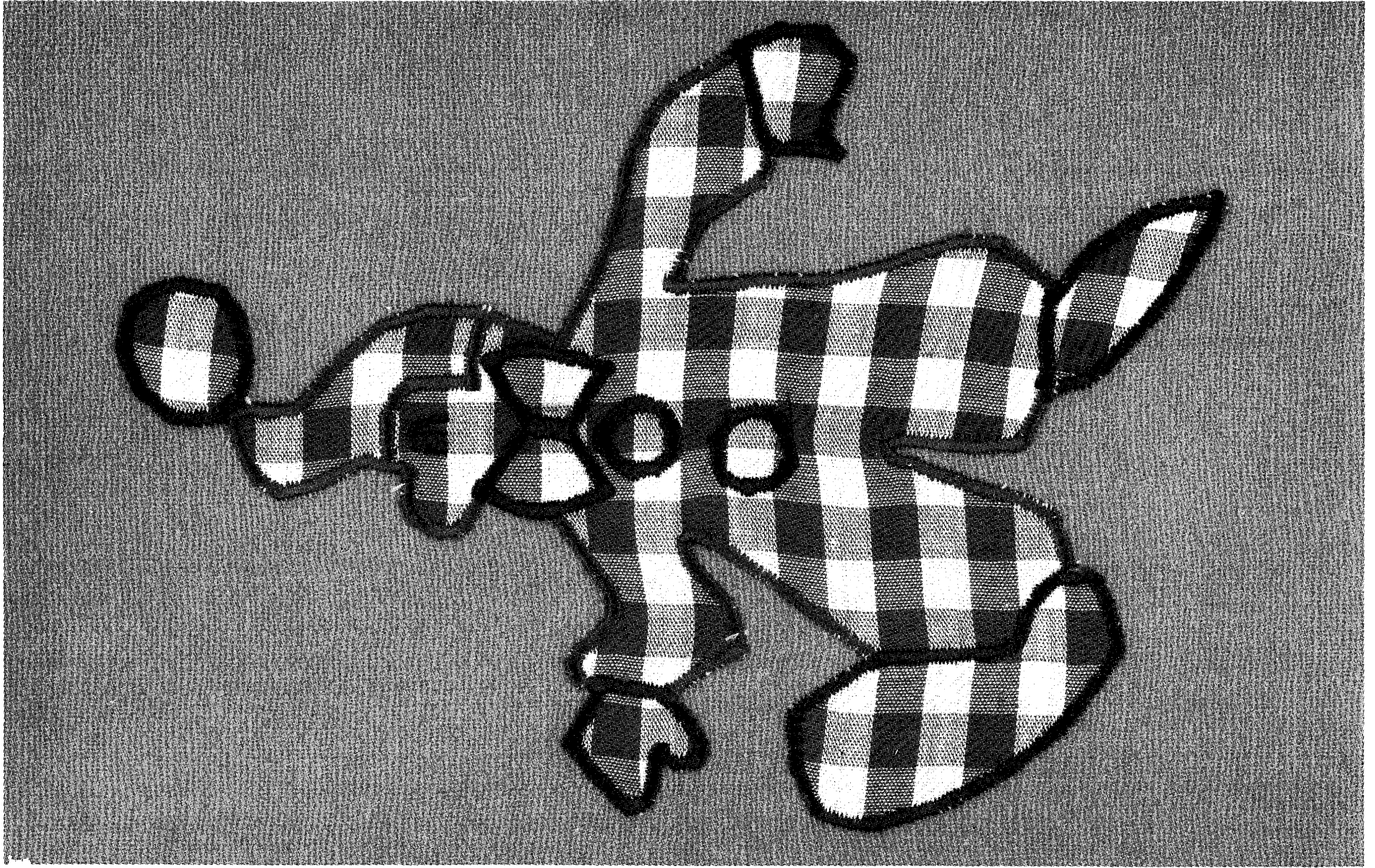

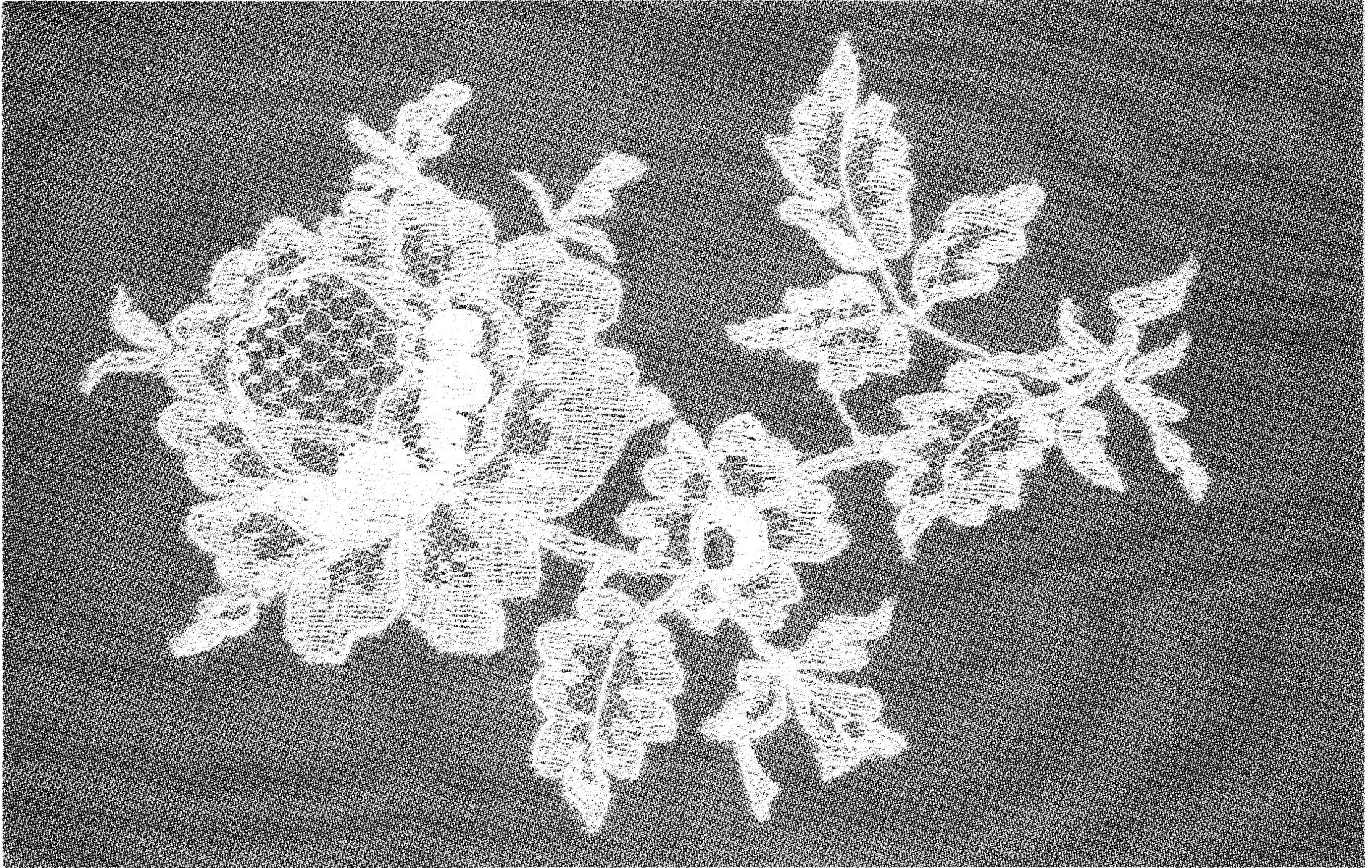



P

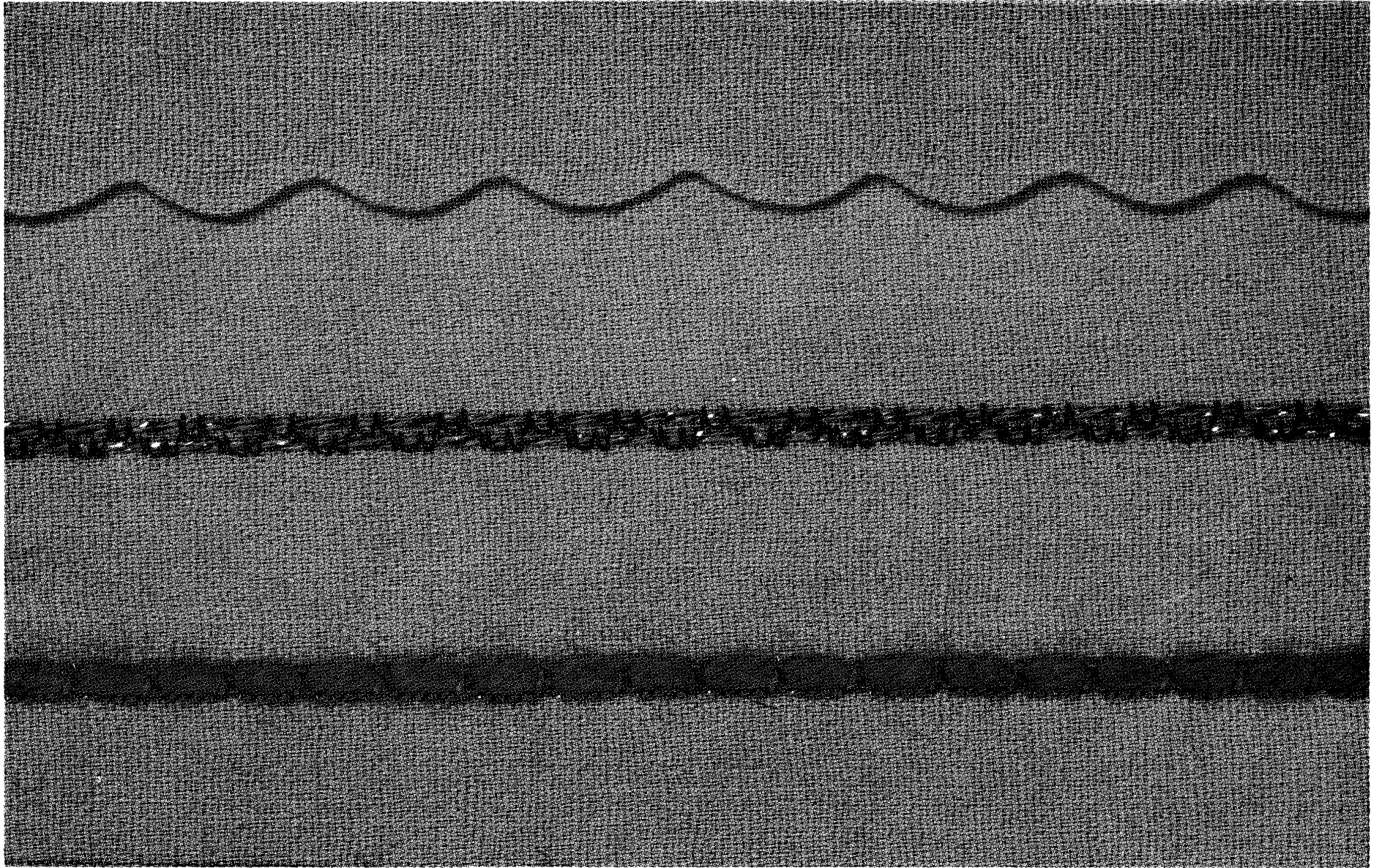

BUTTON SEWING FOOT.

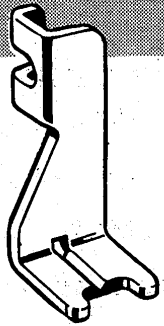

This short, open foot accommodates any size sew-through button, and holds it securely for stitching.

The groove in the foot allows for insertion of a machine needle, over which a thread shank may be formed.

SELECTOR: AL

RED LEVER: 1 AND 4

THROAT PLATE: RAISED

GENERAL PURPOSE

BUTTON SEWING FOOT

The space between the holes in the button determines the Red Lever settings. Numbers one and four generally apply to standard buttons. The number one setting is constant, but four can be increased or decreased to accommodate buttons with unusual spacing.

Set Selector at AL and Red Lever at 1. Raise throat plate. Position button under foot so that needle will enter into left hole. Lower foot. Turn hand wheel toward you until needle rises out of fabric and is just above the foot.

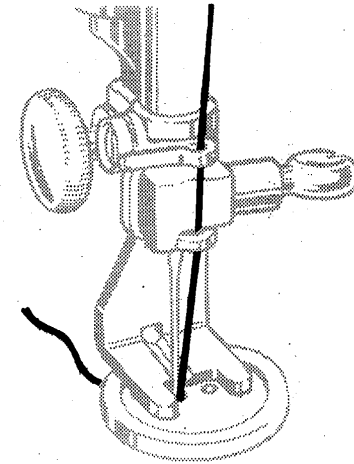
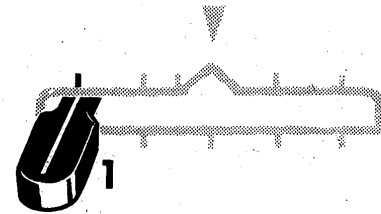

BUTTON SEWING FOOT

Set Red Lever at 4. The needle should then enter into the right hole of the button. Take approximately six zigzag stitches in this position. End on the left side.

To fasten stitching, adjust to number one Red Lever setting and take approximately three stitches.

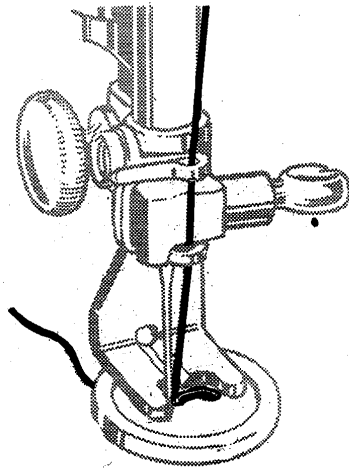
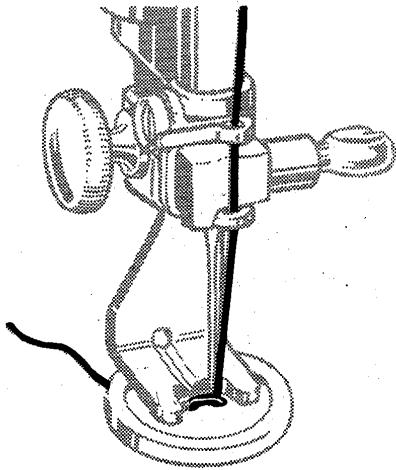

THREAD SHANK

In order to form a shank, stitching is done over a regular machine needle. Position button and lower button foot. Place needle in the groove of the foot so the point enters the hole.

A larger shank results when the heavy end of the needle is utilized.

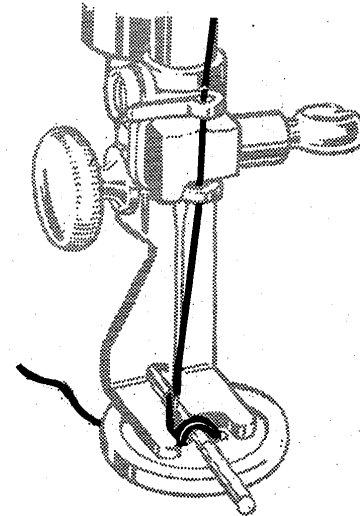

GENERAL PURPOSE FOOT

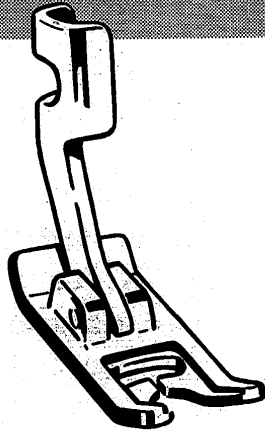

Used with the general purpose throat plate this foot provides a wide needle slot which accommodates all stitch settings and can be used for most sewing operations.

APPLICATIONS

Seams and Darts
Mending and Maintenance

Automatic Scalloping
Seam Finishes

SEAMS

LINGERIE SEAMS

Dainty lingerie seams are made durable and rip-proof with zigzag stitching (BL 2½). After straight stitching the fitted seam on the wrong side, press both seam allowances in the same direction. From the right side, top stitch with a fine zigzag setting, letting the needle enter the seam line and then the seam thickness. Particularly good where flat bias seams are desired.

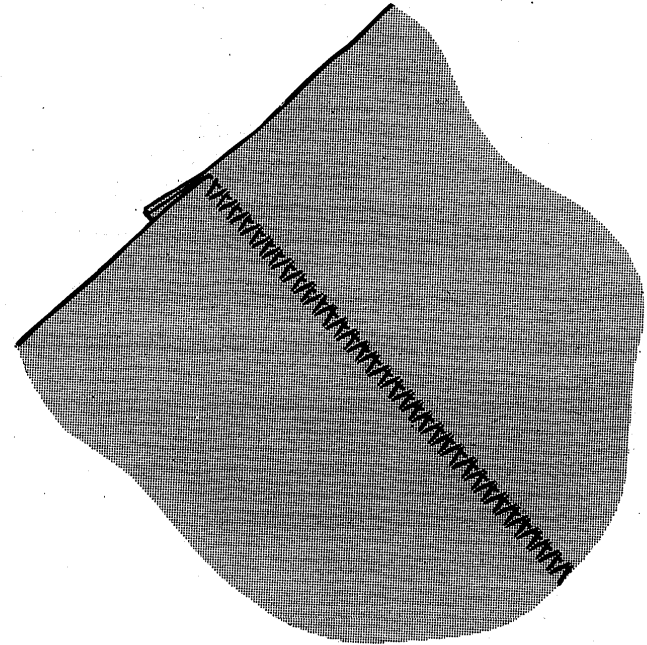

SEAMS

FLAT FELLED SEAMS

Zigzag stitching gives strength and durability to flat felled seams.

Form the seam to the right side of the fabric, taking full seam allowance, using a zigzag stitch (BL 3).

Press the seam open, then fold and press the two edges together, keeping the right side of the zigzag stitch uppermost.

Trim away half the under seam edge.

Fold the upper seam edge evenly over the trimmed seam, and top stitch.

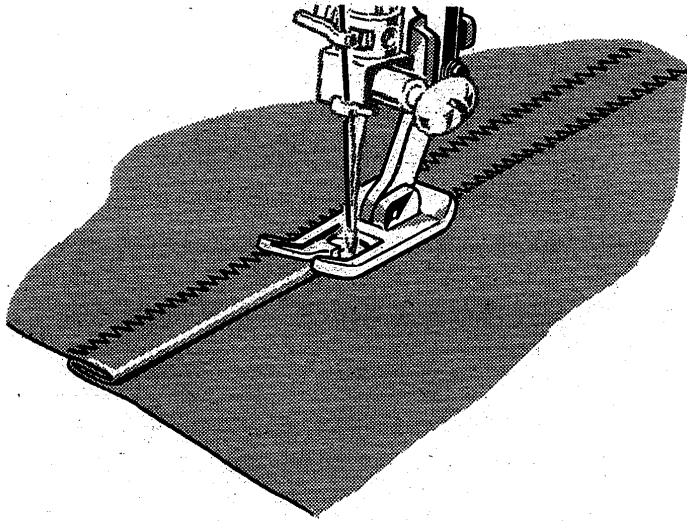

KNIT FABRIC SEAMS

A fine zigzag stitch (BL 1½) is ideal for seaming knit fabrics. Particularly desirable for underarm seams, or other seams where elasticity and give are needed.

For neckline and waistline seams, where a stay is needed to prevent undue stretching, this stitch can be used to apply seam tape. To insure a flat, smooth finish, position the seam tape with the edge exactly on the seam line. If seam is curved, pre-shape tape to fit by steaming, and baste in place.

Stitch, allowing the needle alternately to enter the seam tape and seam line.

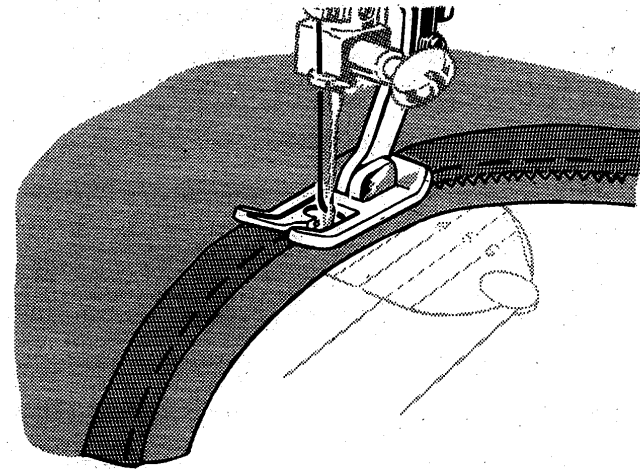

SEAM FINISHES

Seam edges support the garment and should be given a durable finish where fabrics have a tendency to ravel.

The zigzag stitch BL is ideal for such finishing. Place the stitching near the edge of the seam allowance, and then trim away excess fabric.

For an overedged seam, the blind stitch BO makes a durable bulkless finish. Good for straight grain, lengthwise seams.

Seam edges should be trimmed evenly, and the stitch then formed over the raw edge.

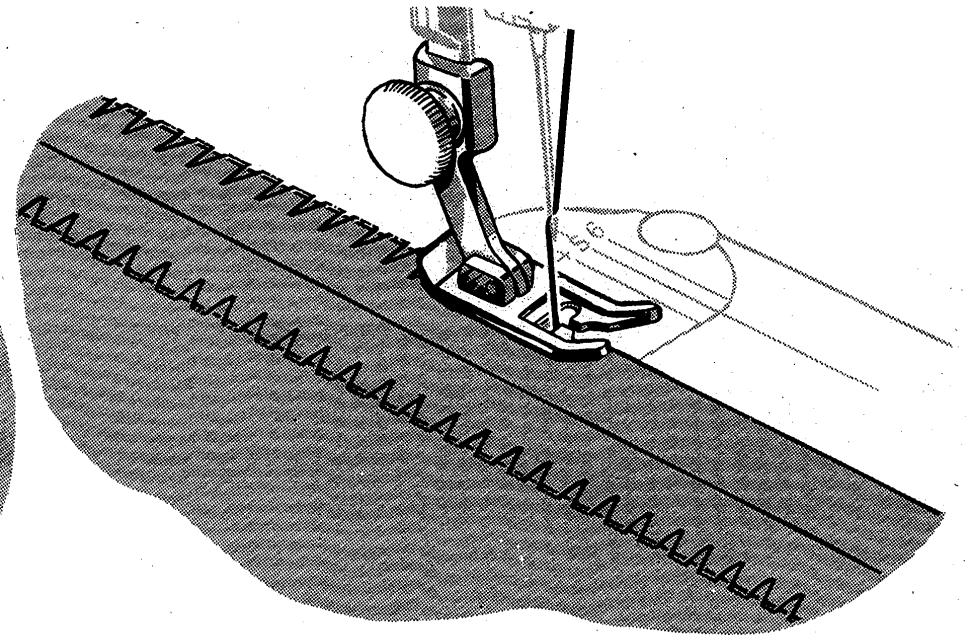
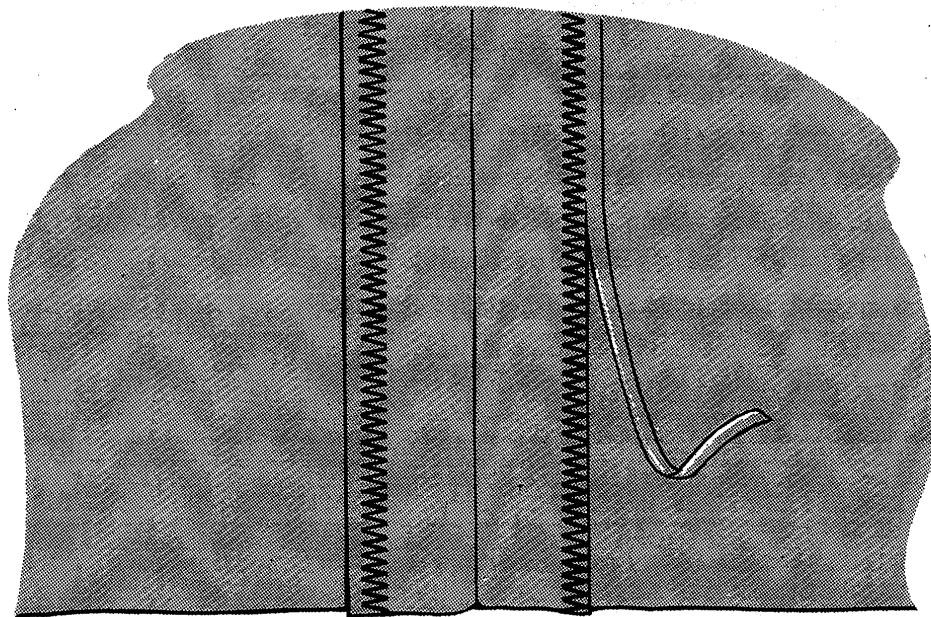

DARTS

Darts provide fit and contour in a garment and should be accurately stitched.

A straight stitch dart (AK 3) is usually formed by stitching from the seam edge, tapering gradually to the point, where the last 3 or 4 stitches parallel the fold. Stitch beyond the fabric to form a thread chain $\frac{1}{2}$ to $\frac{3}{4}$ inch in length. Tie the thread ends into a single knot close to the stitching.

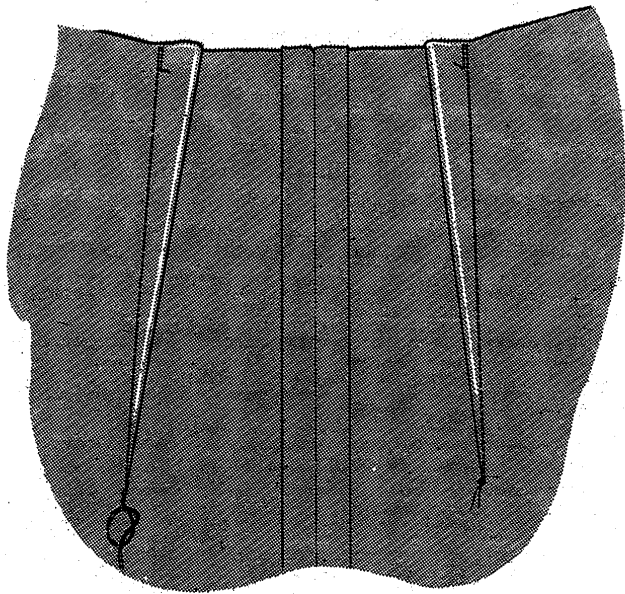

SINGLE THREAD DARTS

Darts add styling and interest when stitched with the fold to the outside of garment. Thread ends at the point of the dart are eliminated when the single thread principle is employed.

Unthread the needle. Use the thread leading off the bobbin and rethread the needle from back to front. Tie bobbin and upper threads together. Draw bobbin thread up through threading points, winding enough on the spool to complete a single dart. Lower the needle into the very edge of the fold at the point of the dart. Take any slack out of the thread by turning the spool. Lower the presser foot and stitch carefully toward the seam edge.

This method is also ideal for inside darts in sheer fabrics as thread ends are eliminated at the point of the dart.

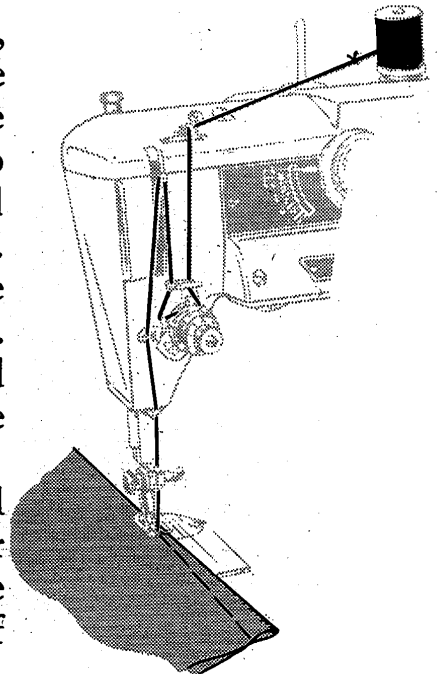

DARTS IN INTERFACING

Non-woven interfacings can be shaped without bulk with zigzag stitching. Selector setting BL or BQ may be used.

Cut out the dart allowance on the stitching line and bring the raw edges together. Pin, over a muslin stay, and stitch. Back stitch at both ends.

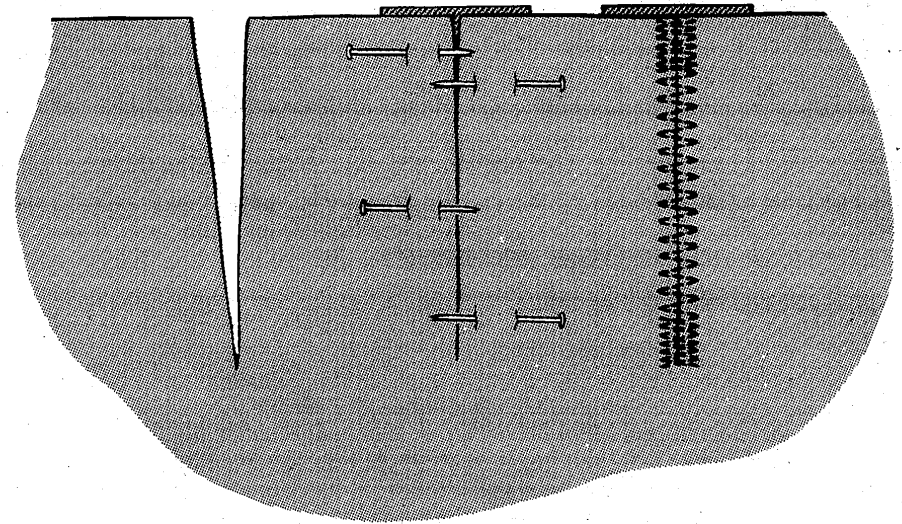

BLANKET BINDING

The multiple stitch zigzag (BQ) is an excellent stitch for applying blanket bindings and affords both a decorative and durable finish. Remove worn binding. Baste new binding securely in place and stitch. Adjust pressure if necessary, to accommodate the thickness of the blanket.

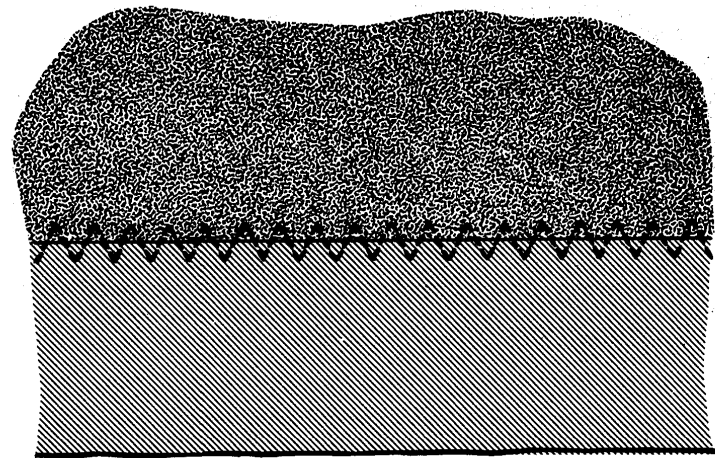

MENDING

Zigzag stitching is well suited for all types of household mending. Selector setting BQ provides a firm, flexible bond for the repair of rents and tears, and is ideal for the reinforcement and application of elastic. Stitch length and width are regulated according to need.

Rent or Tear. Trim away ragged edges. Place an underlay to the wrong side of the tear for reinforcement. Using the multiple stitch zigzag (BQ) follow the line of the tear bringing the edges together. Shorten the stitch length at ends and corners to give extra strength.

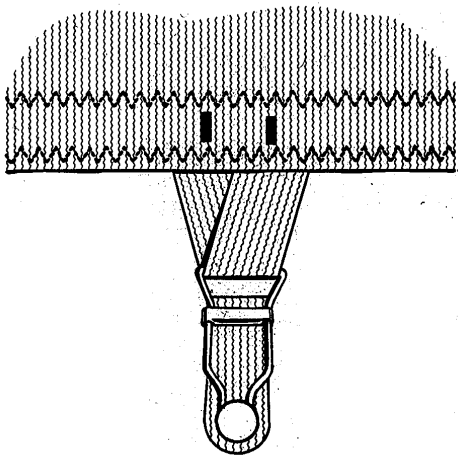

Application of Elastic. Elastic, such as used in waist bands, must be stretched as it is applied, to insure fullness required in the garment.

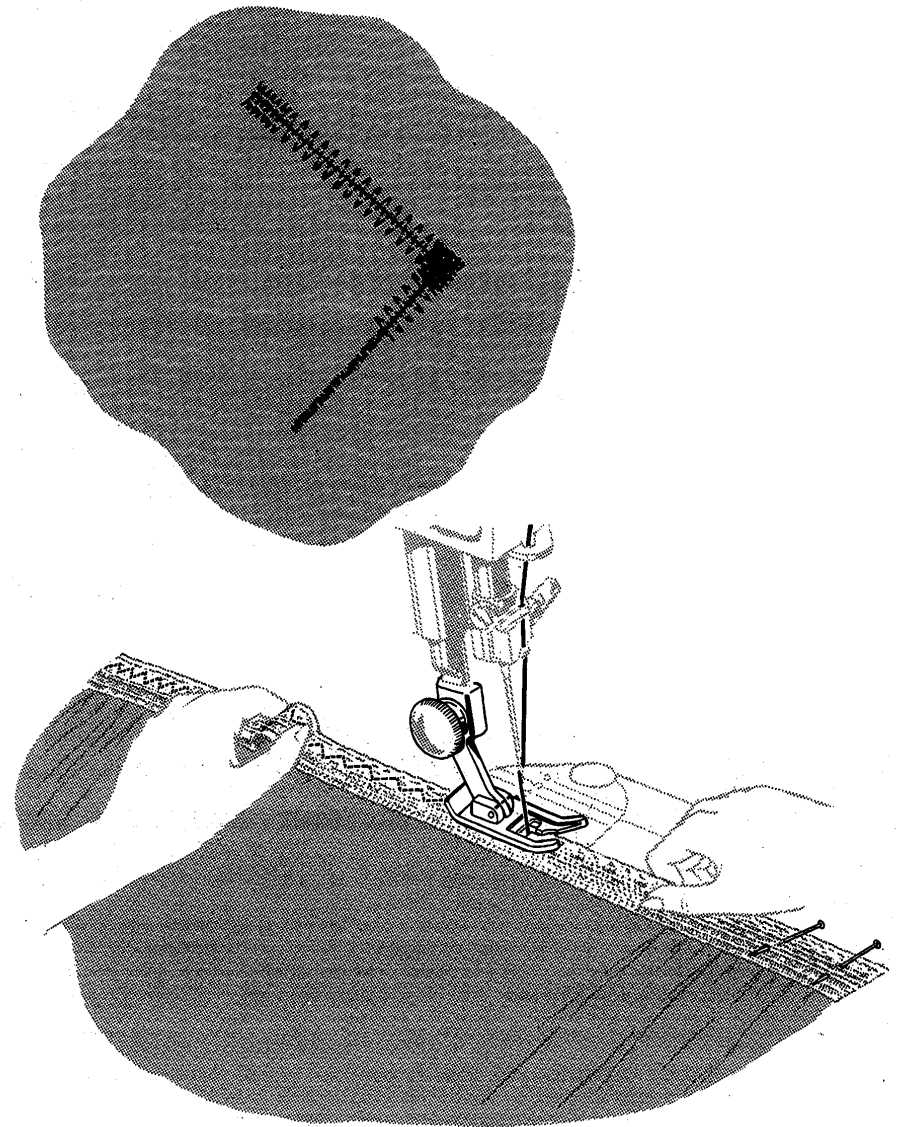

SCALLOPING

Dainty scalloped edges are used extensively as self trimming on blouses, dresses, lingerie and children's wear.

Perfectly formed and evenly spaced scallops are produced automatically at Selector Settings BR and BS ②.

BR results in a 12-stitch scallop.

BS ②, a 24-stitch scallop.

Stitch regulator and Red Lever settings vary the length and depth of the scallop.

After stitching, trim seam allowance to less than $\frac{1}{8}$ " and clip into the points between scallops.

Some fabrics may also need notching, for a smooth, evenly turned edge.

Turn, gently roll out scallops between the fingers and press.

When scalloping a shaped or bias edge it is best to use an interfacing.

When forming scalloped tucks, add an extra $\frac{1}{4}$ " to tuck allowance for seaming.

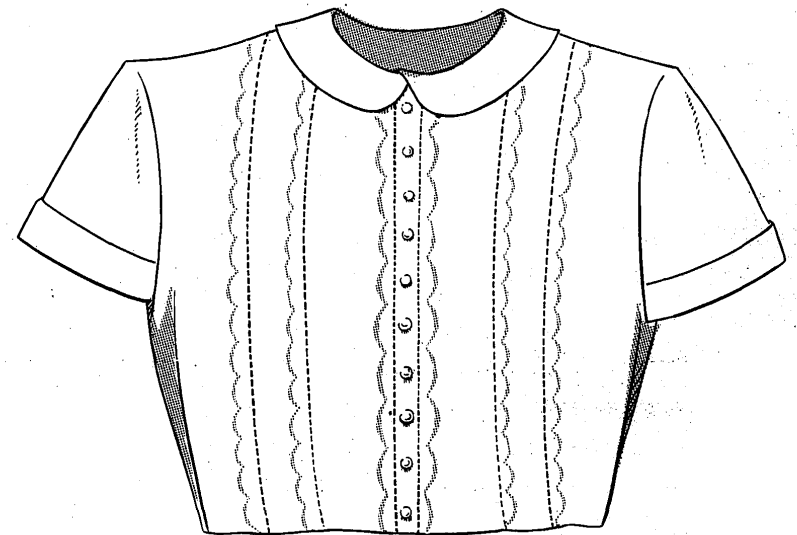
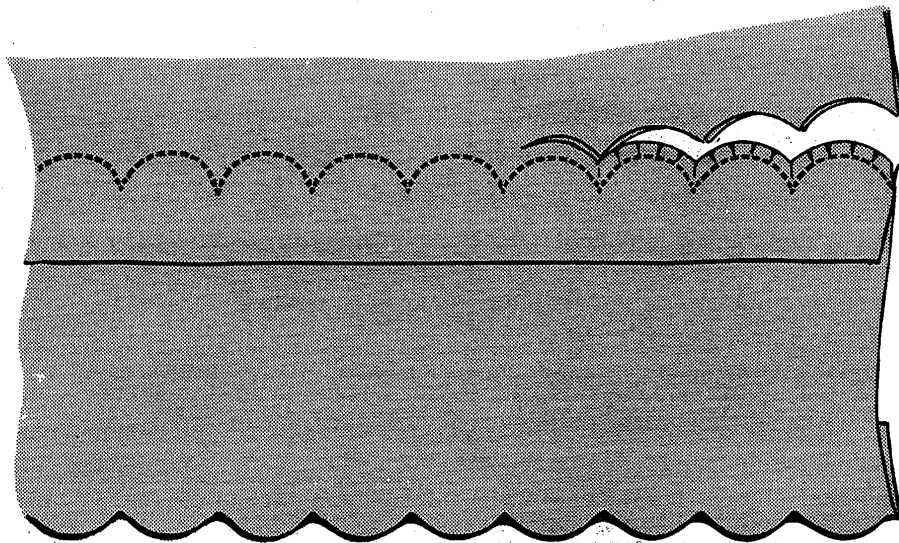

THE SEAM GUIDE

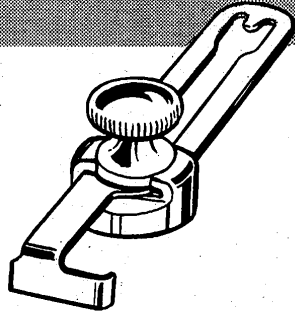

The seam guide aids in attaining uniformity of seam width. It provides for stitching to be spaced at any distance between $\frac{1}{8}$ " to $1\frac{1}{4}$ " from the edge of the fabric.

APPLICATIONS

Seams
Top Stitching

Blind Stitching
Decorative Stitching

The attachment is used in connection with a presser foot.

It is secured to the bed of the machine in either of the threaded holes to the right of the needle.

SEAMS

To guide seam stitching straight and parallel to the edge of the fabric, adjust the attachment for proper seam width. Align the guide with the presser foot. (Set Selector at AK, Red Lever at 3.)

Pin seam edges and baste if necessary. Hand basting can be eliminated on easy-to-handle fabrics. Place pins with the points toward the seam edge so they nip into the fabric at the stitching line. The hinged presser foot will ride freely over the points. Guide the fabric edges lightly against the guide while stitching.

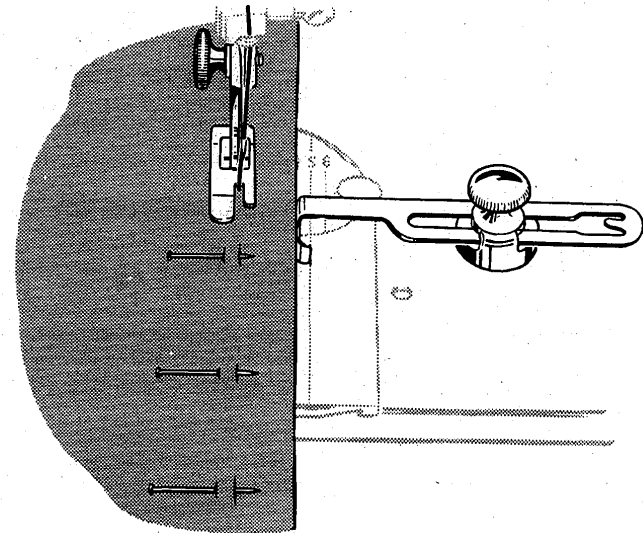

Curved seams require additional treatment in handling. A shorter stitch will provide greater elasticity and strength. Set the attachment at an angle so that the end closest to the needle acts as a guide.

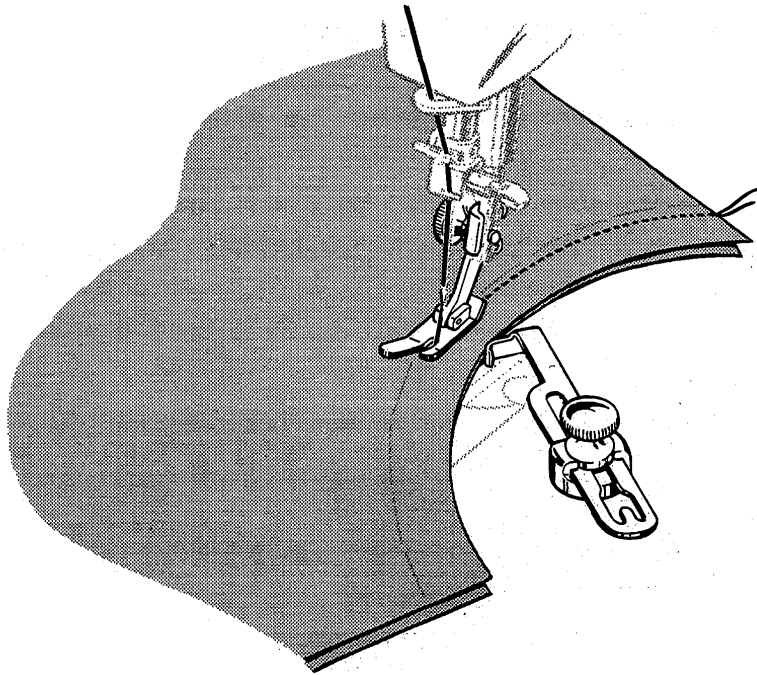

TOP STITCHING

A simple and practical way to accent the lines of a garment and at the same time give additional firmness.

Either single or multiple rows of stitching can be expertly placed along lapels and facing edges, around collars and pockets and as a hem finish.

A subtle effect may be achieved by using straight stitching, or a decorative touch may be added by using any of the attractive stitch patterns accomplished with this machine.

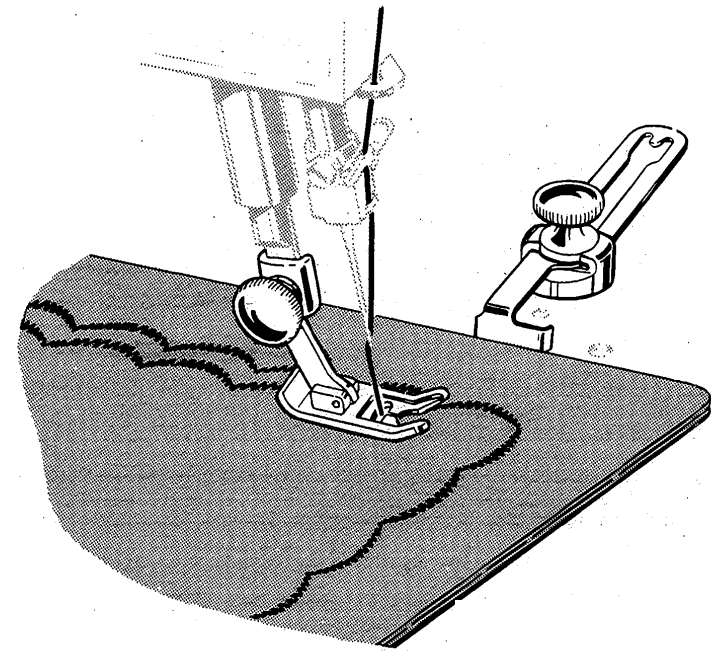

BLIND STITCHED HEMS

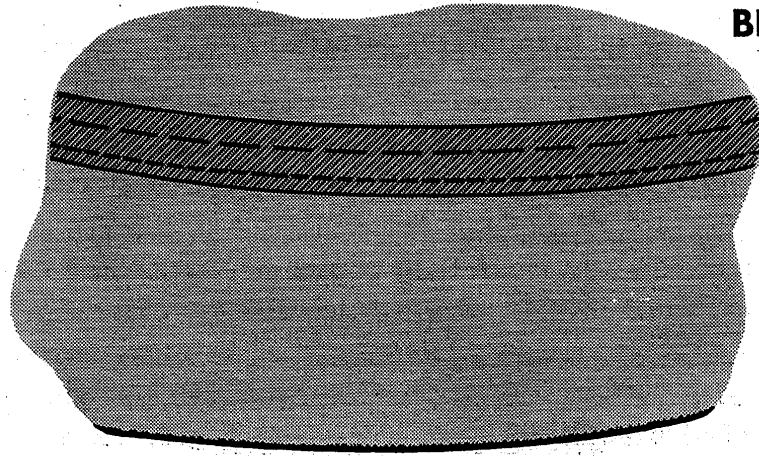

SELECTOR: BO
RED LEVER: 2-5
STITCH LENGTH: 10-20
PRESSER FOOT: GENERAL PURPOSE
THROAT PLATE: GENERAL PURPOSE
SEAM GUIDE

Blind stitching provides a durable hem finish that is almost invisible, and comparable to hand sewing. It is equally suited to straight as well as

circular hems. Taped, bound, turned or unfinished hem edges can all be blind stitched with equal ease.

Mark, turn and press the hem in the usual way. Place a basting guide line approximately $\frac{1}{4}$ " from top hem edge.

Set Selector at BO. This setting produces four straight stitches, separated by a single sideward stitch to the left.

Red Lever setting for width of stitch is determined by the weight and texture of the fabric used.

Place the hem edge over the feed of the machine, turn back the bulk of the fabric to the line of basting, creating a soft fold.

Position the work so that the straight stitches are made on the hem edge and the sideward stitches pierce the fold.

The stitch length will regulate the distance between the blind stitches (10 to 20 stitches per inch).

Adjust the seam guide over the right toe of the foot until it rests next to the soft fold. While stitching, feed the fold against the flat of the guide.

A test sample in self fabric should be made to determine correct settings.

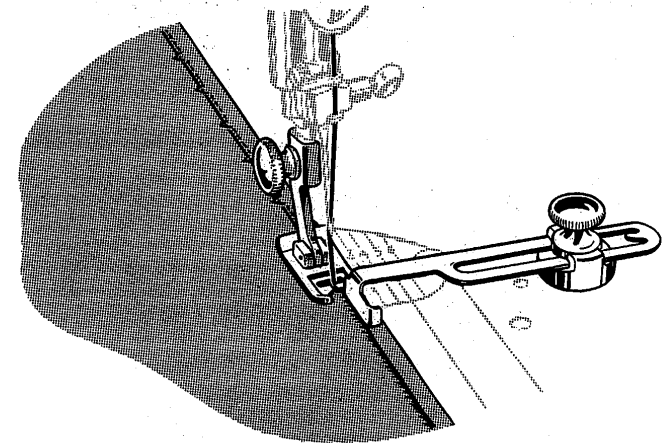

THE ZIPPER FOOT

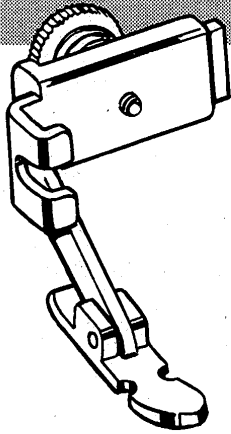

This foot is designed to facilitate the placement of stitching close to a raised edge. The hinged feature of this foot insures even feeding over pins, heavy layers of fabric or cross seams. It is attached to the machine in place of the regular presser foot, and may be adjusted to either the right or left side of the needle. Straight stitch or zigzag settings may be used.

APPLICATIONS

Zipper Insertions
Corded Seams

Tubular Cording
Slip Cover Welting

Preparation. Secure the zipper foot to the presser bar as you would the regular presser foot. Set Selector and Red Lever. Adjustment to the right or left of the needle is made by loosening

the thumb screw at the back. Check the position of the foot by lowering the needle into the side notch, making sure it clears the foot. Lock it into position by tightening the thumb screw.

ZIPPER INSERTION

SELECTOR: AK
RED LEVER: 3
THROAT PLATE: GENERAL PURPOSE
ZIPPER FOOT

Skirt Zipper. Machine baste the placket opening of the skirt and press this seam open. Attach the zipper foot to the machine and position it to the right of the needle. Open the zipper. Place the zipper face down on the seam allowance with the edge of the teeth at the seam line. Turn the back seam allowance away from the body of the skirt. Stitch the zipper tape to the seam allowance.

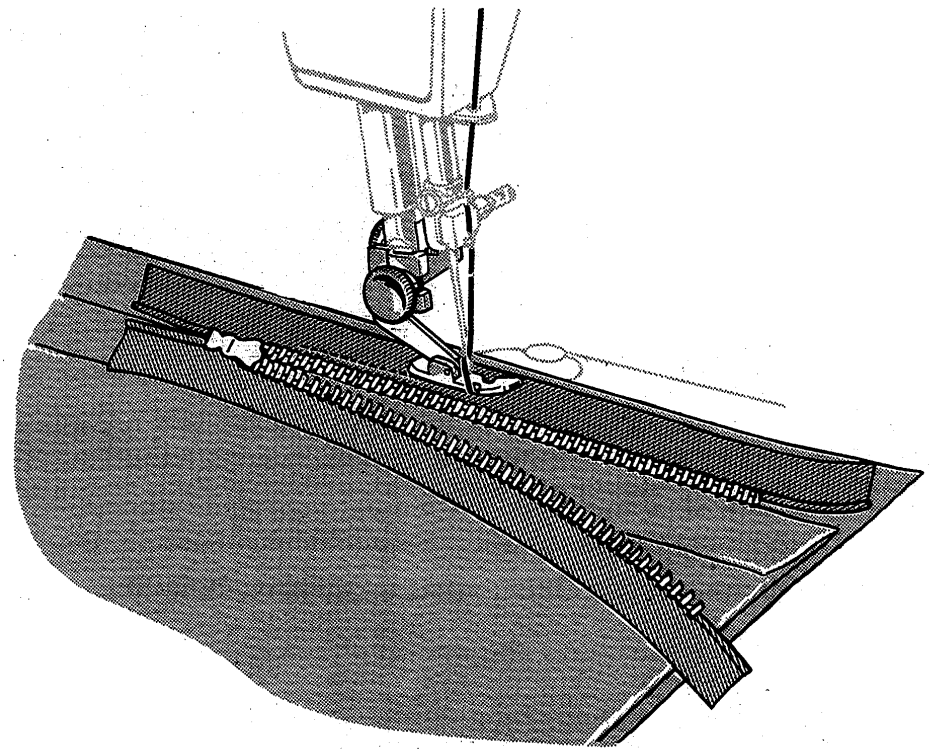

ZIPPER INSERTION

Move the foot to the left. Close the zipper and turn it face up. Smooth back the seam allowance at the edge of the zipper. Top stitch it to the tape close to the folded edge.

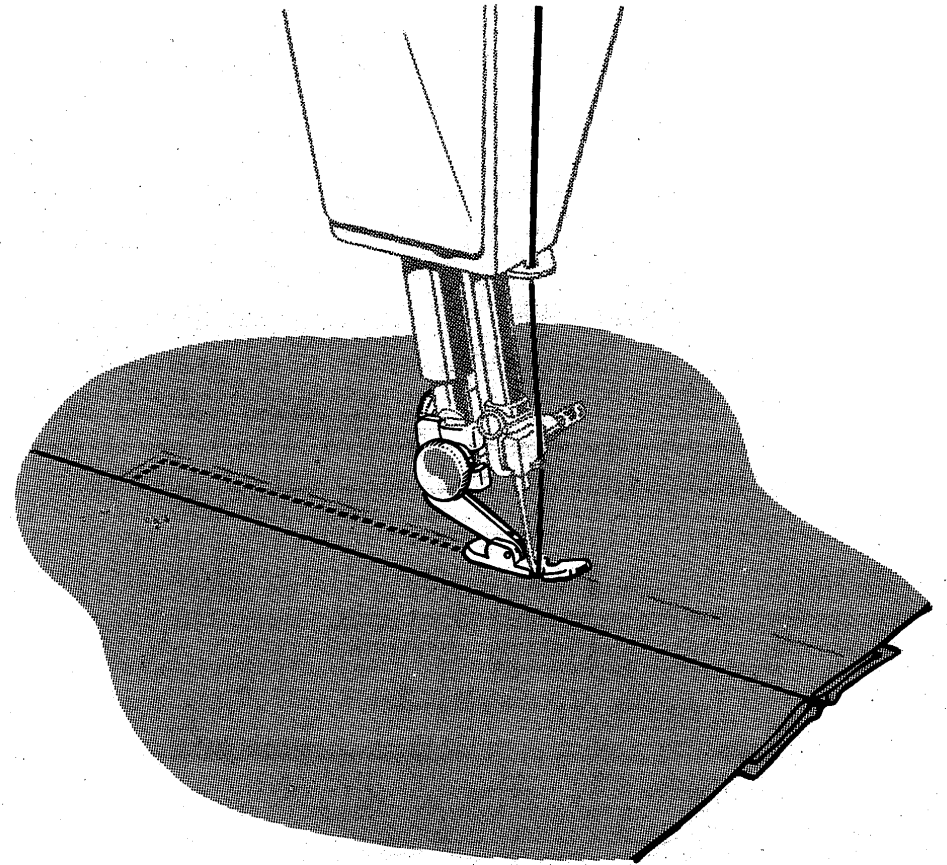
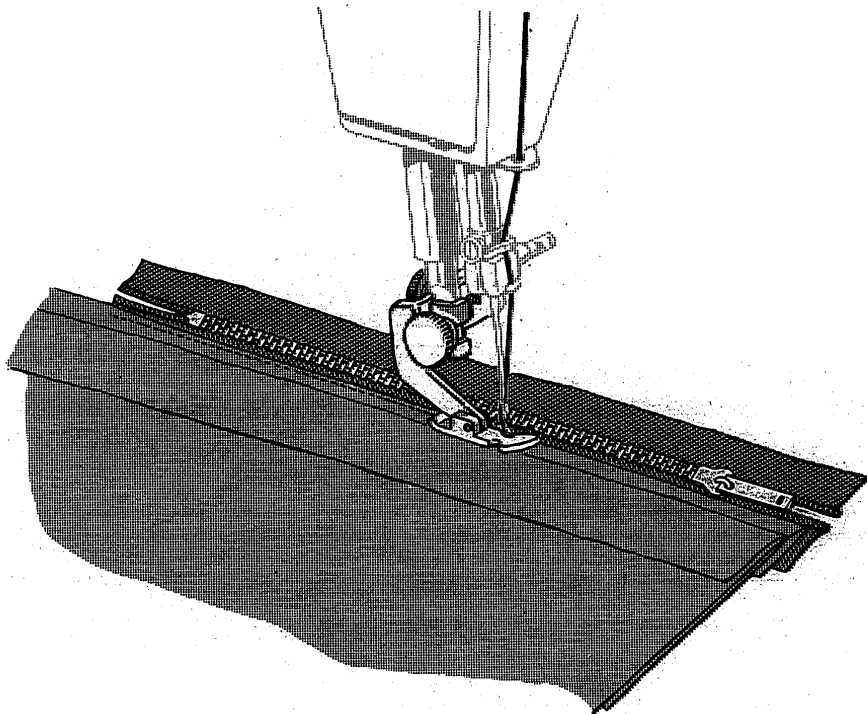

Turn zipper face down. Turn work to right side and pin in place. Baste. Move the foot to the right. Stitch across the lower end of the zipper and up to the waistline. Remove basting.

BLIND STITCHED ZIPPER INSERTION

Blind stitching the final step of a zipper insertion results in a fine finish that is almost invisible and comparable to hand sewing. Particularly suitable for chiffons, sheers, velvets and all delicate fabrics where top stitching would be too harsh.

Allow a $\frac{7}{8}$ " seam allowance. Start the insertion in the usual way, through steps 1 and 2 (pages 62 and 63) but omit final top stitching.

Work from the right side of the garment and pin the front of the zipper tape into position.

Roll the work over finger to ease fabric and pin through all thicknesses. Baste about $\frac{3}{8}$ " from seam line to provide guide for blind stitching. Remove pins.

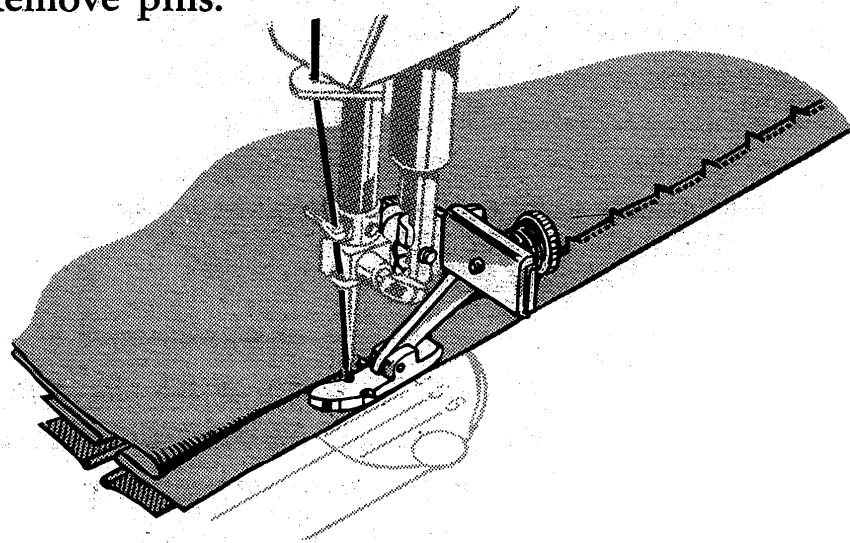

SELECTOR: BO
 RED LEVER: 2½ OR 3
 THROAT PLATE: GENERAL PURPOSE
 STITCH LENGTH: 12
 ZIPPER FOOT

Set stitch and adjust zipper foot to the right side of the needle.

Turn garment inside out. Place zipper tape over feed of machine and turn back the front section of garment to line of basting, creating a soft fold. Position work so that the straight line of stitching is made through front seam allowance and zipper tape, and the sideward stitch pierces a few threads of the fold. Lower presser bar and stitch slowly. Remove bastings. Press.

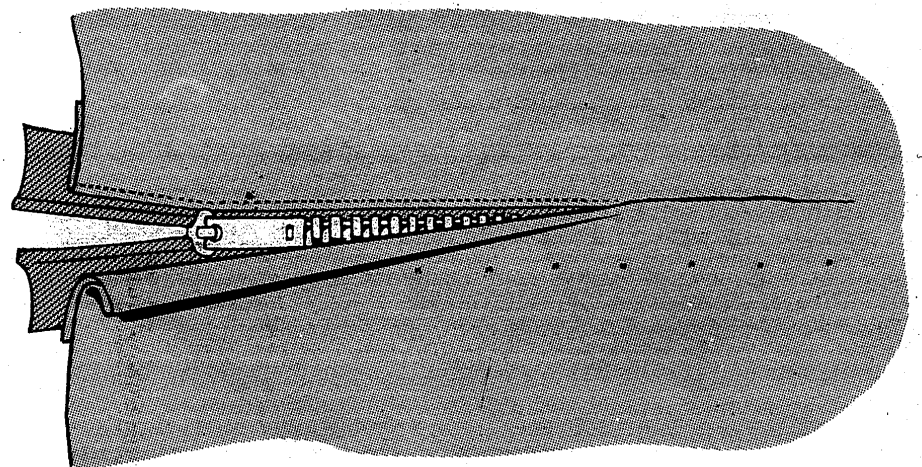

CORDED WELTING

SELECTOR: AK

RED LEVER: 3

THROAT PLATE: GENERAL PURPOSE OR
STRAIGHT STITCH

ZIPPER FOOT

Cable cord comes in a variety of sizes and when covered with a firmly woven fabric makes a corded welting that is an excellent seam finish.

This welting is prepared in advance and then stitched into the seam. Cut a true bias strip $1\frac{1}{4}$ inches wide, plus three times the width of the cord of either self or contrasting fabric. Sew strips together on the lengthwise grain to obtain desired length.

Set Selector. Adjust zipper foot to the left side of the needle. Encase the cord in the bias strip, raw edges even. Lower presser bar. Stitch close to the cord, using a stitch length slightly longer than for seaming the weight of fabric being used. Do not crowd the stitching against the cord.

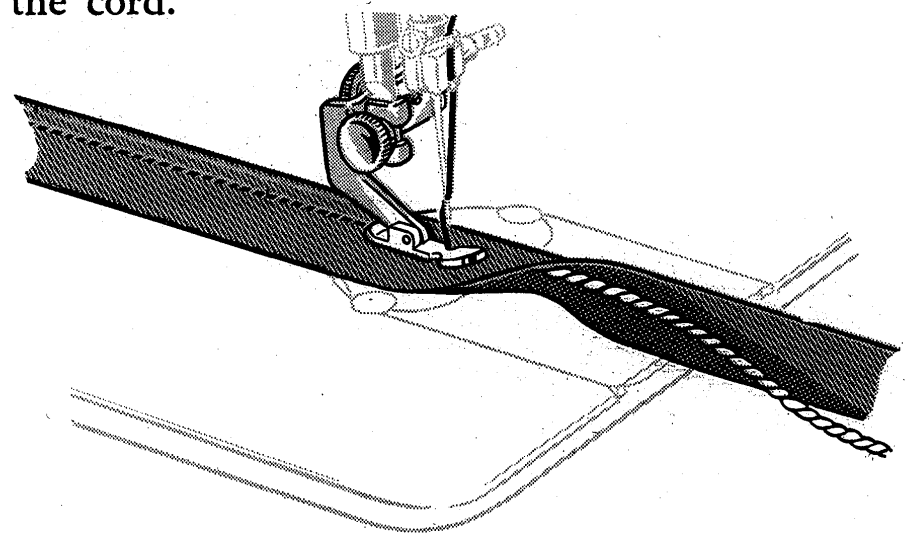
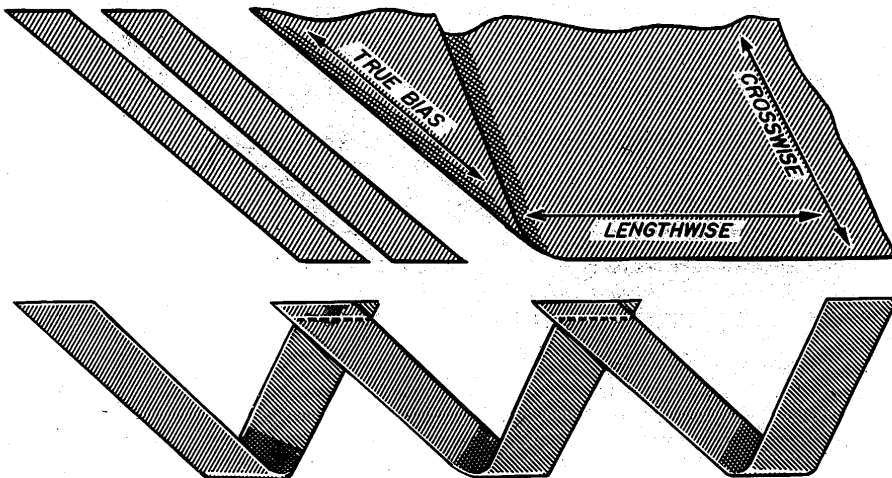

CORDED SEAMS

SELECTOR: AK

RED LEVER: 3

THROAT PLATE: GENERAL PURPOSE OR
STRAIGHT STITCH

ZIPPER FOOT

The corded seam is a typical treatment for slip covers, children's clothes, blouses and lingerie.

When cording a seam the zipper foot is usually adjusted to the right of the needle so that the bulk of the work will fall to the left.

Set Selector and Red Lever. Attach the corded welting to the right side of a single seam edge,

with the same stitch length used to make the welting (page 65). Guide the edge of the foot next to the cord, but do not crowd.

Place the attached corded welting over the second seam edge, and pin or baste together.

Keep the first stitching uppermost as a guide and position the seam under needle. Stitch, this time crowding the foot against the cord.

This method produces evenly joined seam edges and tightly set welting.

Curved seams are cording as easily as straight seams, except that a shorter stitch length is used. Since the seam allowance of the welting is bias, it is not difficult to shape it to the seam.

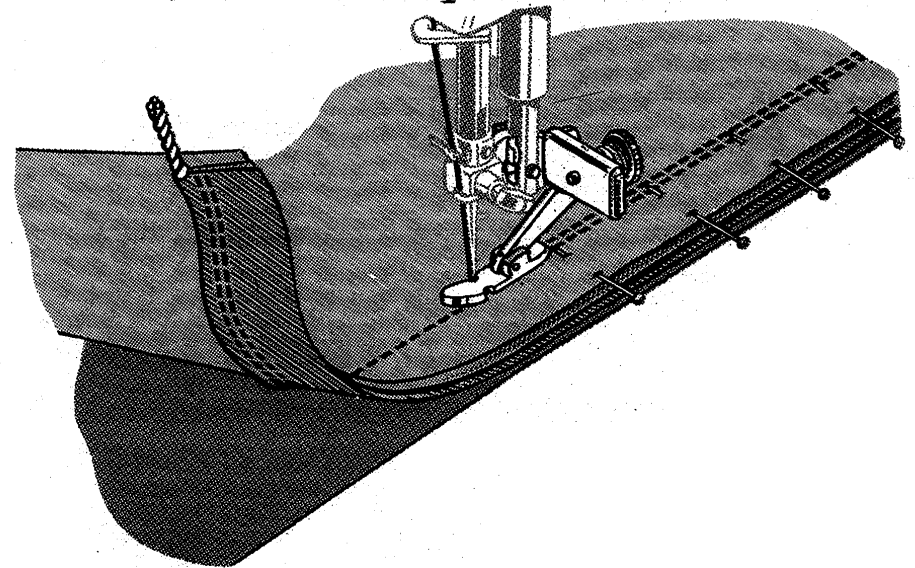
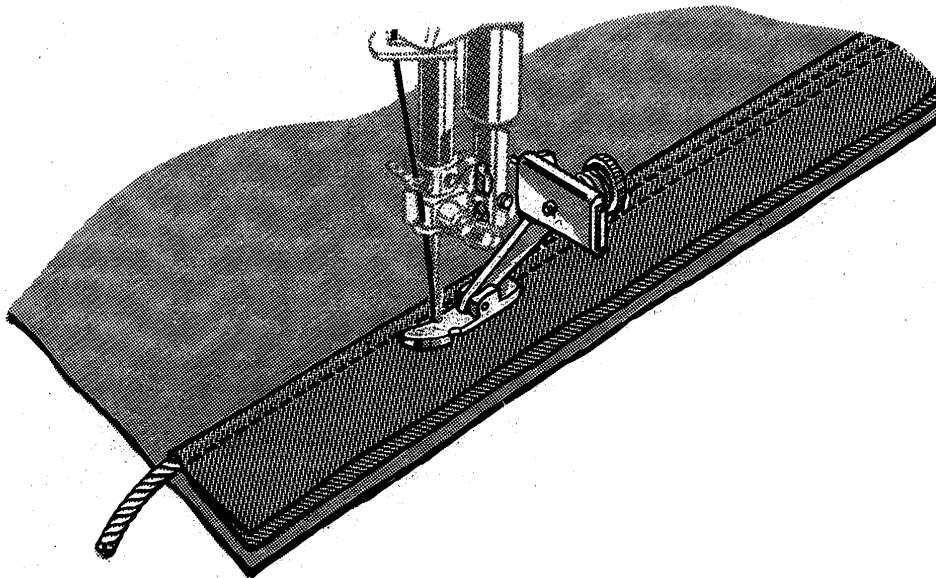

THE FOOT HEMMER

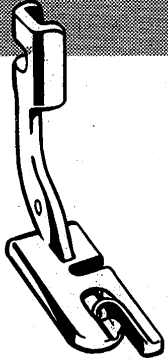

The narrow hemmer forms and stitches a perfectly turned hem without basting or pressing. It is attached to the machine in place of the regular presser foot.

APPLICATIONS

Fine hems
Edging ruffles
Sheer seams

Hemming with lace
Lace insertion
Lingerie finishes

SELECTOR: AK
RED LEVER: 3
THROAT PLATE: GENERAL PURPOSE
FOOT HEMMER

HEMMING

Set Selector and Red Lever. At the very edge of the fabric form a double $\frac{1}{8}$ " fold. Crease this fold for about 2". Draw the bobbin and needle

threads under the hemmer. Place the fabric under the foot and stitch through the creased fold for several stitches. Hold the thread ends in the left hand and guide the raw edge in front of the hemmer evenly into the scroll. Sew slowly, still holding thread ends until the hem is well started.

Soft fabrics will enter the scroll best with the foot down; firm, crisp materials with the foot raised.

Even feeding is essential to good hemming. The same width of fabric must be kept in the scroll of the hemmer at all times. A little practice will result in perfectly formed hems.

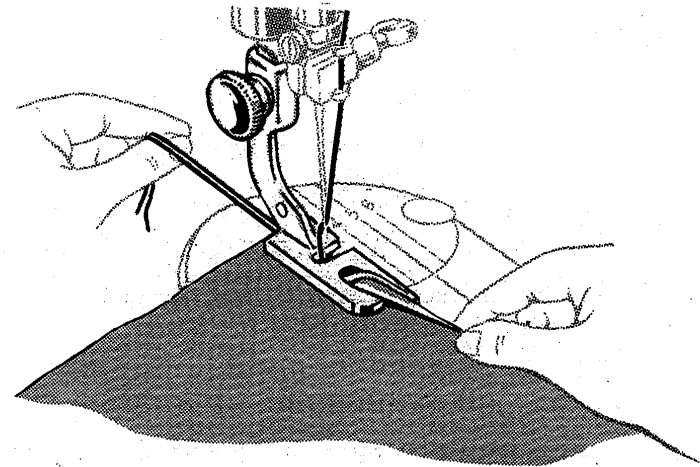

HEMMING WITH LACE

SELECTOR: BL
 RED LEVER: 3
 THROAT PLATE: GENERAL PURPOSE
 FOOT HEMMER

Most of the popular kinds of lace edging and insertion can be applied with the Foot Hemmer. It is an excellent way to trim children's clothes and to finish lingerie hems.

Lace Applied Over Hem. Fold and start the hem in the usual way. Starting about 1" down from the end of the lace, place the selvage under the needle and lower needle to hold lace firmly. Raise the foot slightly and slip the lace under the back portion of the foot, without disturbing the position of the fabric. Stitch slowly, guiding the fabric with the right hand, the lace with the left. Take care not to stretch the lace.

Lace Applied Under Hem. When using lace underneath the fold of a hem, the procedure is the same as when making a hemmed seam. Slip the lace in from the left as you would the second piece of fabric. This method is used where a neat finish is desired on both sides of the material.

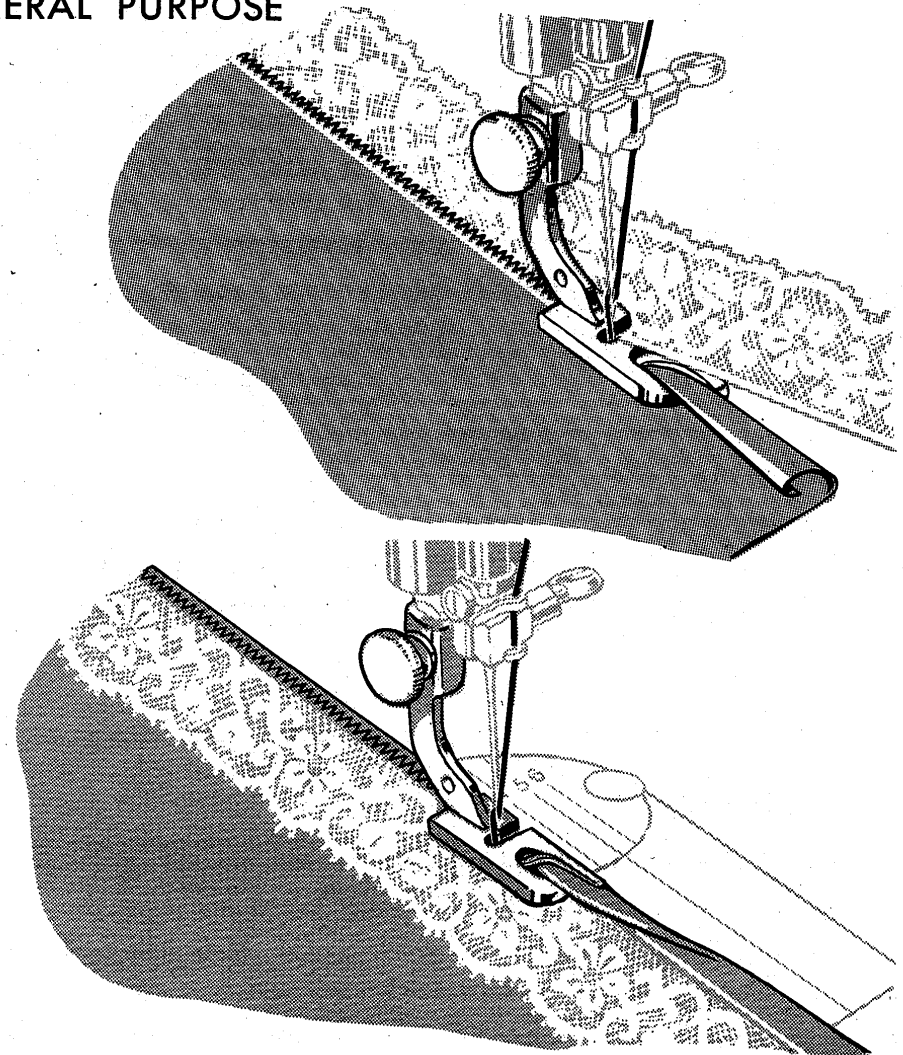

DECORATIVE HEMS

SELECTOR: ALL SETTINGS
THROAT PLATE: GENERAL PURPOSE
RED LEVER: 2 THRU 5
FOOT HEMMER

Narrow hem edges can be turned and decorated in one operation using the foot hemmer and a stitch pattern.

This time-saving finish is especially suited to ruffle edges and aprons.

Lingerie and most delicate fabrics can be attractively finished with a soft shell edge. This effect is obtained by hemming with Selector set at BO or BQ and Red Lever at 4

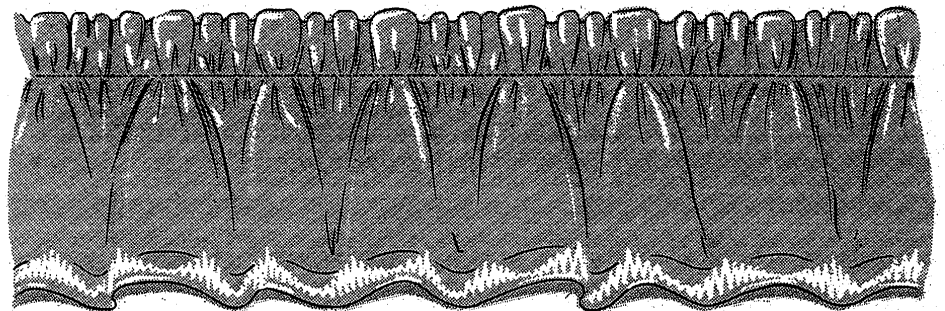
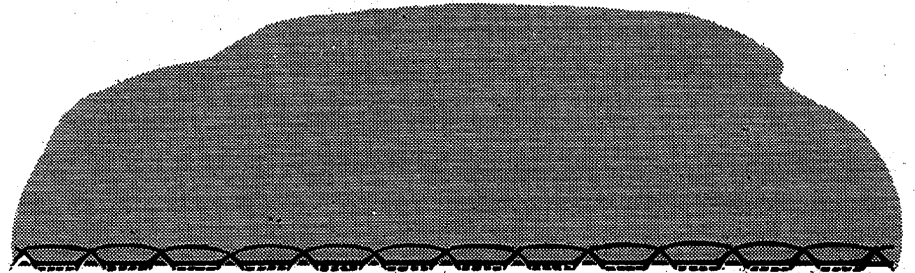
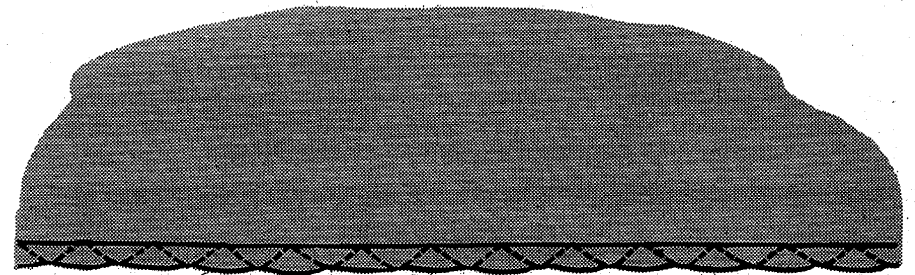
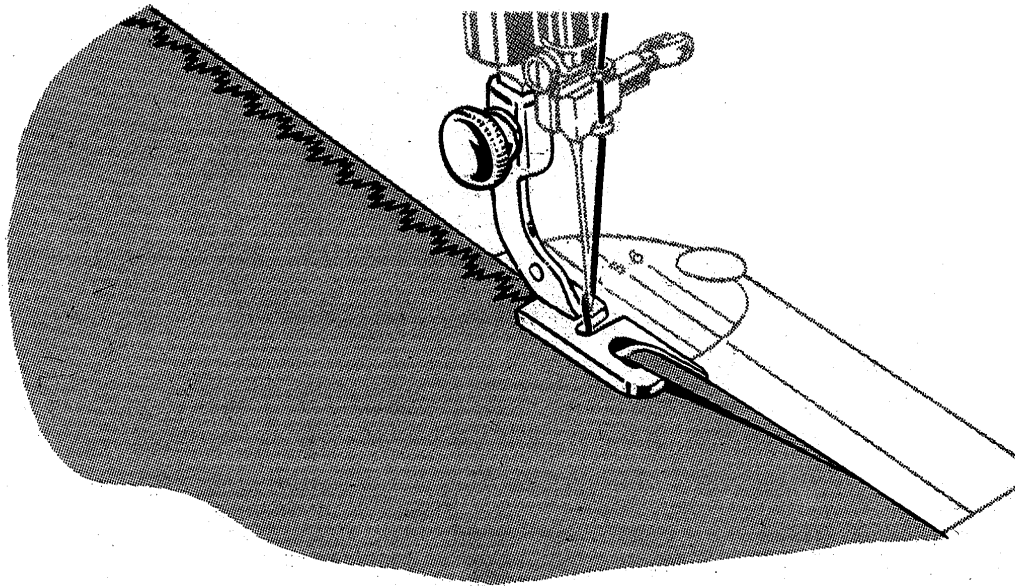

MULTI-SLOTTED BINDER

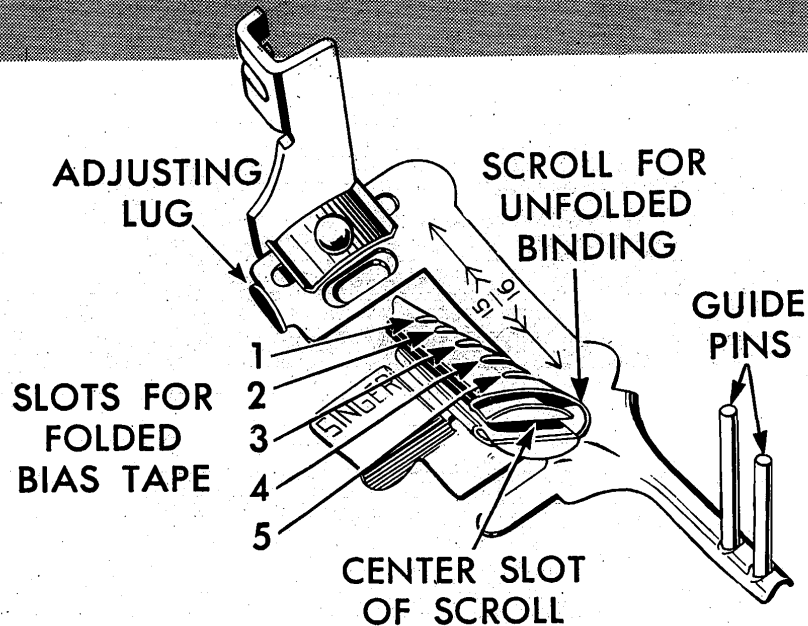

SELECTOR: ALL SETTINGS
 RED LEVER: 2 THRU 5
 THROAT PLATE: GENERAL PURPOSE
 MULTI-SLOTTED BINDER

The multi-slotted binder is used to apply commercial binding as well as self fabric bias to an unfinished edge.

This colorful trim is attractive when applied to children's wear, aprons and fabric furnishings. It is a practical finish for seam edges that ravel and for making bound seams.

The attachment will accommodate both straight and zigzag stitching.

Cut binding diagonally to form a long point. Commercial binding in sizes 1 to 5 is inserted from the right into the appropriate slot in the scroll. Unfolded bias $\frac{1\frac{5}{16}}$ of an inch wide is inserted into the opening at the end of the scroll.

Pull binding through scroll until the evenly folded edges are under the needle. The free length of the binding is held between the guide pins.

Set Selector and Red Lever for either straight or zigzag stitching.

Insert the edge to be bound into the center of the scroll. The stitching is positioned close to the edge of the binding by moving the scroll portion of the attachment to the right or left by means of the adjusting lug.

MULTI-SLOTTED BINDER

Lower the presser bar. Allow the attachment to do the work, merely guiding the fabric into the center of the scroll as you stitch.

Curved edges require slightly different fabric handling than straight edges.

Inside curves are straightened as they are fed into the binder. If the fabric is soft and has a tendency to stretch, reinforce the edge with a single row of stitching before binding.

Outside curves tend to lead away from the center slot of the scroll and should be guided so that a full seam width is taken at the needle point. Do not attempt to pull or straighten fabric into the full length of the scroll.

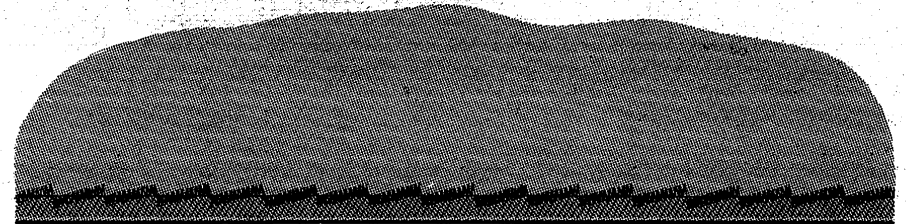
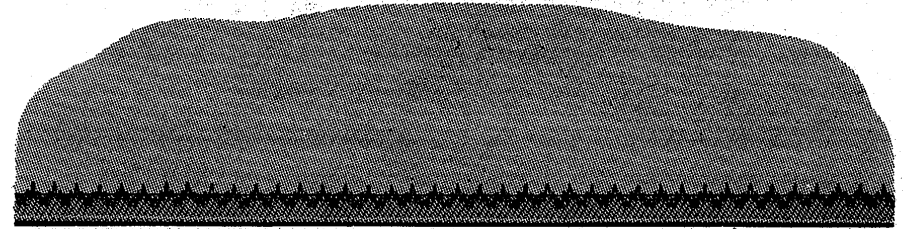
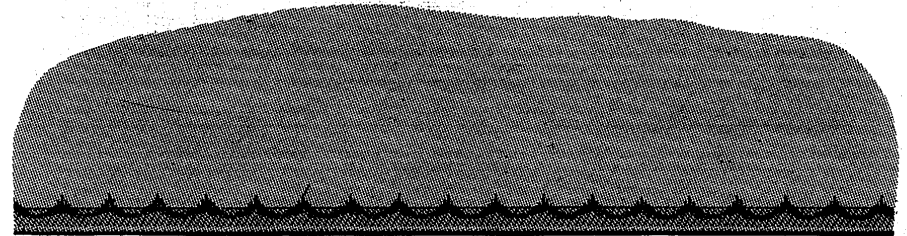
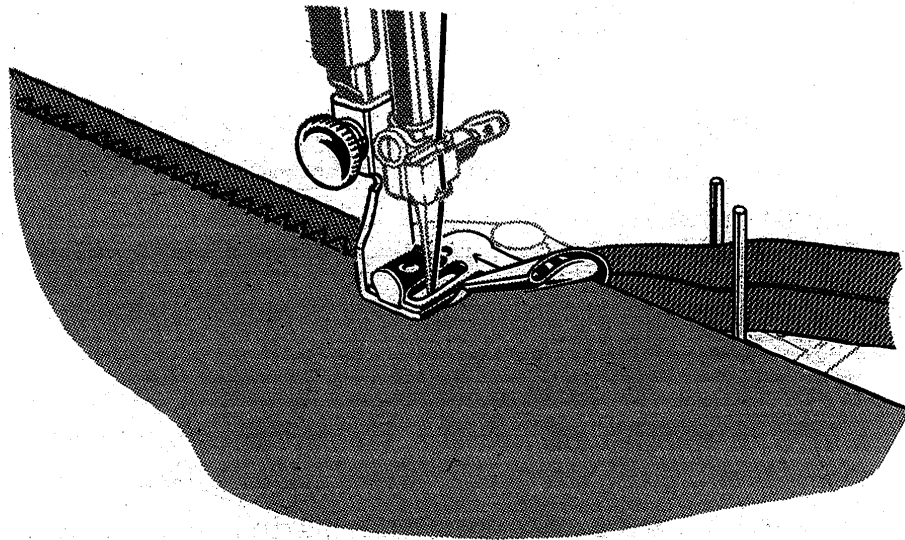

THE RUFFLER

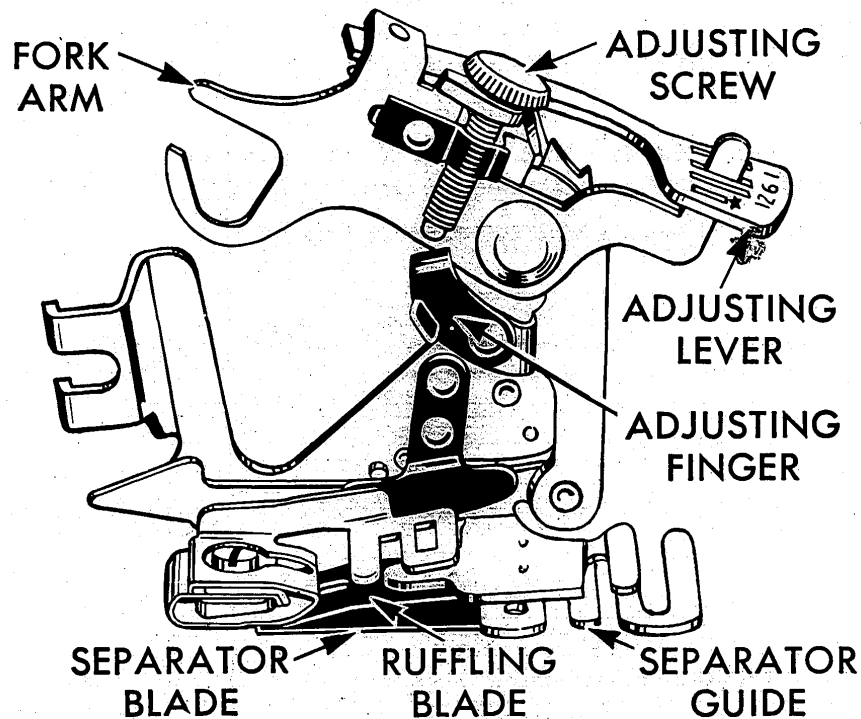

This attachment offers a simple and effective way to make gathered and pleated ruffles. Ruffles may be made separately or made and applied at the same time. The ruffler is attached to the machine in place of the regular presser foot and is used with a straight stitch setting only.

SELECTOR: AK
 RED LEVER: 3
 THROAT PLATE: STRAIGHT STITCH
 RUFFLER

Adjusting Points. 1. The adjusting lever sets the ruffler for gathers or pleats. The Number 1 space setting is for gathers, and places fullness at every stitch. Numbers 6 and 12 are space settings for pleats, spacing them either 6 or 12 stitches apart. The star is for straight stitching, and is used when grouping gathers or pleats.

2. The adjusting finger is used only for pleating and affects the width of the pleat. It is thrown out of action by bringing it out of contact with the adjusting screw, located directly above it.

3. The adjusting screw regulates the fullness of gathers or pleats. When turned down to its limit with the adjusting finger in place, the attachment is set for its deepest pleat. When turned upward to its limit and the adjusting finger out of action, the ruffler gives only a hint of fullness.

THE RUFFLER

Activating Parts. The ruffling blade and the separator blade are of blue steel and hold the material to be gathered between them. The ruffling blade forms the gathers or pleats by carrying the fabric to the needle according to the spacing and fullness to which the ruffler is adjusted. The separator guide is slotted to guide seam edges evenly and to separate the ruffle strip from the material to which the ruffle is attached.

Preparation. Raise the needle to its highest point.

Locate the attachment on the machine in place of the regular presser foot, at the same time fit the fork arm over the needle clamp screw. Make sure both the presser bar screw and the needle clamp screw are tightened securely.

Gathering. Set the adjusting lever of the attachment on Number 1 setting, and throw the adjusting finger out of action. Turn the adjusting screw for the amount of fullness desired and set the stitch length to space the fullness. The attachment is adjusted for maximum fullness by turning the adjusting screw all the way down; for less fullness turn it upward.

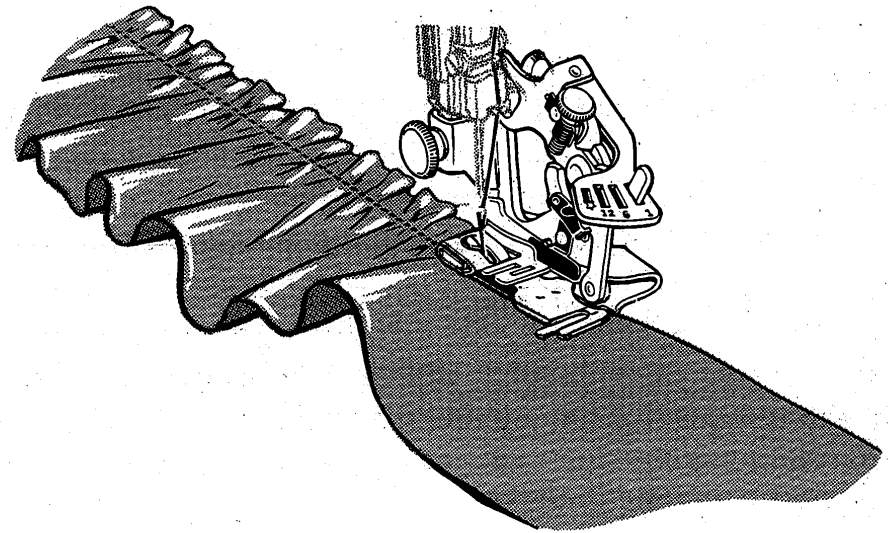

THE RUFFLER

The length of the sewing machine stitch also affects ruffle fullness. Since a given attachment setting puts an equal amount of fullness into each stitch regardless of its length, shortening the stitch (more stitches to the inch) makes the ruffle more full, lengthening the stitch (few stitches to the inch) makes it less full. For fine, closely spaced gathering use a short stitch and an upward adjustment of the adjusting screw. For deeper, less closely spaced gathering, turn the adjusting screw downward and use a medium length stitch.

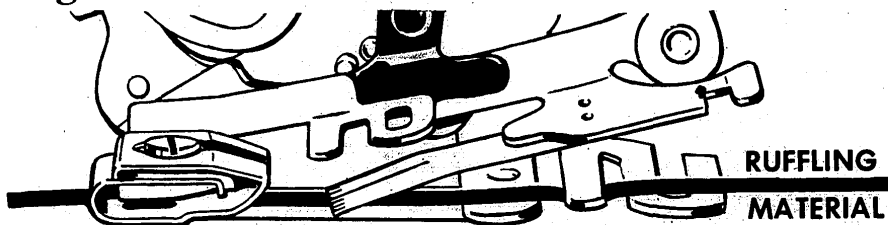

Insert the material to be gathered between the blue blades and through the first separator guide. Draw to the back of the needle. Lower the presser bar and stitch. The texture of the fabric influences the performance of the ruffler as well as the results. Soft fabrics, cut on the crosswise grain, are best adapted for gathered ruffles. Always test stitch length and ruffler setting on a scrap of self fabric before proceeding with the actual work.

Attaching Ruffle. To form and attach a ruffle in one operation, place the ruffle strip between the two blue blades and through the first separator guide, and the material to which it is to be

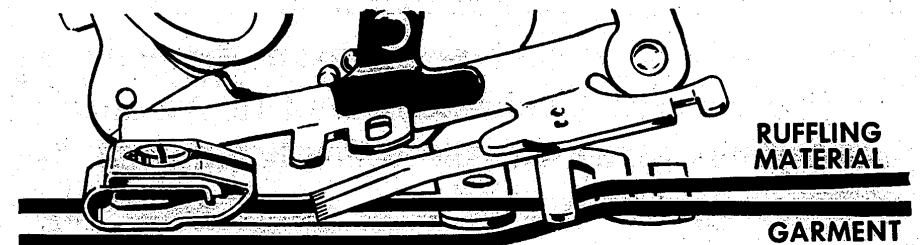

attached between the separator blade and the feed of the machine. Proceed as for plain gathering. Right sides of the fabric are placed together when the seam is to fall to the inside.

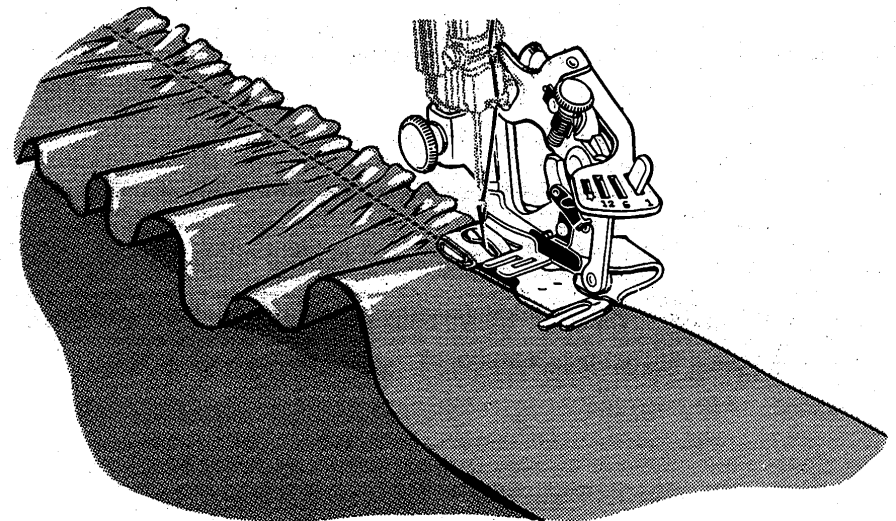

THE RUFFLER

Pleating. Move the adjusting lever of the ruffler to the space setting desired for pleats either 6 or 12 stitches apart.

For the deepest pleat, activate the adjusting finger and turn the adjusting screw downward to its maximum setting. For smaller pleats turn the adjusting screw upward.

Set stitch length. A short stitch places the pleats more closely together; a long stitch separates the pleats for a greater distance.

Insert the fabric to be pleated between the blue blades and into the first separator guide. Lower presser bar and stitch.

Crisp fabrics cut on the crosswise grain form the sharpest pleats. Glazed fabrics handle best if the glazed side is downward and the soft backing is next to the ruffler blade.

Group Pleating. By using the star setting (straight stitching) alternately with the 6 or 12 stitch setting, pleats are formed in groups. Even spacing between groups is accomplished by counting the number of stitches.

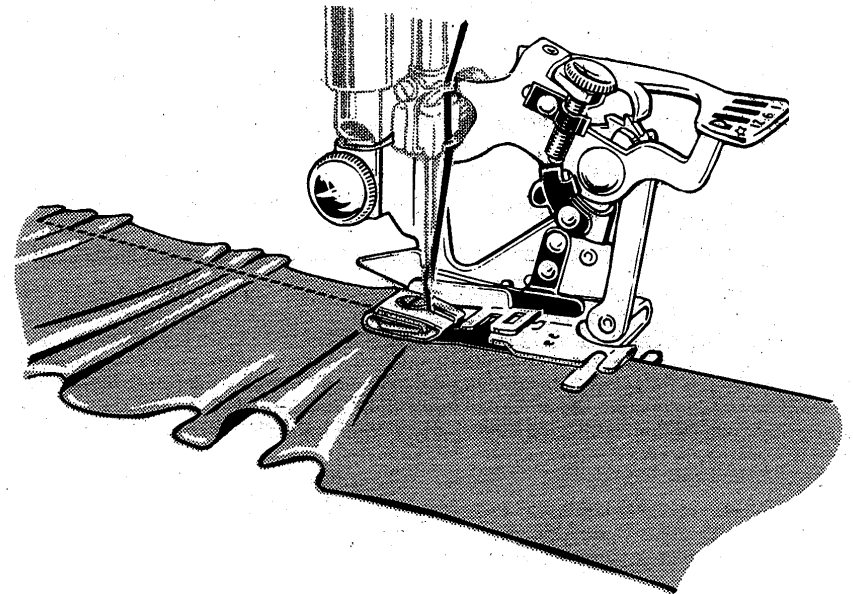
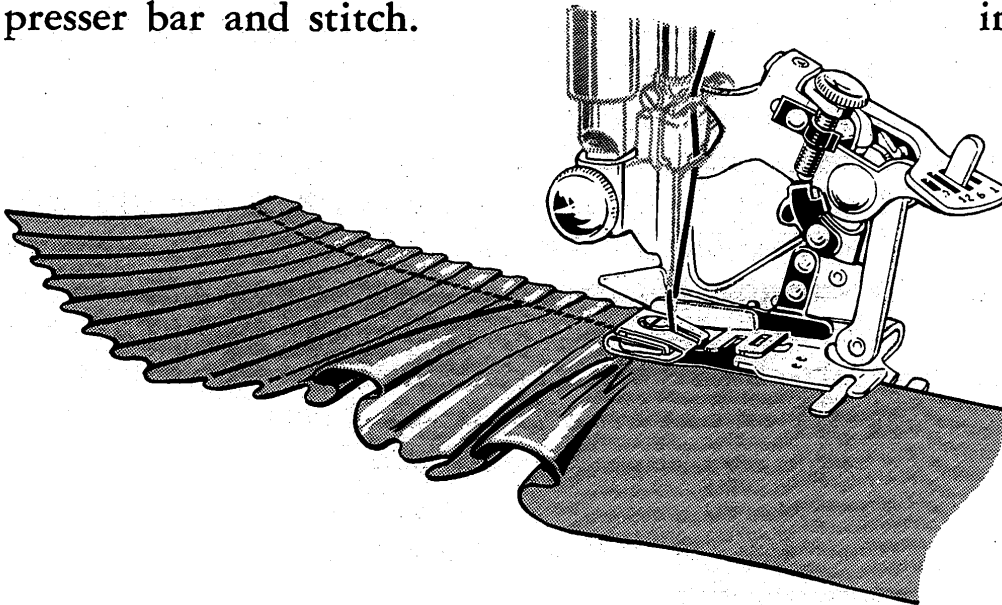

DARNING

SELECTOR: AK
RED LEVER: 3
THROAT PLATE: STRAIGHT STITCH (RAISED)
PRESSER FOOT: NONE
STITCH LENGTH: FINEST

Household linens, children's clothes and knit wear of all kinds can be repaired with the darning stitch.

Trim away any ragged edges from the area to be darned. Center the worn section in embroidery hoops or the SINGER Stocking Darner (available separately) to hold it taut.

Remove the presser foot and raise the throat plate. Set Selector at AK and Red Lever at 3

Position the work under the needle and lower the presser bar to activate the tension. Hold the needle thread loosely with the left hand, turn the hand wheel over and draw the bobbin thread up through the fabric with the loop of the needle thread. Hold both thread ends and lower needle into fabric.

Outline opening with running stitches $\frac{1}{4}$ " from edge for reinforcement.

Stitch across the opening, moving the hoops under the needle at a slight angle, from lower

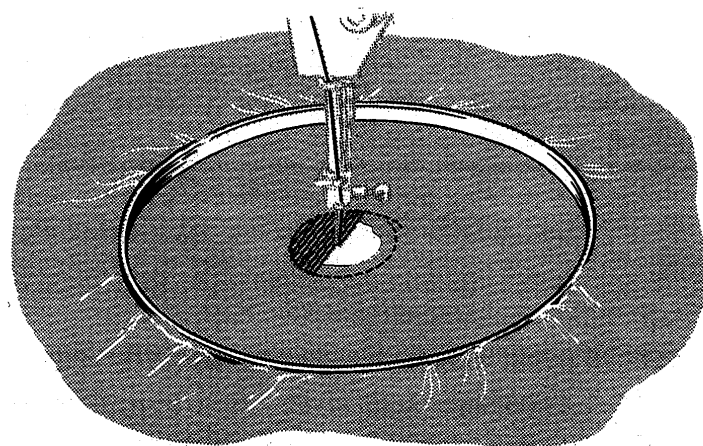

left to upper right. Keep lines of stitching closely spaced and even in length.

Run machine at a moderate speed and control the hoops with a steady continuous movement. Slow movement of hoops will produce a short stitch, while more rapid movement lengthens the stitch. Fairly long stitches are best for knit and tricot fabrics as they are softer and more flexible when the garment is worn. Short stitches are best for cottons and household linens as they approximate the weave of the fabric and are strong enough to withstand many launderings.

The darning and embroidery foot (available separately) will also contribute to the smooth handling of difficult materials as it provides a close control of both stitch and fabric.

FREE MOTION WORK

SELECTOR: BL
RED LEVER: 2-5
THROAT PLATE: GENERAL PURPOSE (RAISED)
PRESSER FOOT: NONE
STITCH LENGTH: FINEST

Script monograms, satin stitched scallops and embroidery can be effectively accomplished with the zigzag stitch when the free motion principle is employed.

Trace or mark the design on the right side of the fabric. Place the work in embroidery hoops, keeping the fabric taut.

Remove the presser foot and raise the throat plate. Set Selector at BL and Red Lever at desired setting.

Position the work under the needle and lower the presser bar to activate the tension. Bring the bobbin thread up through the fabric. Hold both thread ends and start stitching after positioning needle in fabric.

Move the hoops slowly following the outline of the design. Maintain an even rate of speed so that the stitches are uniformly placed. Shading the stitches from wide to narrow is controlled by the angle at which the work is placed and moved under the needle.

When scalloping is used as an edge finish, allow sufficient margin of fabric beyond the desired edge to fit the hoop. To maintain parallel stitches, scallops are followed without turning, the work remaining in line with the feed at all times. The points of the scallops are formed by lightly moving the work to the right or left, automatically producing the effect of a narrower stitch.

Some fabrics may require the addition of an underlay of crisp muslin or organdy. The darning and embroidery foot (available separately) will also contribute to the smooth handling of difficult materials as it provides a close control of both stitch and fabric.

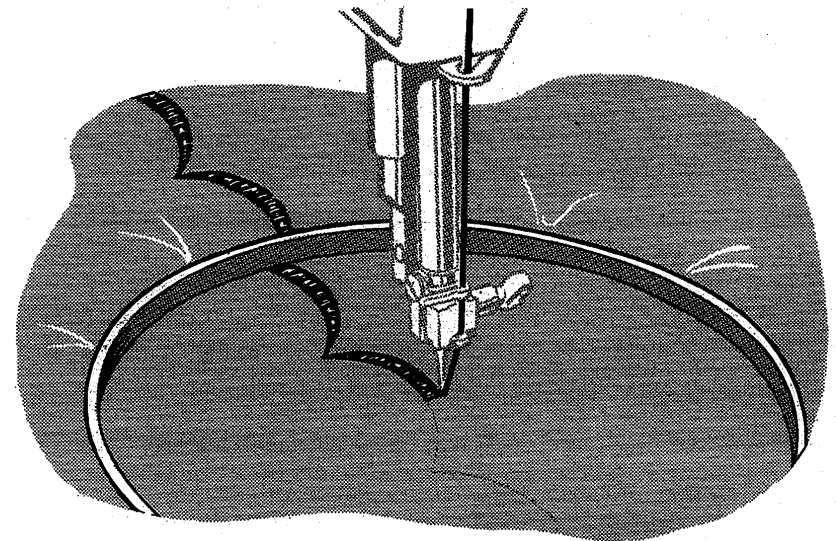

DECORATIVE STITCH PATTERNS

Examples of Stitch Patterns and their Selector Settings

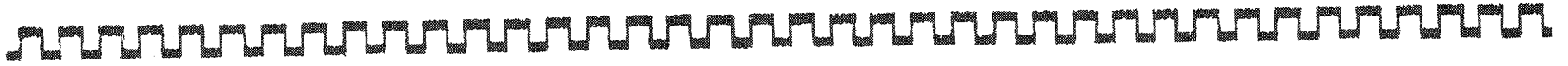

DP 4



DS ② 2



DS ② 3



EP 2



FO 2



FR 2



FS ① 3

DECORATIVE STITCH PATTERNS

Examples of Stitch Patterns and their Selector Settings



GM 4



GP 4



GS ② 2



GS ③ 4



HS ③ 4



IL 2



IS ① 4

SEWING SAMPLE PAGES

SELECTOR AND RED LEVER SETTINGS

PAGE A



TWO NEEDLES
AL3



TWO NEEDLES
AM3



TWO NEEDLES
AN3



TWO NEEDLES
AO3

PAGE B



TWO NEEDLES
AP3



TWO NEEDLES
AQ3



TWO NEEDLES
AR3



TWO NEEDLES
AS ① 3

PAGE C



TWO NEEDLES
AS ② 3



TWO NEEDLES
AS ③ 3



TWO NEEDLES
AS ④ 3



TWO NEEDLES
AS ⑤ 3

SEWING SAMPLE PAGES

SELECTOR AND RED LEVER SETTINGS

PAGE D

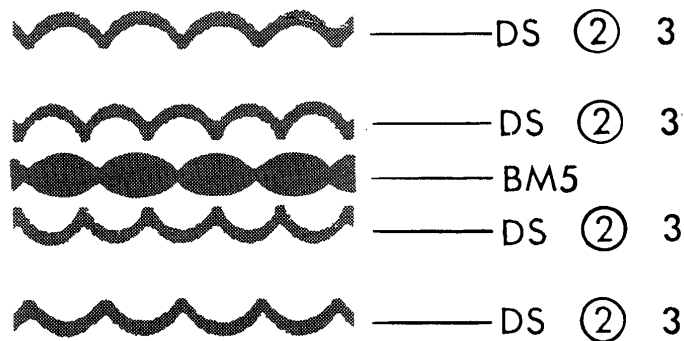
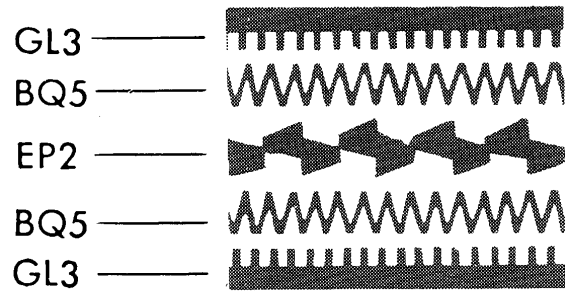
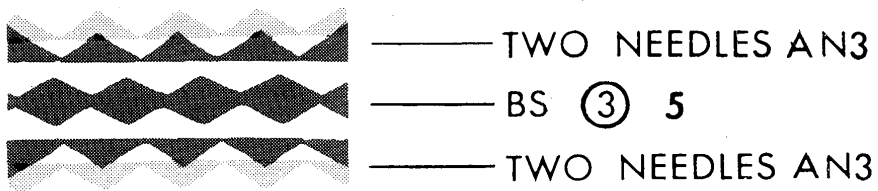

PAGE E

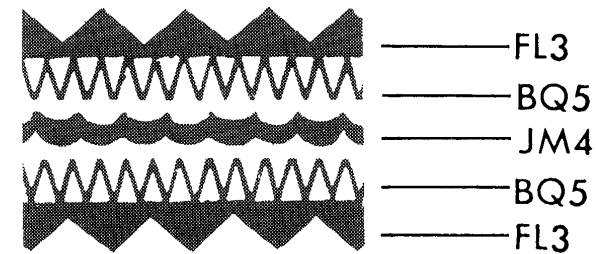
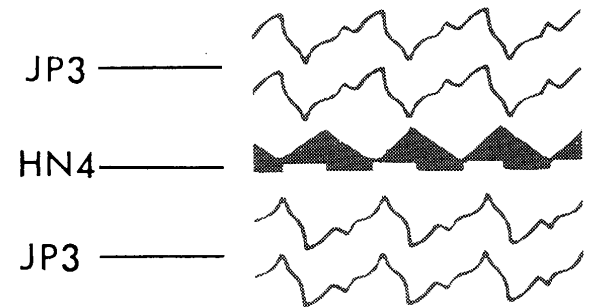
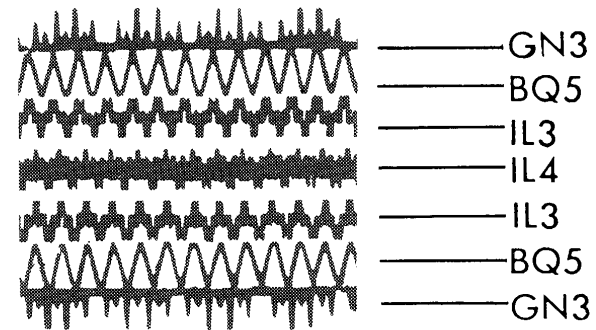

SEWING SAMPLE PAGES

SELECTOR AND RED LEVER SETTINGS

MONOGRAMS
PAGE F

BL 2½
BS ③ 5



BL 3
JL 3

MONOGRAMS
PAGE G

BL 2½
IL 4
BM 3-4-5



GL 4
GN 4
BL 3

MOTIFS
PAGE H

BM 5
BL 2½



BL 2
BM 4-5
BS ④ 3-5





MOTIFS
PAGE I





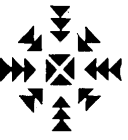

BL 1¾
BS ④ 4-5
BL 4-5



BL 2½
GN 4
BM 5

SEWING SAMPLE PAGES
SELECTOR AND RED LEVER SETTINGS

MOTIFS PAGE J	}		GS ③ 5
			BN 5
			BL 2 BS ③ 5
EMBROIDERY PAGE K			FREE MOTION BL 3-4-5
APPLIQUE PAGE L			BL 2½ IL 3 GL 3 BM 5 AK 3

APPLIQUE PAGE M		BL 2½-3-4
APPLIQUE PAGE N		FREE MOTION HOOPS BL 2
EMBROIDERY PAGE O		AK 3 FREE MOTION BL 5
SCALLOPING AND COUCHING PAGE P	}	 BS ② 5  HO 3  BO 4

FASHION* AIDS

Available for separate purchase at your local SINGER CENTER

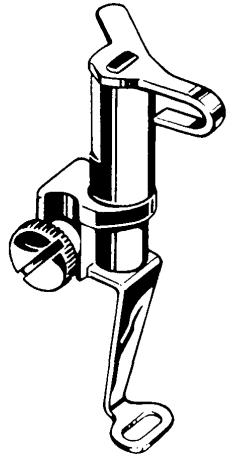
DARNING AND EMBROIDERY ATTACHMENT

Fabrics that require skillful handling may be darned and embroidered with expert results when the Darning and Embroidery Foot is used.

This attachment is an aid to all who desire perfection in free motion embroidery and applique work.

The foot firmly holds the fabric as the needle enters and rises from the work, while fully revealing the line of design to be followed.

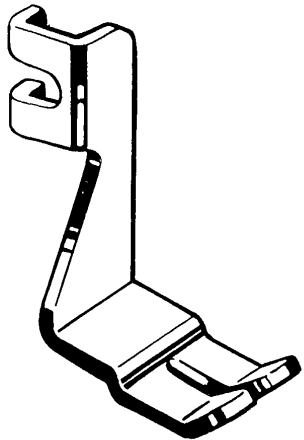
THE GATHERING FOOT

Single or multiple rows of shirring can be quickly and expertly placed with this attachment. Evenly spaced shirring is insured as this foot is designed to lock fullness into each stitch. The amount of fullness is very simply controlled by stitch length and degree of tension.

Use straight stitch setting only.

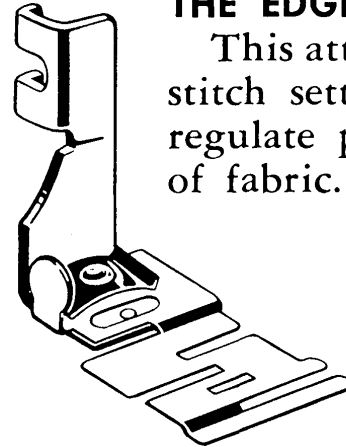
THE EDGE STITCHER

This attachment, used with the straight stitch setting, has slotted guides which regulate placement of stitching at edge of fabric.

Among its many applications are the joining and insertion of lace, tucking from pin width to 1/4", French seaming and seam piping, facing and seam finishing.

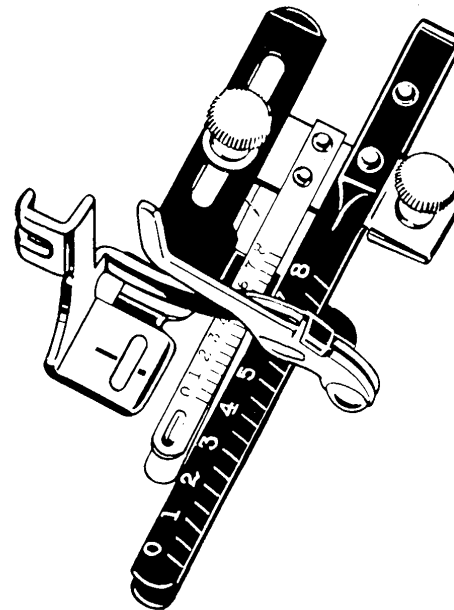
THE TUCKER

Since the beauty of tucking lies in explicit accuracy, the Tucker will contribute greatly to the attractiveness of this work.

Tucks up to 1" may be stitched and marked in one operation.

Two adjustable scales are provided to gauge tuck width and spacing.

Use either straight or decorative stitch setting.

TO REMOVE AND REPLACE STITCH PATTERN PLATE COVER

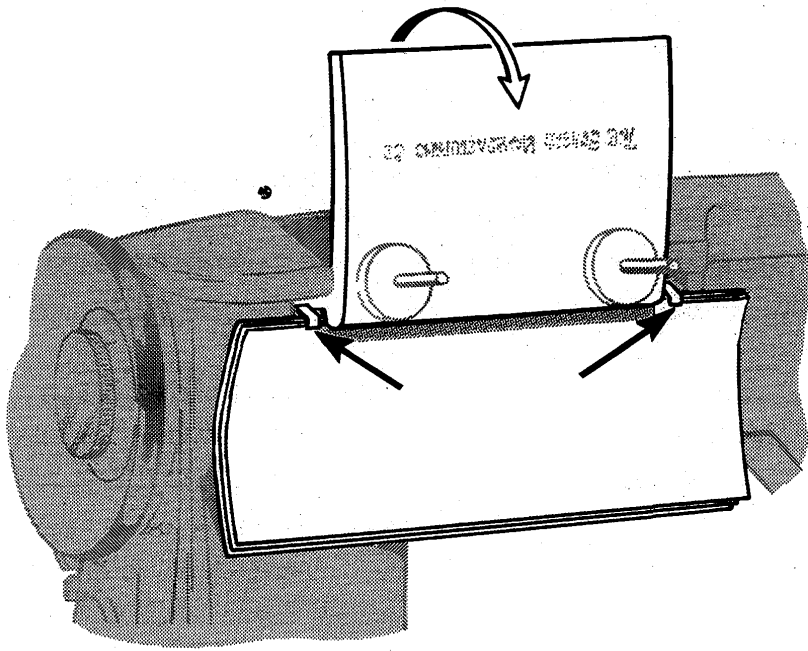

TO REMOVE

Place several sheets of paper under the two springs as illustrated. Turn cover all the way back until it snaps off. The paper will prevent damage to machine arm during cover removal.

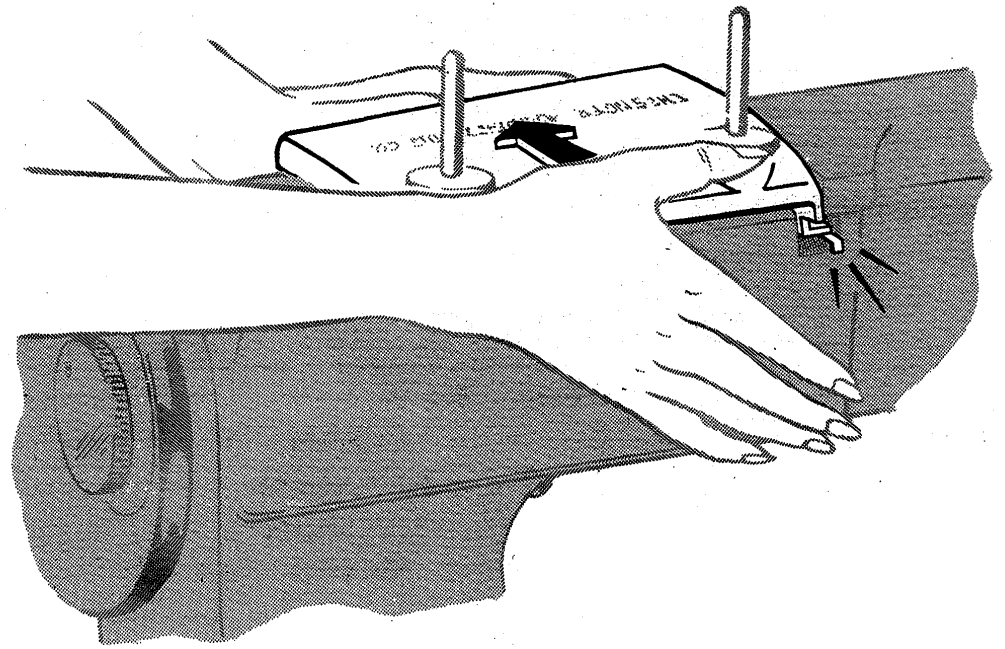

TO REPLACE

Position cover with lugs resting on top of springs. Push cover in the direction shown until it snaps into place.

TO CLEAN THE MACHINE

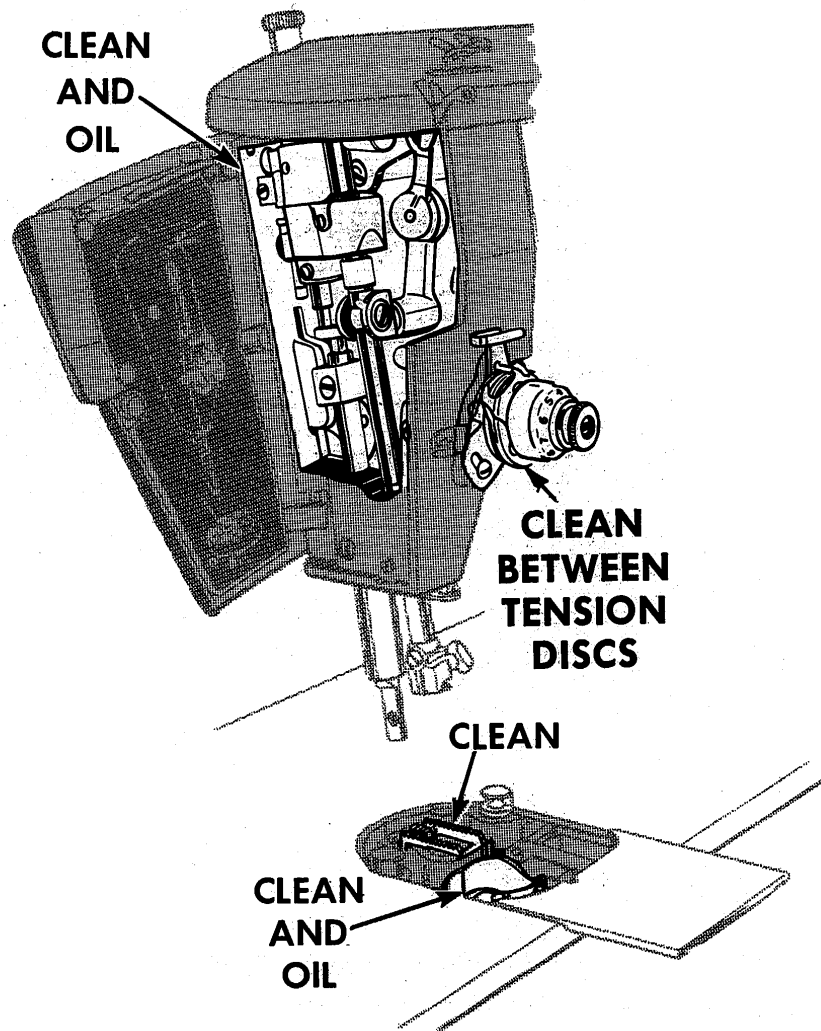

Your sewing machine was built to exacting standards of precision and workmanship. Its performance depends on the care and treatment it receives when in use and before storing it away.

When in regular use, the machine should be cleaned periodically to remove the lint and fluff which may have accumulated around the working parts. To clean the bobbin case area, see instructions for removing and replacing bobbin case on **pages 87 and 88**. Oil the machine after each cleaning as instructed on **pages 89, 90 and 91**.

If the machine is to be stored away for an indefinite period of time, a thorough brush-cleaning to remove all traces of lint and fluff, followed by swabbing of all exposed parts with a lint-free brush saturated with SINGER* Oil, is necessary to protect the machine against rust damage. The areas that should be cleaned and covered with a protective coat of oil are shown in the illustration at the left.

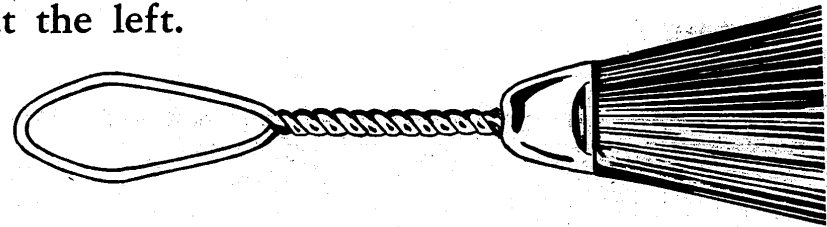

TO REMOVE AND REPLACE BOBBIN CASE

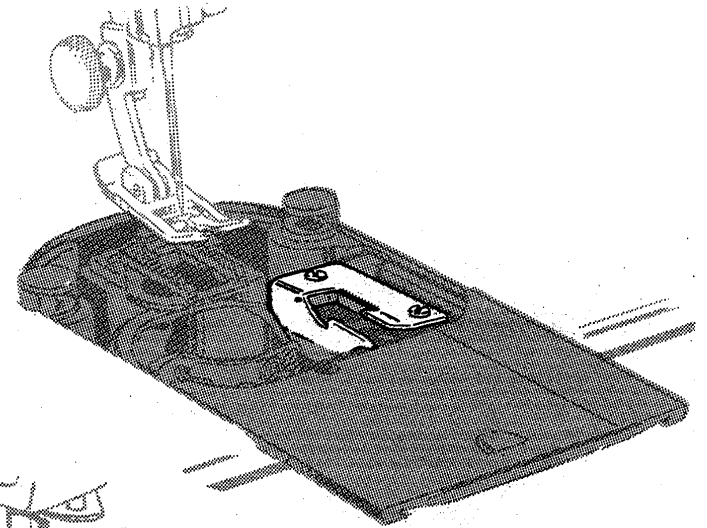
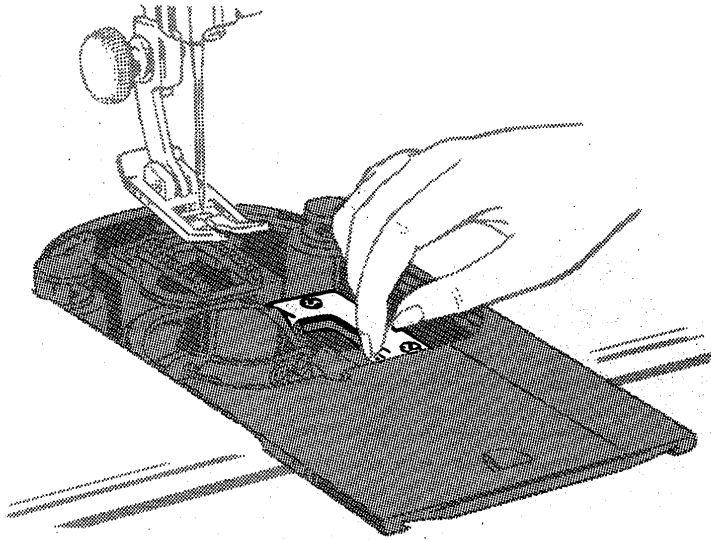

To clean hook raceway, remove bobbin case as follows:

1. Remove throat plate (see **page 17**) and open slide plate (see **page 10**).
2. Unlock bobbin case by lifting and pulling holder to right as shown.
3. Remove bobbin case from machine.
4. Remove all lint, fluff, loose thread ends or any other foreign matter which might clog the machine.

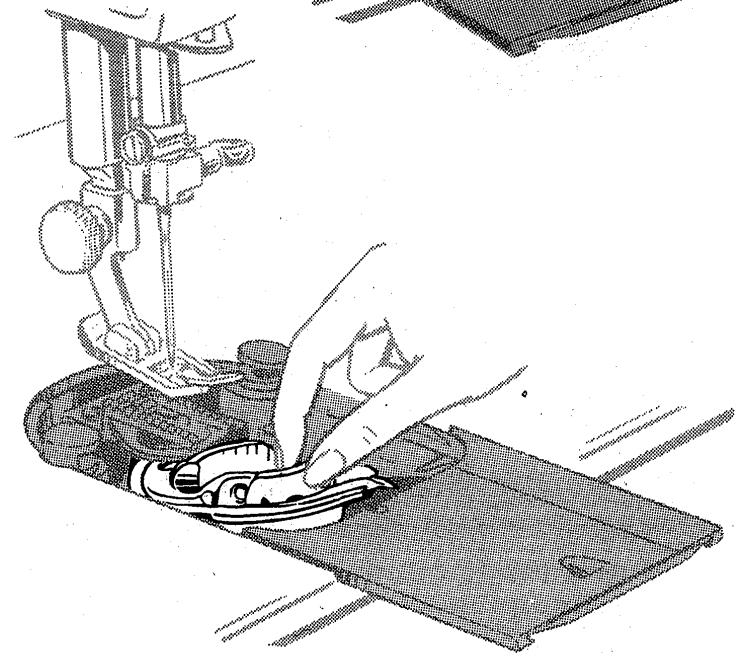

**POSITIONING
STUD**

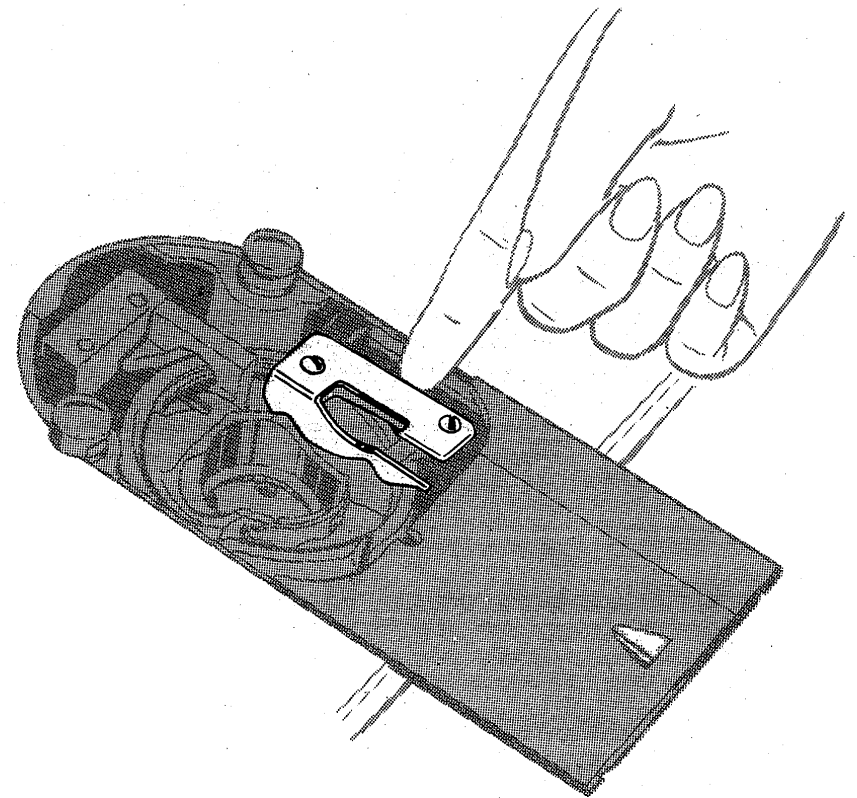
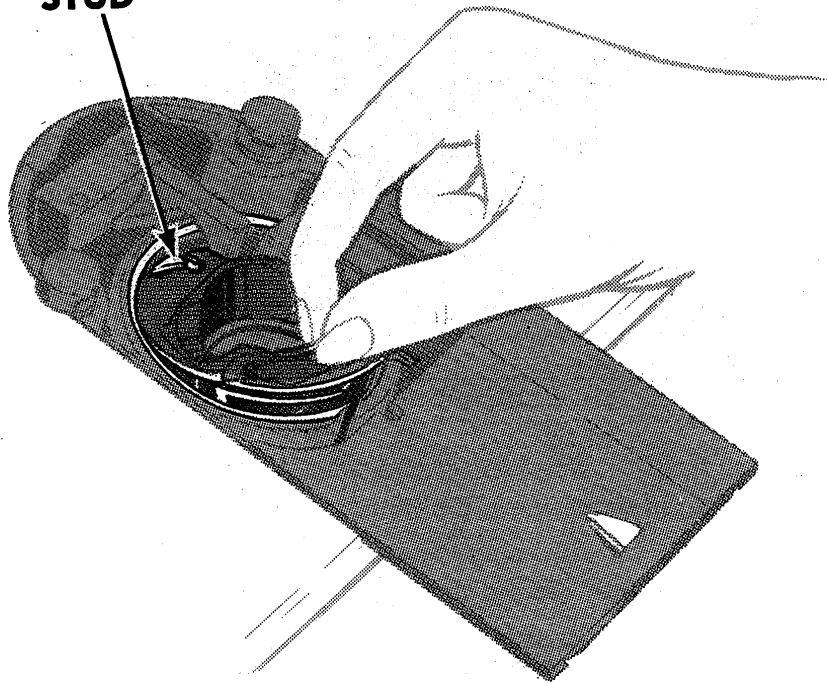

5. Replace bobbin case so that groove under tension spring fits on hook raceway and fork of case straddles positioning stud.
6. Push bobbin case holder to left as shown until it snaps down into lock position.
7. Close bed slide and replace throat plate.

TO LUBRICATE THE MACHINE

Use **SINGER Oil** and **SINGER Lubricant**!

Both are extra quality products especially prepared for sewing machines, and should always be used in the care of your 401.

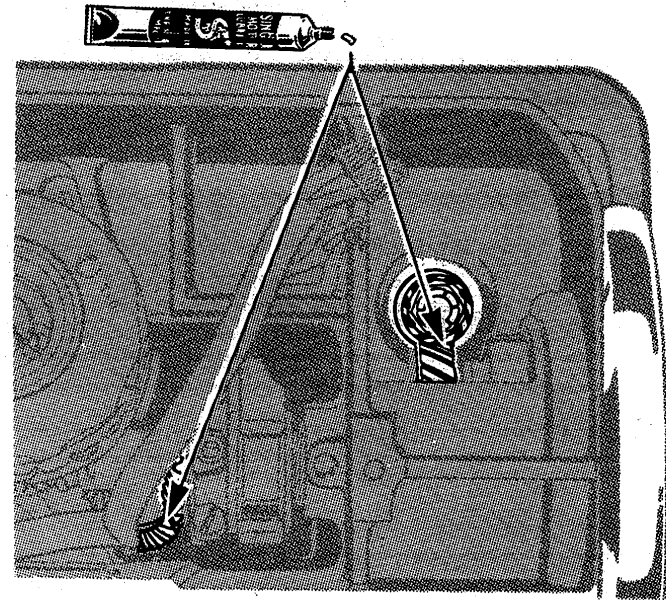
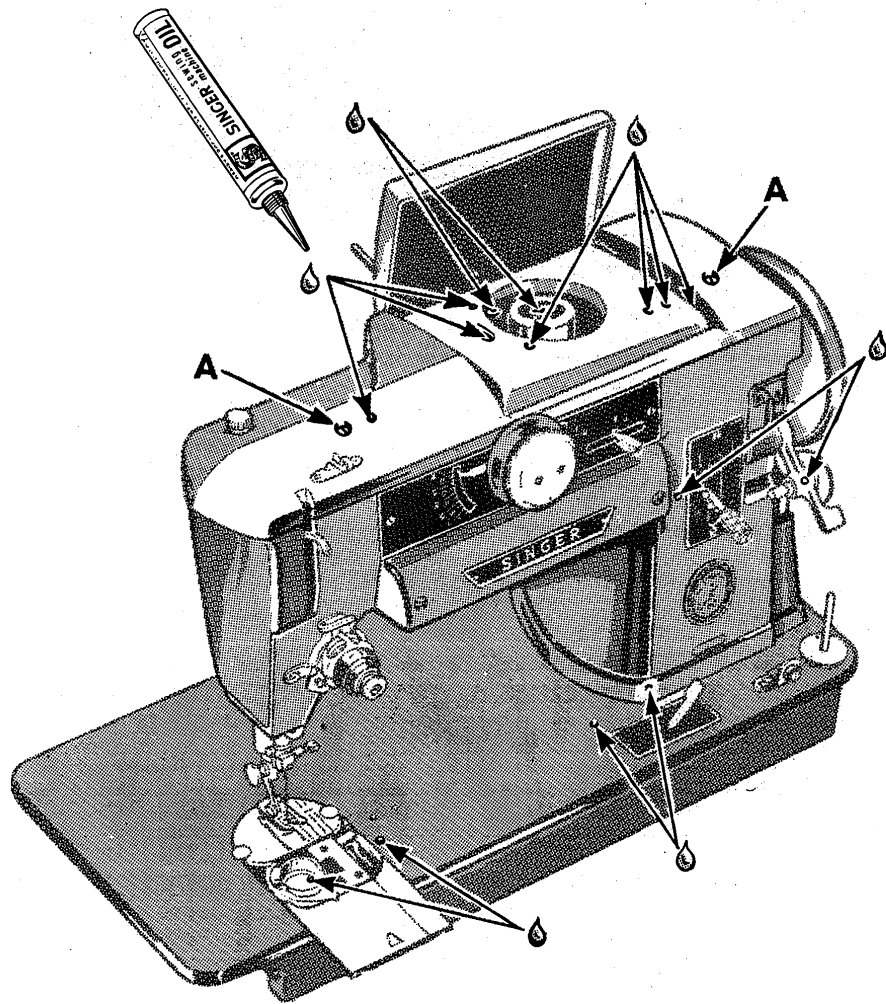

Clean the machine periodically as instructed on **page 86**.

Apply a drop of oil to each place indicated. Remove screws **A** and lift off arm top cover. Apply a small amount of lubricant to the gears as shown.

A tube of this lubricant can be purchased at your Singer Sewing Center.

NEVER APPLY OIL TO THESE GEARS.

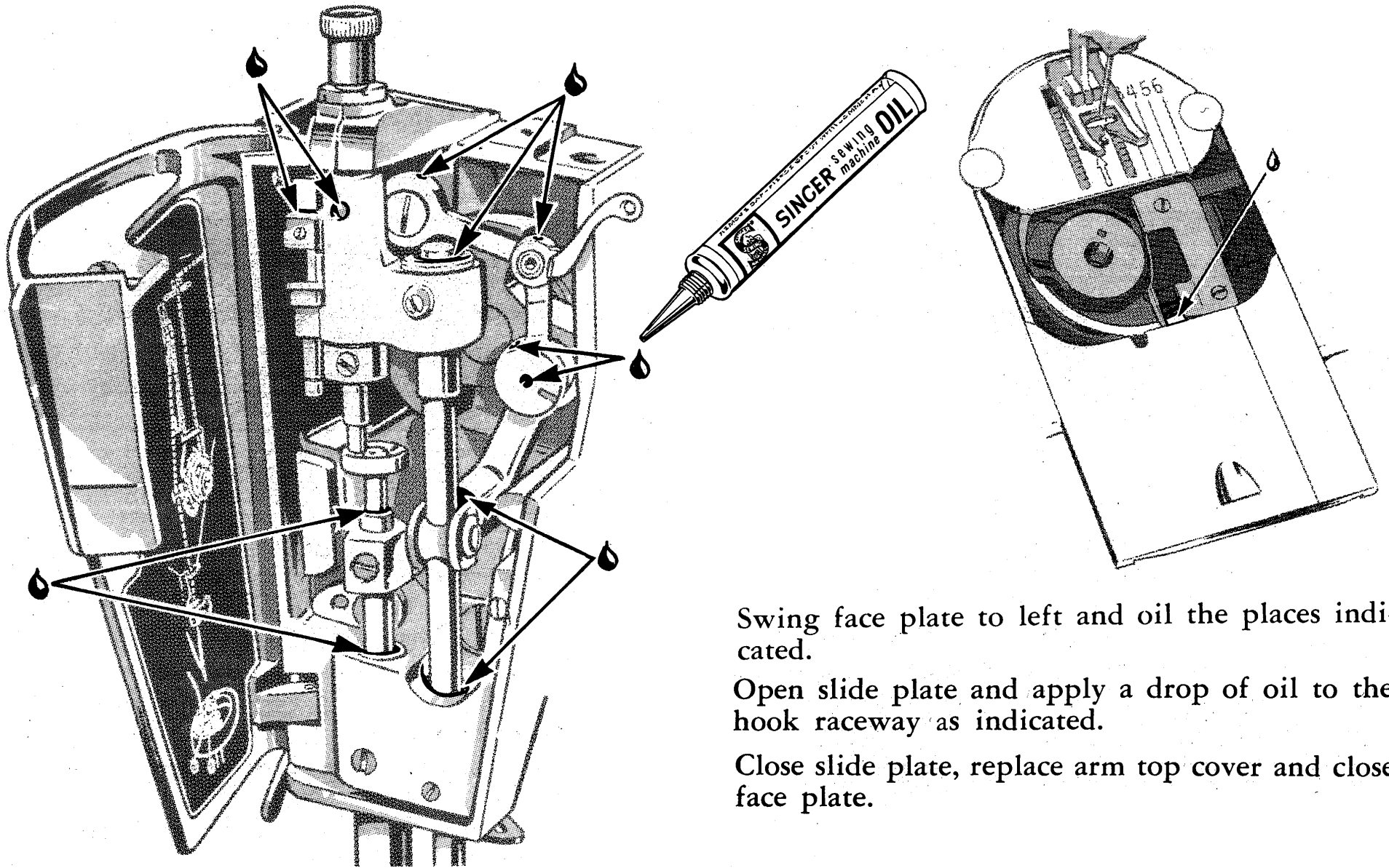

Swing face plate to left and oil the places indicated.

Open slide plate and apply a drop of oil to the hook raceway as indicated.

Close slide plate, replace arm top cover and close face plate.

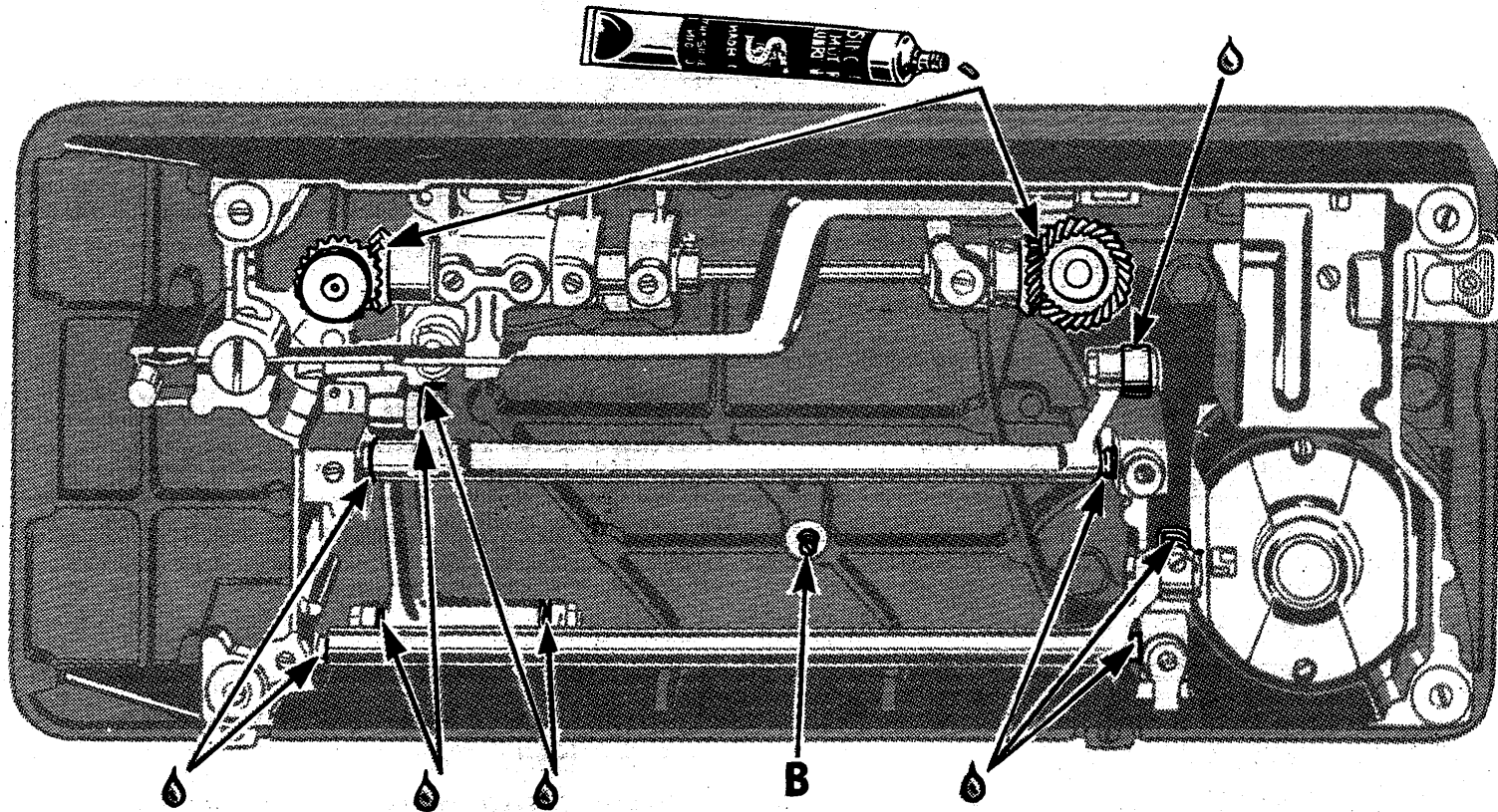

Tilt machine back and remove thumb nut from screw **B**, being careful not to lose felt washer, and remove cover from underside of machine.

Oil each of places indicated by arrows and occasionally apply a small quantity of lubricant to teeth of gears as shown.

Replace bottom cover.

THE MOTOR REQUIRES NO LUBRICATION.

ELECTRICAL INFORMATION

The **SINGER* Electric Motor** in your sewing machine is furnished for operation on an alternating current of 110-120 volts, 25 to 75 cycles, or on 110-120 volts direct current. Special motors can be provided through your **SINGER CENTER** for direct or alternating current for any voltage between 50 and 145, and for 32 volts direct current.

Before Inserting Electric Plug, be sure that the voltage and the number of cycles stamped on the two-pin terminal block are within the range marked on your electric meter installed by your power company.

Electrical Connections for Machine. Push 2-pin terminal plug **A** on 2-pin terminal block at right end of bed.

Push 2-pin terminal plug **B** on 2-pin terminal block at right of machine and connect plug at other end of cord to electrical outlet.

Speed Controller. The speed of machine is regulated by amount of pressure on the pedal of the foot controller or the knee lever.

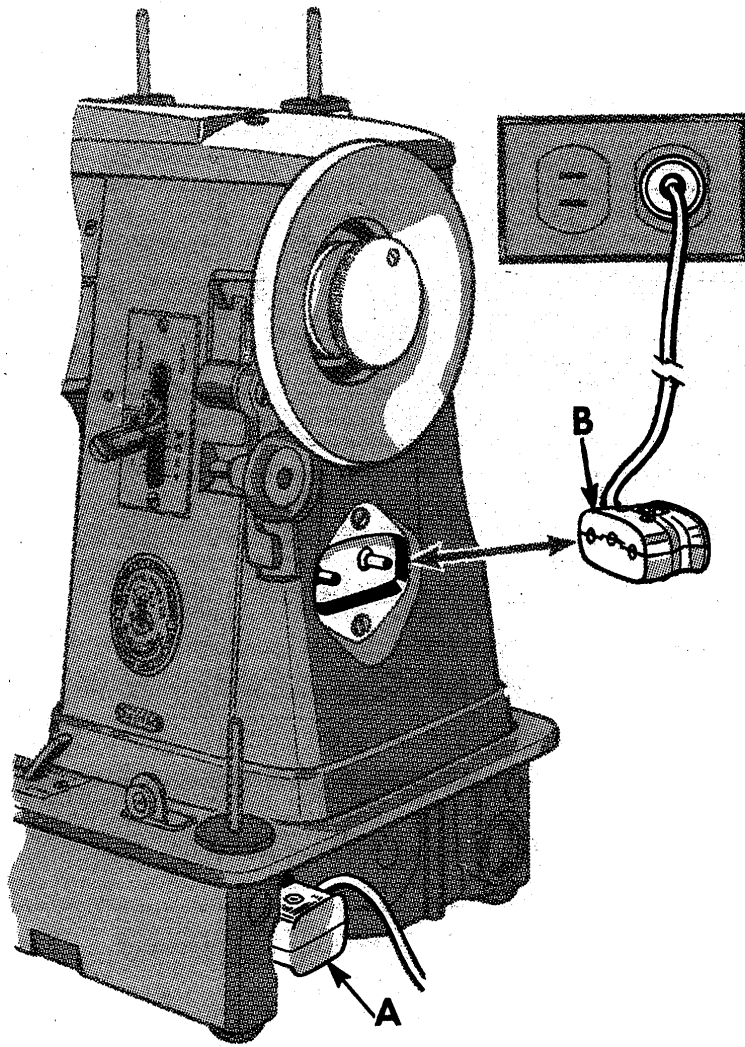

SINGER* LIGHT

The light is turned "on" or "off" by the switch **F**.

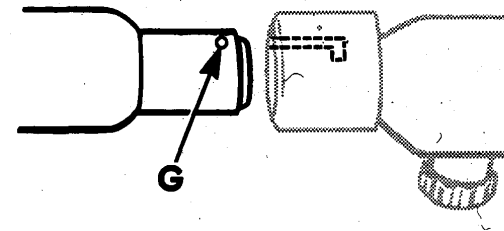
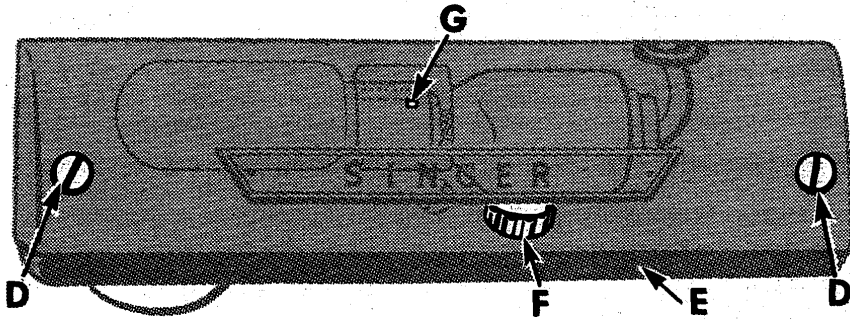

To Remove Bulb. Remove two screws **D** and lamp cover **E**. Do not attempt to unscrew bulb. Press it into socket and at same time turn bulb over in direction shown to unlock bulb pin **G**, then withdraw bulb.

To Replace Bulb. Press new bulb into socket with bulb pin **G** entering slot of socket and turn it over in direction shown to lock bulb pin **G** in position. Replace lamp cover **E** and securely fasten it in position with two screws **D**.

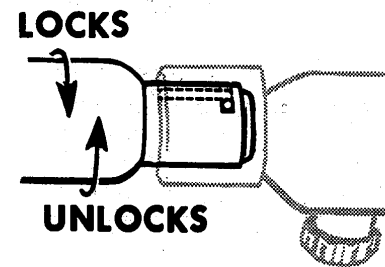

INDEX

	PAGE		PAGE
Applique	44-45	Darning	76
Illustrations of Samples	L-M-N	Darning and Embroidery Attachment	84
Attachments		Darts	54-55
Foot Hemmer	67-69	Interfacing	55
Multi-Slotted Binder	70-71	Single Thread	54
Ruffler	72-75	Decorative Hems	69
Binding	70-71	Decorative Stitch Patterns	78-79
Blanket Binding, Replacing	55	Designs and Motifs	46
Blind Stitching		Illustrations of Samples	H-I-J-K
Hems	60	Edge Stitcher	84
Zipper Insertion	64	Elastic	
Bobbin		Applied Band	56
Case Threading	11	Girdle Repair	56
Preparation for Stitching	20	Electrical Information	92-93
Removing	10	Motor	92
Thread Tension	26	SINGER Light	93
Winding	8-9	Embroidery: Free Motion	76-77
Border Designs		Fabric, Thread, Needle and Stitch Length Chart	5
Coding	81	Fabrics, Guiding and Supporting	23
Illustrations of Samples	D-E	FASHION Aids	84
Buttonholes	40-43	Darning and Embroidery Attachment	84
Corded	43	Edge Stitcher	84
Button Sewing	49-50	Gathering Foot	84
Chart for Fabric, Thread, Needle and Stitch Length	5	Tucker	84
Cleaning	86-88	Features	3
Codes for Sewing Sample Pages	80-83	Principal Parts	12
Combination Patterns and Variations	35	Filler Cord, Threading	43
Illustrations	78-79	Finishes, Seam	53
Corded Applique	45	Foot Hemmer	67-69
Corded Buttonholes	43	Decorative Hems	69
Cording		Hemming with Lace	68
Seams	66	Free Motion Work	76-77
Welting	65	Illustrations of Samples	K-N-O
Couching	48	Darning	76
Illustration of Sample	P	Embroidery	77

	PAGE
Monograms	77
Satin Stitch Scallops	77
Gathering	73
Gathering Foot	84
General Purpose Foot, Applications	51-57
Guiding and Supporting Fabric	23
Hemming with Lace	68
Hems	
Blindstitched	60
Decorative	69
Interfacing Darts	55
Knit Fabric Seams	52
Lace	
Applique	45
Edging and Insertion	48 and 68
Length of Stitch, Regulating	13
Light Bulb, Replacement	93
Lubricating	89-91
Mending	56
Monograms and Motifs	46
Free Motion	77
Illustrations of Samples	F-G-H-I-J-O
Motor	92
Multi-Slotted Binder	70-71
Needle Insertion	6 and 36
Needle Positions	19 and 34
Needle, Thread, Fabric and Stitch Length Chart	5
Needle Thread Tension	
Satin Stitching	29
Straight Stitching	25
Needle Threading	
Single	7
Two	37
Oiling	89-91
Overcasting	53
Pleating	75

	PAGE
Prepare to Sew	20
Pressure Adjustments	24
Primary Patterns	30-34
Needle Position	34
Red Lever	33
Special Discs	31-32
Principal Parts of Machine	12
Red Lever	
Combinations and Variations	35
Control of Width	33
Operation	14
Removal and Replacement of Bobbin	10
Removal and Replacement of Special Discs	32
Removal and Replacement of Stitch Pattern	
Plate Cover	85
Rent or Tear Mending	56
Reverse Stitching	
Application	21-22
Regulation	13
Ruffler	72-75
Attaching Ruffle	74
Gathering	73
Pleating	75
Sample Page Codes	80-83
Satin Stitching	
Stitch Length Adjustment	28
Tension Adjustment	29
Scalloping	57
Free Motion	77
Illustrations of Samples	O-P
Primary Patterns	30
Special Disc	31
Seam Finishes	53
Seam Guide	58-60
Blindstitched Hems	60
Seams	58-59
Top Stitching	59

	PAGE		PAGE
Seams		Thread, Needle, Fabric and Stitch Length Chart....	5
Corded	66	Threading	
Flat Felled	52	Bobbin Case	11
Knit Fabric	52	Filler Cord	43
Lingerie	51	Single Needle	7
Sheer Fabrics	47	Two Needles	37
Straight	21-22	Throat Plate	
Supporting and Guiding	23	Changing	17
Selector: Operation	15	Positions	16
Sheer Fabric Seams	47	Straight Stitch	18
SINGER Service	4	Zigzag Stitch	27
Single Thread Darts	54	Top Stitching	59
Special Discs		Tucker	84
Primary Patterns	31	Two Needles	36-39
Removal and Replacement	32	Coding	80-81
Special Purpose Foot, Applications	40-48	Illustrations of Samples	A-B-C
Stitch Length		Insertion	36
Regulator	13	Primary Patterns	39
Satin Stitch Adjustment	28	Straight Stitching	38
Stitch Length, Fabric, Thread and Needle Chart....	5	Threading	37
Stitch Pattern Plate Cover		Variation and Combination Patterns	35
Removing and Replacing	85	Illustrations	78-79
Stitch Patterns		Welting	65
Combinations and Variations	35	Winding a Bobbin	8-9
Illustrations	78-79	Zigzag Stitching	
Special Discs	31	Combinations and Variations	35
Stitch Selector, Operation	15	Equipment	27
Straight Stitching		Needle Positions	34
Equipment and Settings	18-19	Primary Patterns	30
Seams	21-22	Red Lever: Control of Widths	33
Secondary Positions	19	Special Discs	31-32
Two Needles	38	Stitch Length Adjustment	28
Tear or Rent Mending	56	Tension Adjustment	29
Tension Adjustments		Two Needles	39
Bobbin	26	Zipper Foot	61-66
Needle Thread	25	Welting and Corded Seams	65-66
Satin Stitching	29	Zipper Insertion	62-64

To all whom it may concern:

The improper placing or renewal of the trademark "**SINGER**" or any other of the trademarks of The Singer Company (all of which are duly Registered Trademarks) on any machine that has been repaired, rebuilt, reconditioned, or altered in any way whatsoever outside a SINGER factory or an authorized SINGER agency is forbidden.

For your protection

SINGER Sewing Machines are sold and serviced wherever you see the famous SINGER and Red "S" Trademarks. When your machine needs servicing call your SINGER CENTER to be sure of warranted SINGER parts and service. See address in the classified telephone directory.

T H E S I N G E R C O M P A N Y