



KTX-WB9214125UZZZZ

KTX

CONTRAST SENSORS

SICK
Sensor Intelligence.



Illustration may differ



Ordering information

| Type | Part no. |
|--------------------|----------|
| KTX-WB9214125UZZZZ | 1078112 |

Other models and accessories → www.sick.com/KTX

Detailed technical data

Features

| | |
|-----------------------------------|---|
| Special applications | Standard |
| Device type | Standard |
| Dimensions (W x H x D) | 30 mm x 53 mm x 78.5 mm |
| Sensing distance | ≤ 13 mm |
| Sensing distance tolerance | ± 5 mm |
| Housing design | Large |
| Light source | LED, RGB ¹⁾ |
| Wave length | 470 nm, 525 nm, 625 nm |
| Light emission | Long side of housing |
| Light spot size | 3.8 mm x 0.9 mm |
| Light spot direction | Horizontal ²⁾ |
| Receiving filters | None |
| Teach-in mode | 1-point teach-in, 2-point teach-in, teach-in dynamic, auto mode |
| Output function | Light/dark switching |
| Delay time | Adjustable |
| Special features | - |
| Delivery status | 2-point teach-in |
| Parameter presettings | None |
| Setting the key lock | Standard |

¹⁾ Average service life: 100,000 h at T_U = +25 °C.

²⁾ In relation to long side of housing.

Mechanics/electronics

| | |
|---|---|
| Supply voltage | 10.8 V DC ... 28.8 V DC ¹⁾ |
| Ripple | $\leq 5 V_{pp}$ ²⁾ |
| Current consumption | $< 100 \text{ mA}$ ³⁾ |
| Switching frequency | 50 kHz ^{4) 5)} |
| Response time | 10 μs ^{6) 7)} |
| Jitter | 5 μs ⁸⁾ |
| Switching output | Push-pull: PNP/NPN |
| Switching output (voltage) | Push-pull: PNP/NPN HIGH = $U_V - 3 \text{ V}$ /LOW $\leq 3 \text{ V}$ |
| Output current $I_{max.}$ | 100 mA ⁹⁾ |
| Input, teach-in (ET) | Teach: $U = 10 \text{ V} \dots < V_S$ |
| Input, blanking input (AT) | Blanked: $U = 10 \text{ V} \dots < U_V$ |
| Input, fine/coarse (F/C) | Coarse: $U = 10 \text{ V} \dots < U_V$ |
| Input, light/dark (L/D) | Light: $U = 10 \text{ V} \dots < U_V$ |
| Retention time (ET) | 25 ms, non-volatile memory |
| Connection type | Male connector M12, 5-pin |
| Protection class | III |
| Circuit protection | U_V connections, reverse polarity protected Output Q short-circuit protected Interference pulse suppression |
| Enclosure rating | IP67 |
| Weight | 94 g |
| Housing material | Plastic, VISTAL® |
| Optics material | Plastic, COP |

¹⁾ Limit values: DC 12 V (-10 %) ... DC 24 V (+20 %). Operation in short-circuit protected network max. 8 A.

²⁾ May not exceed or fall below U_V tolerances.

³⁾ Without load.

⁴⁾ With light/dark ratio 1:1.

⁵⁾ 1-point teach-in (color mode): 16 kHz.

⁶⁾ Signal transit time with resistive load.

⁷⁾ 1-point teach-in (color mode): 30 μs .

⁸⁾ 1-point teach-in (color mode): 15 μs .

⁹⁾ Total current of all Outputs.

Communication interface

| | |
|-----------------------|----------------------------|
| Analog | ✓, Analog output (voltage) |
| Analog output | Q _A |
| Number | 1 |
| Type | Voltage output |
| Voltage | 0 V ... 10 V |
| Digital output | Q ₁ |
| Number | 1 |
| Digital input | In ₁ |
| Number | 1 |

Ambient data

| | |
|--------------------------------------|--|
| Ambient operating temperature | -20 °C ... +60 °C |
| Ambient temperature, storage | -25 °C ... +75 °C |
| Shock load | According to IEC 60068-2-27 (30 g/11 ms) |
| UL File No. | E181493 |

Classifications

| | |
|-----------------------|----------|
| ECLASS 5.0 | 27270906 |
| ECLASS 5.1.4 | 27270906 |
| ECLASS 6.0 | 27270906 |
| ECLASS 6.2 | 27270906 |
| ECLASS 7.0 | 27270906 |
| ECLASS 8.0 | 27270906 |
| ECLASS 8.1 | 27270906 |
| ECLASS 9.0 | 27270906 |
| ECLASS 10.0 | 27270906 |
| ECLASS 11.0 | 27270906 |
| ECLASS 12.0 | 27270906 |
| ETIM 5.0 | EC001820 |
| ETIM 6.0 | EC001820 |
| ETIM 7.0 | EC001820 |
| ETIM 8.0 | EC001820 |
| UNSPSC 16.0901 | 39121528 |

Dimensional drawing (Dimensions in mm (inch))

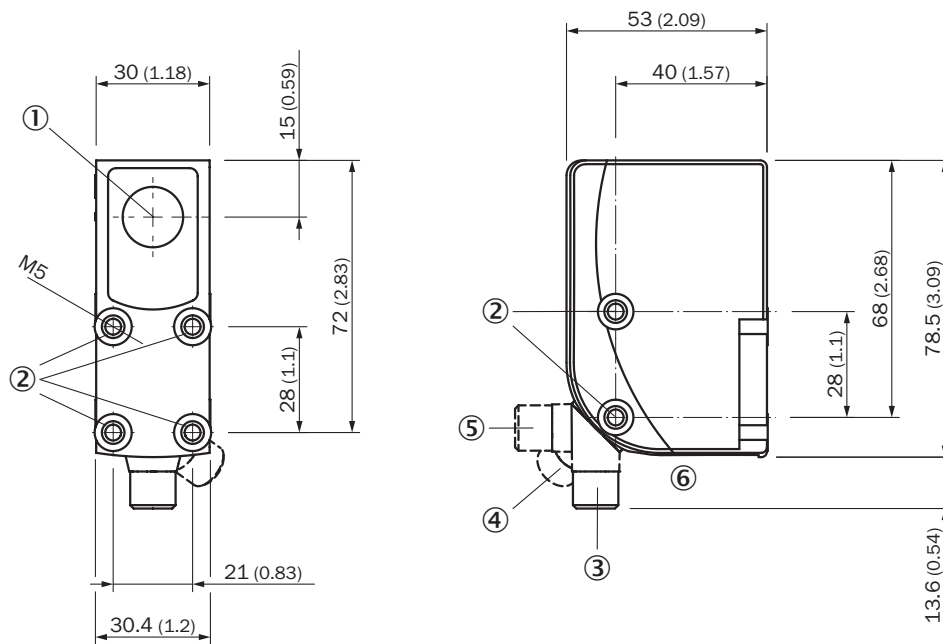

- ① Optical axis
- ② Threaded mounting hole M5
- ③ M12 male connector, delivery state
- ④ M12 male connector, end stop right
- ⑤ M12 male connector, end stop left
- ⑥ Display and adjustment elements

Adjustments

Display and adjustment elements

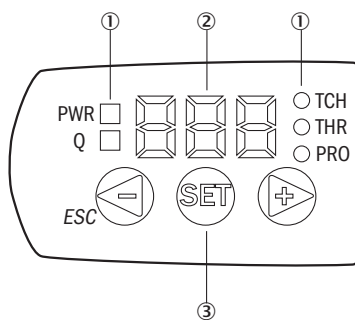

- ① LED status indicator
- ② Display
- ③ Navigation buttons

Connection diagram

Cd-385

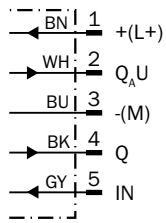

Concept of operation

KTS/KTX Prime - setting the switching threshold (2-point teach-in)

Suitable for manual positioning of the object to be detected, e.g. marks and background.

1. Position mark



When setting the contrasts to be detected, "1st" flashes. Press set button.

2. Position background



When setting the contrasts to be detected, "2nd" flashes. Press set button. The Quality of Teach is displayed.

KTS/KTX Prime - Setting the switching threshold (teach-in dynamic)

Suitable for teaching in moving objects.

1. Position background

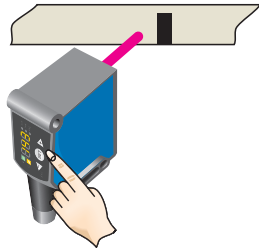

Press the Set pushbutton to start the teach-in process.

2. Move at least the mark and background using the light spot

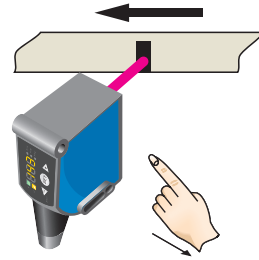

The display lights up during repeat length detection (- - -).

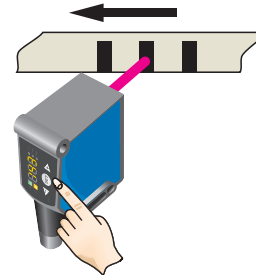

Press the Set pushbutton to end the teach-in process. The Quality of Teach is displayed.

Example

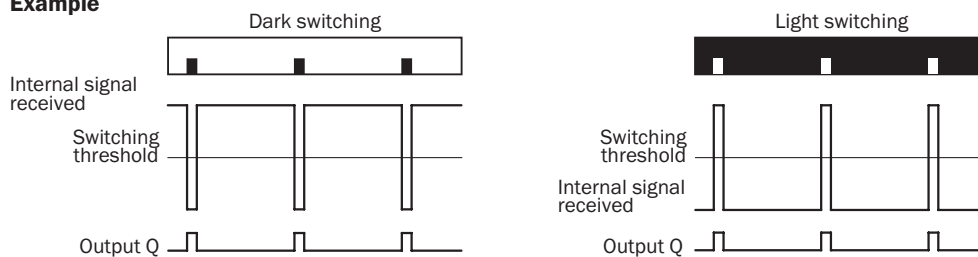

Switching characteristics

The optimum emitted light is selected automatically (at RGB variants).

Static teach-in: light/dark setting is defined using teach-in sequence.

Dynamic teach-in: switching output active on mark, if background is longer in the field of view during the teach-in.

The switching threshold is set in the center between the background and the mark.

Keylock (activation and deactivation): Press and hold the “+” pushbutton > 10 s.

The Q-LED (yellow) flashes and the “Err” error message appears on the display.



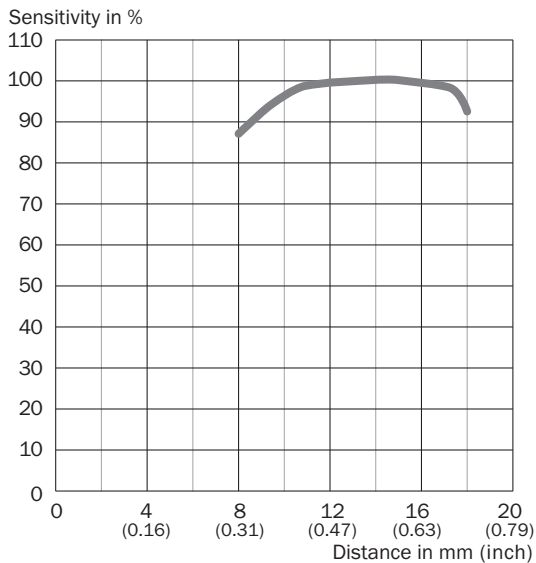

Sensing distance

Sensing distance 13 mm, light spot direction horizontal/vertical



Recommended accessories

Other models and accessories → www.sick.com/KTX

| | Brief description | Type | Part no. |
|---|--|--------------------|----------|
| Universal bar clamp systems | | | |
|  | Plate G for universal clamp bracket, steel, zinc coated, Universal clamp (2022726), mounting hardware | BEF-KHS-G01 | 2022464 |
|  | Mounting bar, straight, 200 mm, steel, steel, zinc coated, without mounting hardware | BEF-MS12G-A | 4056054 |
|  | Mounting bar, L-shaped, 150 mm x 150 mm, steel, steel, zinc coated, without mounting hardware | BEF-MS12L-A | 4056052 |
| Plug connectors and cables | | | |
|  | <ul style="list-style-type: none"> • Connection type head A: Female connector, M12, 5-pin, straight, A-coded • Connection type head B: Flying leads • Signal type: Sensor/actuator cable • Cable: 5 m, 5-wire, PVC • Description: Sensor/actuator cable, unshielded • Application: Zones with chemicals | YF2A15-050VB5XLEAX | 2096240 |
|  | <ul style="list-style-type: none"> • Connection type head A: Male connector, M12, 5-pin, straight • Description: Unshielded, Head A: male connector, M12, 5-pin, straight, unshielded, for cable diameter 4 mm ... 6 mm Head B: - • Connection systems: Screw-type terminals • Permitted cross-section: ≤ 0.75 mm² • Note: For field bus technology | STE-1205-G | 6022083 |

SICK AT A GLANCE

SICK is one of the leading manufacturers of intelligent sensors and sensor solutions for industrial applications. A unique range of products and services creates the perfect basis for controlling processes securely and efficiently, protecting individuals from accidents and preventing damage to the environment.

We have extensive experience in a wide range of industries and understand their processes and requirements. With intelligent sensors, we can deliver exactly what our customers need. In application centers in Europe, Asia and North America, system solutions are tested and optimized in accordance with customer specifications. All this makes us a reliable supplier and development partner.

Comprehensive services complete our offering: SICK LifeTime Services provide support throughout the machine life cycle and ensure safety and productivity.

For us, that is “Sensor Intelligence.”

WORLDWIDE PRESENCE:

Contacts and other locations –www.sick.com