

Part number

COB 10 CMS



Insulating insert carrier enclosure for mobile mounting, COB panel supports series, side cable entry with cable clamp, for inserts with 57 x 27 mm screw fixing centre distance

Product description

Product type	Insulating insert carrier enclosure for mobile mounting
Series	COB panel supports
Cable entry	Side cable entry with cable clamp
Specification	For inserts with 57 x 27 mm screw fixing centre distance

Technical data

IP degree of protection	IP20
--------------------------------	------

Further technical details

Weight	70,00 g
Operating temperature range (min, max)	-40°C...+125°C

Material properties

Colour	RAL 7032 grey
RoHs conformity	Compliant with exemption 6(c): copper alloy containing up to 4% lead by weight
China RoHs - EFUP	50
REACH SVHC substances	Yes Lead
SCIP number	B008b8e4-629e-4e70-ab7d-b3b67464925d

Approvals / Standards

Certifications	DNV, BV
UL	ECBT2
cUL	ECBT8

General ordering information

EAN13 code	8015747036559
eCl@ss 8.1	27440202
ETIM 7.0	EC000437

Packaging Information

Packaging length	225,00 mm
Packaging height	120,00 mm
Packaging width	135,00 mm
Packaging weight	0,70 kg
Packaging volume	3,65 dm ³
Packaging description	Carton box
Packaging quantity	10 Pcs
Packaging EAN code	8015747036566
Sub-packaging weight	0,07 kg
Sub-packaging description	Carton tray
Sub-packaging quantity	1 Pcs
Sub-packaging EAN barcode	8015747036573

Part number

COB 10 CMS



Catalogue drawings

COB..CMS

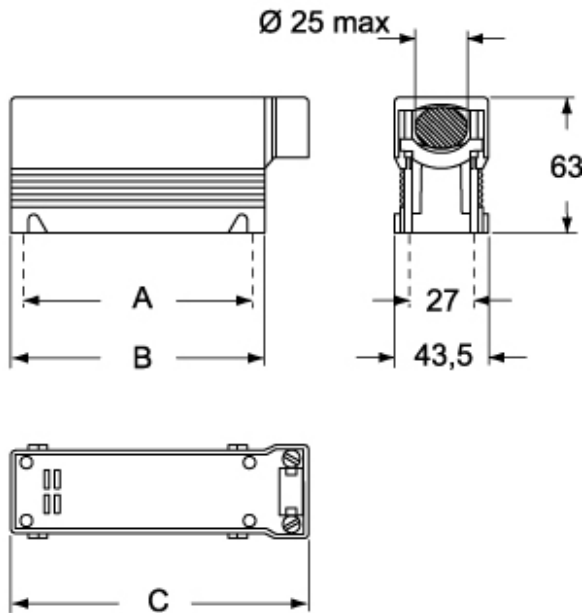

Notes

Dimensions shown in mm are not binding and may be changed without notice.