

# Frame Square/Wall Frame Square Maxi



**CE IP66 IK10**

220-240V, 50/60Hz (Sensor 50Hz)

NO: Skru av strømmen før montering  
 EN: Turn off power before installing  
 FR: Couper le courant avant l'installation  
 NL: Stroom uitschakelen voor u het toestel installeert  
 DE: Vor Installationsarbeiten den Strom abschalten.  
 FI: Sammuta virta ennen kytkemistä.

● 0,5 - 1,0 mm<sup>2</sup> 8 mm

● 1,5 - 2,5 mm<sup>2</sup> 12 mm

ca 10° (max. 20°)  
Max 16 A



NO: Kan kun installeres av en registrert installasjonsvirksomhet  
 EN: Only to be installed by an authorized electrician  
 FR: Doit être installé par un électricien autorisé  
 NL: Mag alleen geïnstalleerd worden door een bevoegde elektricien  
 DE: Dieses Produkt darf nur durch autorisiertes Personal (z. B. Elektro-Installateur) angeschlossen und in Betrieb genommen werden.  
 FI: Asentaa saa vain valtuutettu sähköasentaja.

Frame Square/Wall

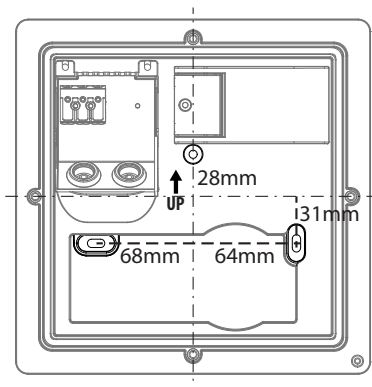

Frame Square Maxi

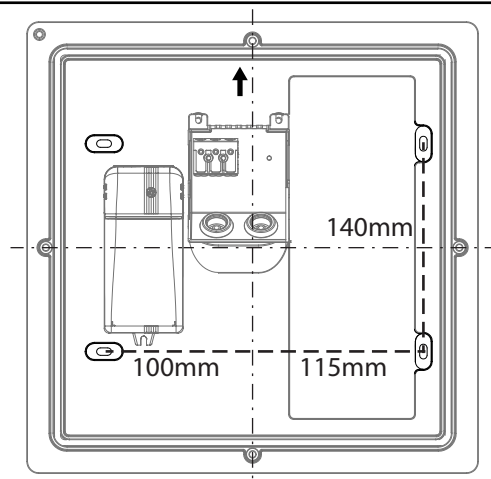

**CORPORATE OFFICE:**  
**SG Armaturen AS**  
 Skytterheia 25  
 4790 Lillesand  
 NORGE

**BRANCH OFFICE:**  
 SG Lighting SA/NV  
 Blokhuisstraat 47  
 2800 Mechelen Noord I  
 BELGIQUE/BELGIË

**BRANCH OFFICE:**  
 SG Armaturen A/S  
 Egebakken 19  
 7400 Herning  
 DANMARK

**BRANCH OFFICE:**  
 SG Lighting SA/NV  
 73 rue de Saint Mandrier  
 83140 Six Fours Les Plages  
 FRANCE

**BRANCH OFFICE:**  
 SG Leuchten GmbH  
 Postfach 67 04 21  
 22344 Hamburg  
 GERMANY

**BRANCH OFFICE:**  
 SG Armaturen AB  
 August Barksg. 30B  
 421 32 Västra Frölunda  
 SVERIGE

Tlf:+47 37 50 03 00  
 firmapost@sg-as.no  
 www.sg-as.no

Tlf:+32(0) 15 20 72 71  
 info.benelux@silighting.net  
 www.silighting.net

Tlf:+45 70 70 72 13  
 info@sg-as.dk  
 www.sg-as.dk

Tlf:+33(0) 4 94 93 00 00  
 info.france@silighting.fr  
 www.silighting.net



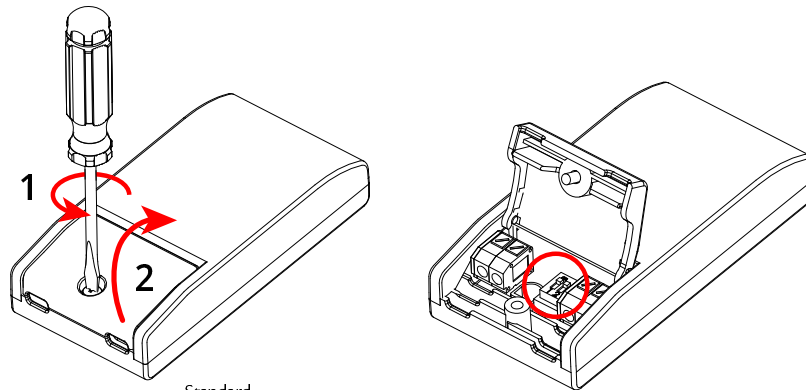

Tlf:+49 40 23 99 44 59  
 info@sg-leuchten.de  
 www.sg-leuchten.de

Tlf:+46 31 81 71 10  
 info@sg-ab.se  
 www.sg-ab.se

Frame  
Square/Wall







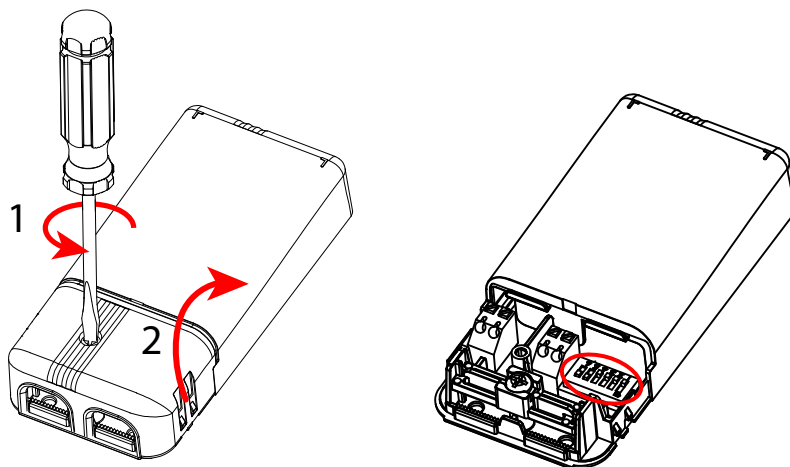

Standard

				
mA	<b>180</b>	205	230	255
W	<b>5,8</b>	6,6	7,5	8,3
lm	<b>100%</b>	114%	130%	140%

Frame  
Square  
Maxi



Standard

							
mA	250	300	350	400	450	500	<b>550</b>
W	10	12	14	16	18	20	<b>22</b>
lm	45%	55%	64%	73%	82%	90%	<b>100%</b>

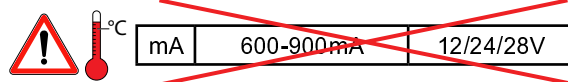

# HC009S sensor



230V, 50Hz

40-60%

60-80%

0-10%

0%

80-90%

Standby power		< 0.5W
Microwave frequency		5.8GHz+/-75MHz
Microwave power		< 0.2mW

	1	2	3	
I	●	●	●	100%
II	○	●	●	75%
III	●	○	●	50%
IV	●	●	○	25%
V	○	○	○	10%

	1	2	3	4	
I	●	●	●	●	5s
II	○	●	●	●	30s
III	●	○	●	●	1min
IV	●	●	○	●	5min
V	●	●	●	○	15min
VI	○	○	○	○	30min

	1	2	3	4	
I	●	●	●	●	2 Lux
II	○	●	●	●	5 Lux
III	●	○	●	●	10 Lux
IV	●	●	○	●	30 Lux
V	●	●	●	○	50 Lux
VI	○	○	○	○	Disable

ceiling mounting height (m)

ceiling mounting pattern (m)

wall mounting height

wall mounting pattern (m)

Max 400W

Sensor:

Sensor + Basic light:

<p><b>CORPORATE OFFICE:</b>  <b>SG Armaturen AS</b>                  Skytterheia 25                  4790 Lillesand                  NORGE</p> <p>Tlf:+47 37 50 03 00                  firmapost@sg-as.no                  www.sg-as.no</p>	<p><b>BRANCH OFFICE:</b>                  SG Lighting SA/NV                  Blokhuisstraat 47                  2800 Mechelen Noord I                  BELGIQUE/BELGIË</p> <p>Tlf:+32(0) 15 20 72 71                  info.benelux@sglighting.net                  www.sglighting.net</p>	<p><b>BRANCH OFFICE:</b>                  SG Armaturen A/S                  Egebakken 19                  7400 Herning                  DANMARK</p> <p>Tlf:+45 70 70 72 13                  info@sg-as.dk                  www.sg-as.dk</p>	<p><b>BRANCH OFFICE:</b>                  SG Lighting SA/NV                  73 rue de Saint Mandrier                  83140 Six Fours Les Plages                  FRANCE</p> <p>Tlf:+33(0) 4 94 93 00 00                  info.france@sglighting.fr                  www.sglighting.net</p>	<p><b>BRANCH OFFICE:</b>                  SG Leuchten GmbH                  Nordstrasse 53                  59399 Olfen                  GERMANY</p> <p>Tlf:+49 2595 3870 725                  info@sg-leuchten.de                  www.sg-leuchten.de</p>	<p><b>BRANCH OFFICE:</b>                  SG Armaturen AB                  August Barksg. 30B                  421 32 Västra Frölunda                  SVERIGE</p> <p>Tlf:+46 31 81 71 10                  info@sg-ab.se                  www.sg-ab.se</p>
---	---	---	--	--	--

Rev: 11.10.2017

# Twilight sensor





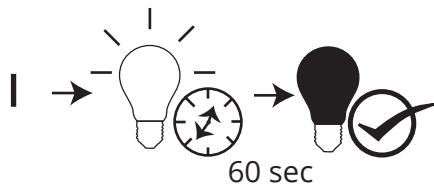



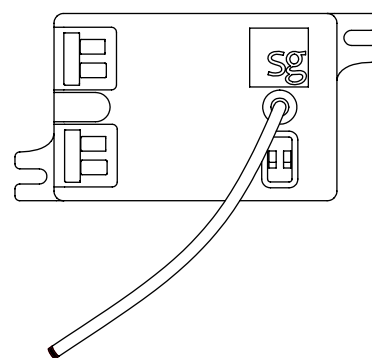
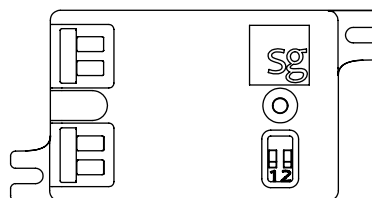

230V, 50/60Hz



	< 0,5 W
Max.	200 W

IR	
<del>IR</del>	LED



		SWITCH		SENSOR		
		S1	S2	Sensor LUX Level	Open (LUX)	Close (LUX)
Standard		ON	ON		100	150
		ON	OFF		80	130
		OFF	ON		70	120
		OFF	OFF		50	100

Rev: 12.01.2018

**NORWAY** SG Armaturen AS  
Tlf: +47 37 50 03 00  
firmapost@sg-as.no  
www.sg-as.no

**SWEDEN** SG Armaturen AB  
Tel: +46 31 81 71 10  
info@sg-ab.se  
www.sg-ab.se

**FRANCE** SG Lighting SA/NV  
Tel: +33(0) 4 94 93 00 00  
info.france@sglighting.fr  
www.sglighting.net

**GERMANY** SG Leuchten GmbH  
Tel: +49 40 23 99 44 59  
info@sg-leuchten.de  
www.sg-leuchten.de

**DENMARK** SG Armaturen A/S  
Tel: +45 70 70 72 13  
info@sg-as.dk  
www.sg-as.dk

**FINLAND** SG Armaturen Oy  
info@sg-oy.fi  
www.sg-oy.fi

**BENELUX** SG Lighting SA/NV  
Tel: +32(0) 15 20 72 71  
info.benelux@sglighting.net  
www.sglighting.net

**INTERNATIONAL** SG Lighting Co Ltd.  
Tel: +86 769 88 49 20 88  
cindy@sgdgc.com  
www.sg-as.com