

Part number

# CR 25 AD1

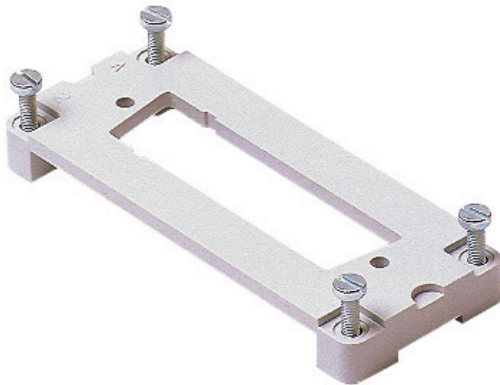

Adapter plate, size "57.27", for one 25 poles D-SUB insert

#### Product description

<b>Product type</b>	Adapter plate
<b>Size</b>	Size 57.27
<b>Specification</b>	For one 25 poles D-SUB insert

#### Further technical details

<b>Weight</b>	7,00 g
---------------	--------

#### General ordering information

<b>EAN13 code</b>	8015747037723
<b>eCl@ss 8.1</b>	27440201
<b>ETIM 7.0</b>	EC002309

#### Packaging Information

<b>Sub-packaging weight</b>	0,07 kg
<b>Sub-packaging description</b>	Carton box
<b>Sub-packaging quantity</b>	10 Pcs
<b>Sub-packaging EAN barcode</b>	8015747037730

Part number

# CR 25 AD1



## Catalogue drawings

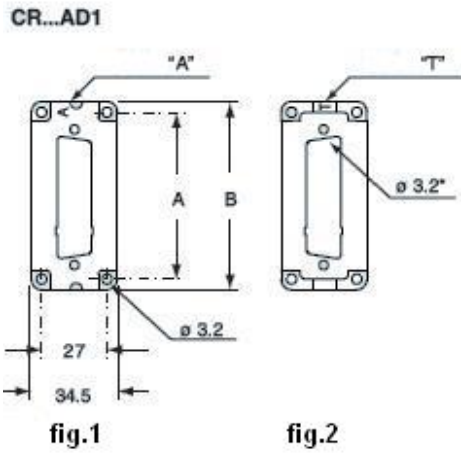

## Notes

The electrical continuity is guaranteed only if mounted in our enclosures.

Dimensions shown in mm are not binding and may be changed without notice.