



Product designation				Power contactor
Product type designation				BF18
Contact characteristics				
Number of poles	Nr.			4
Rated insulation voltage U _i IEC/EN	V			690
Rated impulse withstand voltage U _{imp}	kV			6
Operational frequency	min	Hz		25
	max	Hz		400
IEC Conventional free air thermal current I _{th}	A			32
Operational current I _e	AC-1 (≤40°C)	A		32
	AC-1 (≤55°C)	A		26
	AC-1 (≤70°C)	A		23
	AC-3 (≤440V ≤55°C)	A		18
	AC-4 (400V)	A		8.5
Rated operational power AC-1 (T≤40°C)	230V	kW		12
	400V	kW		21
	500V	kW		26
	690V	kW		36
Short-time allowable current for 10s (IEC/EN60947-1)	A			200
Protection fuse	gG (IEC)	A		32
	aM (IEC)	A		20
Making capacity (RMS value)	A			180
Breaking capacity at voltage	440V	A		144
	500V	A		120
	690V	A		94
Resistance per pole (average value)	mΩ			2.5
Power dissipation per pole (average value)	I _{th}	W		2.6
	AC-3	W		0.8
Tightening torque for terminals	min	Nm		1.5
	max	Nm		1.8
	min	lbin		1.1
	max	lbin		1.5
Tightening torque for coil terminal	min	Nm		0.8
	max	Nm		1
	min	lbin		0.8
	max	lbin		0.74
Max number of wires simultaneously connectable	Nr.			2

Conductor section			
AWG/Kcmil		max	10
Flexible w/o lug conductor section			
		min	mm ² 1
		max	mm ² 6
Flexible c/w lug conductor section			
		min	mm ² 1
		max	mm ² 4
Flexible with insulated spade lug conductor section			
		min	mm ² 1
		max	mm ² 4
Power terminal protection according to IEC/EN 60529			IP20 when properly wired
Mechanical features			
Operating position			
		normal allowable	Vertical plan ±30°
Fixing			Screw / DIN rail 35mm
Weight			g 500
Conductor section			
AWG/kcmil conductor section		max	10
Operations			
Mechanical life		cycles	20000000
Electrical life		cycles	1600000
Safety related data			
Performance level B10d according to EN/ISO 13489-1			
		rated load	cycles 1600000
		mechanical load	cycles 20000000
Mirror contacts according to IEC/EN 60947-4-1			YES
EMC compatibility			yes
DC coil operating			
DC rated control voltage		V	48
DC operating voltage			
pick-up		min	%Us 70
		max	%Us 125
drop-out		min	%Us 10
		max	%Us 40
Average coil consumption ≤20°C			
		in-rush	W 5.4
		holding	W 5.4
Max cycles frequency			
Mechanical operation		cycles/h	3600
Operating times			
Average time for Us control			
in AC		Closing NO	
		min	ms 8
		max	ms 24

Opening NO	min	ms	10
	max	ms	20
Closing NC	min	ms	14
	max	ms	28
Opening NC	min	ms	7
	max	ms	18
<hr/>			
in DC			
Closing NO	min	ms	54
	max	ms	66
Opening NO	min	ms	14
	max	ms	17
Closing NC	min	ms	24
	max	ms	30
Opening NC	min	ms	47
	max	ms	57

UL technical data

Full-load current (FLA) for three-phase AC motor

at 480V	A	14
at 600V	A	17

Yielded mechanical performance

for single-phase AC motor

110/120V	HP	1
230V	HP	3

for three-phase AC motor

200/208V	HP	5
220/230V	HP	5
460/480V	HP	10
575/600V	HP	15

General USE

Contactor

AC current	A	32
------------	---	----

Ambient conditions

Temperature

Operating temperature

min	°C	-50
max	°C	70

Storage temperature

min	°C	-60
max	°C	80

Max altitude

m	3000
---	------

Resistance & Protection

Pollution degree

3

Dimensions

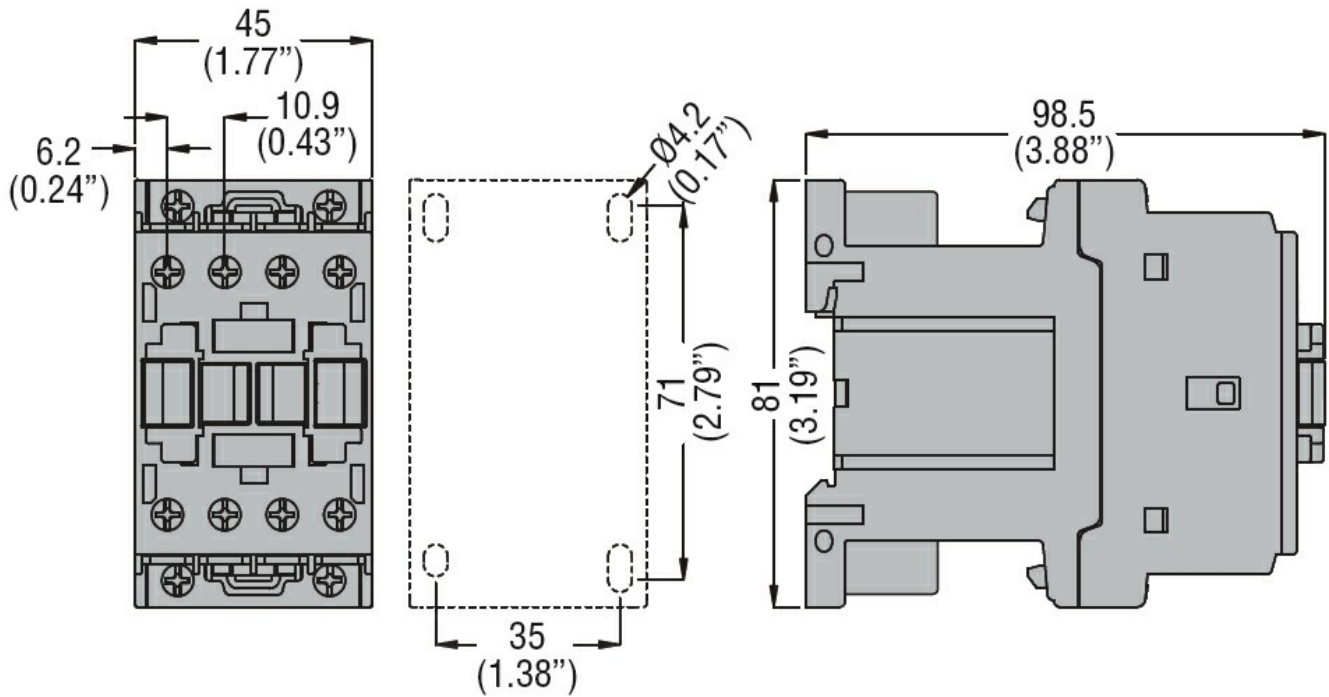

Wiring diagrams

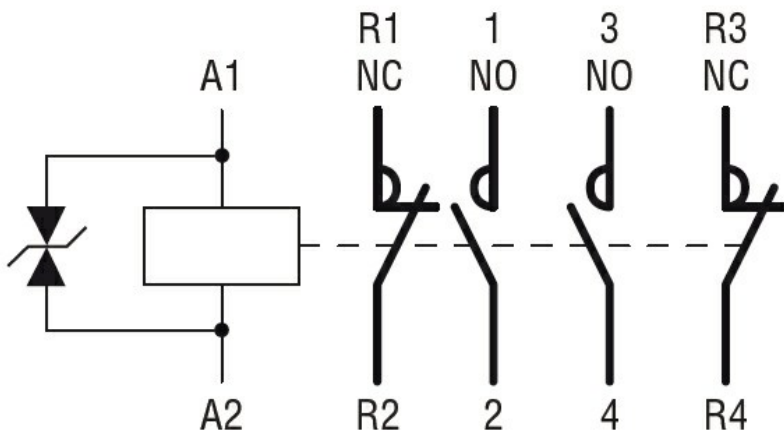

Certifications and compliance

Compliance

CSA C22.2 n° 60947-1
CSA C22.2 n° 60947-4-1
IEC/EN/BS 60947-1
IEC/EN/BS 60947-4-1
UL 60947-1
UL 60947-4-1

Certificates

CCC
cULus
EAC

ETIM classification

ETIM 8.0

EC000066 -
Power contactor,
AC switching