

Class 1
 E27

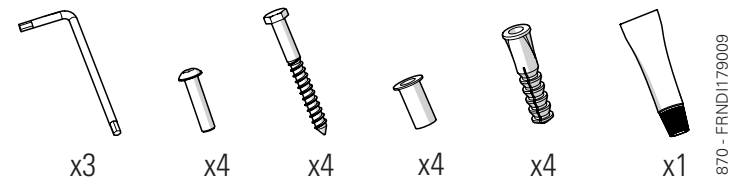

870 - FRND1179009

1 Fixation de la base au sol Fix the mast base to the ground

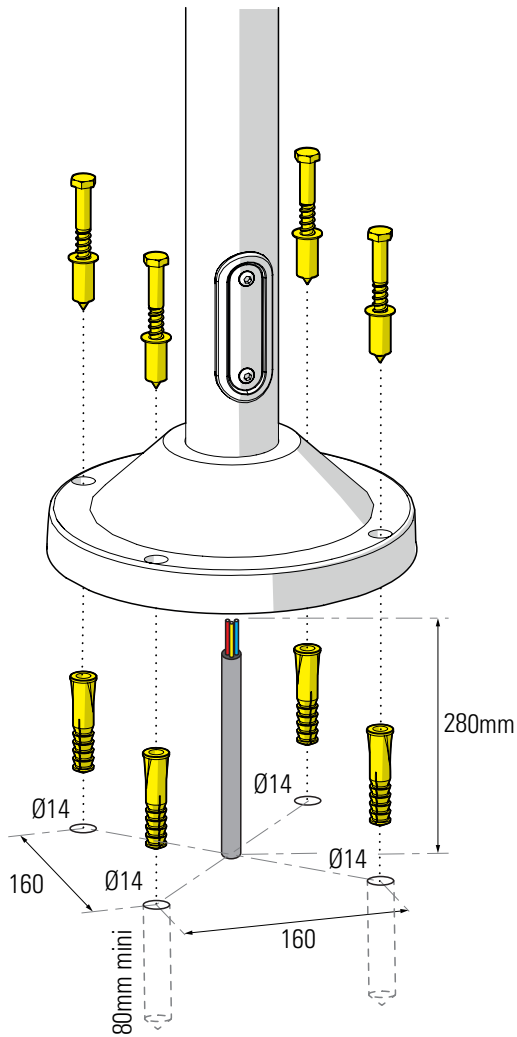

2 Montage des bras Assemble the brackets

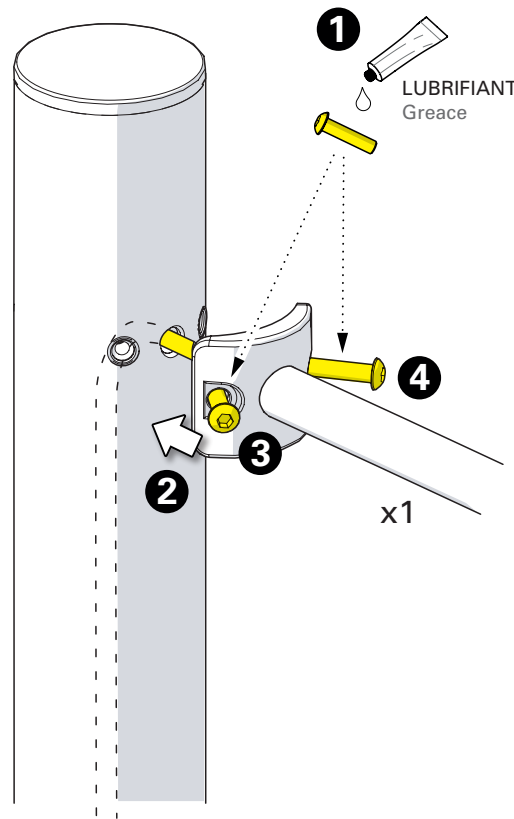

3 Raccordement électrique Connect electrical wires

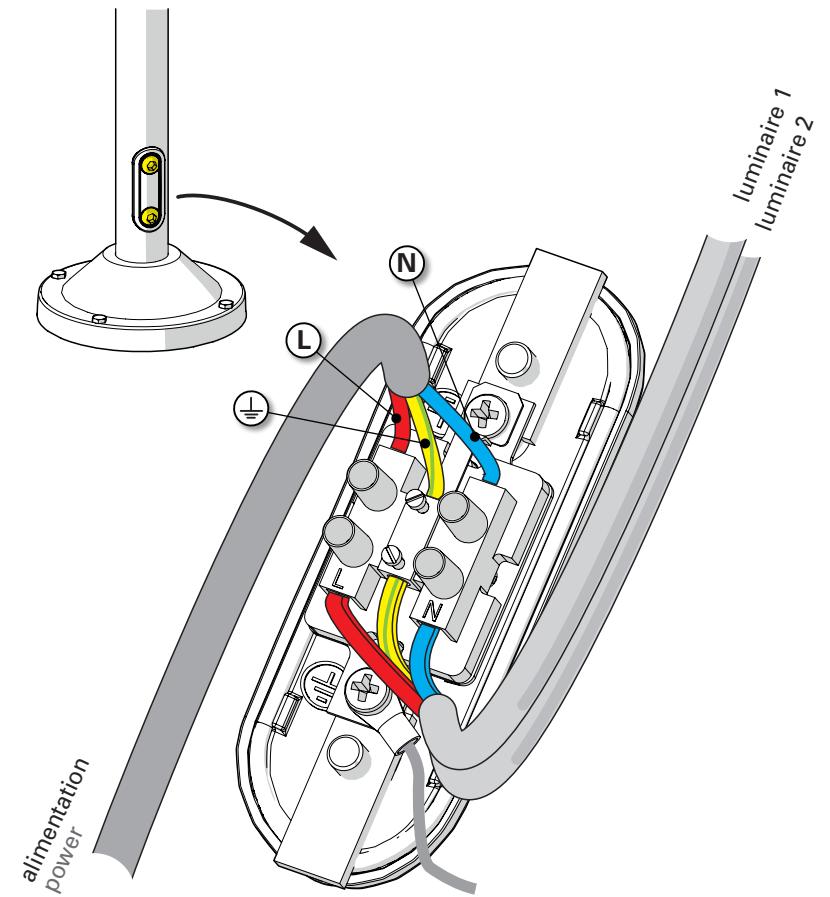

4 Montage de la lampe
Install the light-bulb

