



WSE4SLC-3P2236A00

W4

MINIATURE PHOTOELECTRIC SENSORS

**SICK**  
Sensor Intelligence.



Illustration may differ

### Ordering information

| Type              | Part no. |
|-------------------|----------|
| WSE4SLC-3P2236A00 | 1080957  |

Other models and accessories → [www.sick.com/W4](http://www.sick.com/W4)



### Detailed technical data

#### Features

|   |  |
|---|--|
| <b>Functional principle</b>                 | Through-beam photoelectric sensor  |
| <b>Sensing range max.</b>                   | 0 m ... 60 m   |
| <b>Sensing range</b>                        | 0 m ... 50 m   |
| <b>Emitted beam</b>                         |  |
| Light source                                | Laser <sup>1)</sup>  |
| Type of light                               | Visible red light  |
| Light spot size (distance)                  | Ø 1 mm (500 mm)  |
| <b>Key laser figures</b>                    |  |
| Normative reference                         | EN 60825-1:2014, IEC 60825-1:2014 / CDRH 21 CFR 1040.10 & 1040.11              |
| Laser class                                 | 1  |
| Wave length                                 | 650 nm   |
| <b>Adjustment</b>                           | IO-Link  |
| <b>Special applications</b>                 | Detecting small objects  |
| <b>Part number of individual components</b> | 2064095 WS4SL-3D2236, 2088186 WE4SLC-3P2230A00                                 |
| <b>Mounting hole</b>                        | M3   |
| <b>Pin 2 configuration</b>                  | External input, Detection output, logic output, alarm output operating reserve |

<sup>1)</sup> Average service life: 50,000 h at T<sub>U</sub> = +25 °C.

## Safety-related parameters

|                                     |  |
|-------------------------------------|--|
| <b>MTTF<sub>D</sub></b>             | 405 years (EN ISO 13849-1) <sup>1)</sup> |
| <b>DC<sub>avg</sub></b>             | 0 %                                      |
| <b>T<sub>M</sub> (mission time)</b> | 10 years                                 |

<sup>1)</sup> Mode of calculation: Parts-Count-calculation.

## Communication interface

|                        |  |
|------------------------|--|
| <b>IO-Link</b>         | ✓, COM2 (38,4 kBaud)   |
| Data transmission rate | COM2 (38,4 kBaud)  |
| Cycle time             | 2.3 ms   |
| Process data length    | 16 Bit   |
| Process data structure | Bit 0 = switching signal Q <sub>L1</sub><br>Bit 1 = switching signal Q <sub>L2</sub><br>Bit 2 ... 15 = empty |
| VendorID               | 26   |
| DeviceID HEX           | 0x80011B   |
| DeviceID DEC           | 8388891  |

## Electrical data

|                                     |   |
|-------------------------------------|---|
| <b>Supply voltage U<sub>B</sub></b> | 10 V DC ... 30 V DC <sup>1)</sup>                       |
| <b>Ripple</b>                       | < 5 V <sub>pp</sub> <sup>2)</sup>                       |
| <b>Current consumption</b>          | 30 mA <sup>3)</sup>                                     |
| <b>Protection class</b>             | III   |
| <b>Digital output</b>               |   |
| Type                                | PNP <sup>4) 5)</sup>                                    |
| Switching mode                      | Light/dark switching <sup>4)</sup>                      |
| Output current I <sub>max</sub>     | ≤ 100 mA  |
| Response time                       | ≤ 0.5 ms <sup>6)</sup>                                  |
| Repeatability (response time)       | 150 μs <sup>7)</sup>                                    |
| Switching frequency                 | 1,000 Hz <sup>8)</sup>                                  |
| <b>Output function</b>              | Complementary   |
| <b>Circuit protection</b>           | A <sup>9)</sup><br>B <sup>10)</sup><br>C <sup>11)</sup> |

<sup>1)</sup> Limit values when operated in short-circuit protected network: max. 8 A.

<sup>2)</sup> May not exceed or fall below U<sub>v</sub> tolerances.

<sup>3)</sup> Without load.

<sup>4)</sup> Q = light switching.

<sup>5)</sup> Pin 4: This switching output must not be connected to another output.

<sup>6)</sup> Signal transit time with resistive load.

<sup>7)</sup> Valid for Q \ on Pin2, if configured with software.

<sup>8)</sup> With light/dark ratio 1:1.

<sup>9)</sup> A = V<sub>S</sub> connections reverse-polarity protected.

<sup>10)</sup> B = inputs and output reverse-polarity protected.

<sup>11)</sup> C = interference suppression.

<sup>12)</sup> With light / dark ratio 1:1, valid for Q \ on Pin2, if configured with software.

|   |                         |
|---|-------------------------|
| <b>Switching frequency Q / to pin 2</b> | 1,000 Hz <sup>12)</sup> |
|---|-------------------------|

- 1) Limit values when operated in short-circuit protected network: max. 8 A.
- 2) May not exceed or fall below  $U_V$  tolerances.
- 3) Without load.
- 4) Q = light switching.
- 5) Pin 4: This switching output must not be connected to another output.
- 6) Signal transit time with resistive load.
- 7) Valid for Q \ on Pin2, if configured with software.
- 8) With light/dark ratio 1:1.
- 9) A =  $V_S$  connections reverse-polarity protected.
- 10) B = inputs and output reverse-polarity protected.
- 11) C = interference suppression.
- 12) With light / dark ratio 1:1, valid for Q \ on Pin2, if configured with software.

### Mechanical data

|                               |                             |
|-------------------------------|-----------------------------|
| <b>Housing</b>                | Rectangular                 |
| <b>Design detail</b>          | Slim                        |
| <b>Dimensions (W x H x D)</b> | 12.2 mm x 41.8 mm x 17.3 mm |
| <b>Connection</b>             | Male connector M8, 4-pin    |
| <b>Material</b>               |                             |
| Housing                       | Plastic, Novodur            |
| Front screen                  | Plastic, PMMA               |
| <b>Weight</b>                 | 100 g                       |

### Ambient data

|   |                                    |
|---|------------------------------------|
| <b>Enclosure rating</b>                       | IP66<br>IP67                       |
| <b>Ambient operating temperature</b>          | -10 °C ... +50 °C                  |
| <b>Ambient operating temperature extended</b> | -30 °C ... +55 °C <sup>1) 2)</sup> |
| <b>Ambient temperature, storage</b>           | -30 °C ... +70 °C                  |

- 1) As of  $T_a = 50$  °C, a max. supply voltage  $V_{max} = 24$  V and a max. load current  $I_{max} = 50$  mA is permitted.
- 2) Operation below  $T_u -10$  °C is possible if the sensor is already switched on at  $T_u > -10$  °C, then cools down, and the supply voltage is subsequently not switched off. Switching on below  $T_u -10$  °C is not permissible.

### Smart Task

|                            |  |
|----------------------------|--|
| <b>Smart Task name</b>     | Base logics  |
| <b>Logic function</b>      | Direct<br>AND<br>OR<br>Hysteresis  |
| <b>Timer function</b>      | Deactivated<br>On delay<br>Off delay<br>ON and OFF delay<br>Impulse (one shot) |
| <b>Inverter</b>            | Yes  |
| <b>Switching frequency</b> | SIO Direct: 1000 Hz <sup>1)</sup>  |

- 1) SIO Direct: sensor operation in standard I/O mode without IO-Link communication and without using internal sensor logic or time parameters (set to "direct"/"deactivated").
- 2) SIO Logic: Sensor operation in standard I/O mode without IO-Link communication. Sensor-internal logic or timing parameters plus Automation Functions used.
- 3) IOL: Sensor operation with full IO-Link communication and usage of logic, timing and Automation Function parameters.

|                                  |   |
|----------------------------------|---|
|                                  | SIO Logic: 1000 Hz <sup>2)</sup><br>IOL: 900 Hz <sup>3)</sup>   |
| <b>Response time</b>             | SIO Direct: 300 µs ... 450 µs <sup>1)</sup><br>SIO Logic: 500 µs ... 600 µs <sup>2)</sup><br>IOL: 500 µs ... 900 µs <sup>3)</sup> |
| <b>Repeatability</b>             | SIO Direct: 150 µs <sup>1)</sup><br>SIO Logic: 150 µs <sup>2)</sup><br>IOL: 400 µs <sup>3)</sup>                                  |
| <b>Switching signal</b>          |   |
| Switching signal Q <sub>L1</sub> | Switching output  |
| Switching signal Q <sub>L2</sub> | Switching output  |

<sup>1)</sup> SIO Direct: sensor operation in standard I/O mode without IO-Link communication and without using internal sensor logic or time parameters (set to "direct"/"deactivated").

<sup>2)</sup> SIO Logic: Sensor operation in standard I/O mode without IO-Link communication. Sensor-internal logic or timing parameters plus Automation Functions used.

<sup>3)</sup> IOL: Sensor operation with full IO-Link communication and usage of logic, timing and Automation Function parameters.

### Diagnosis

|                         |     |
|-------------------------|-----|
| <b>Device status</b>    | Yes |
| <b>Function reserve</b> | Yes |

### Classifications

|                       |          |
|-----------------------|----------|
| <b>ECLASS 5.0</b>     | 27270901 |
| <b>ECLASS 5.1.4</b>   | 27270901 |
| <b>ECLASS 6.0</b>     | 27270901 |
| <b>ECLASS 6.2</b>     | 27270901 |
| <b>ECLASS 7.0</b>     | 27270901 |
| <b>ECLASS 8.0</b>     | 27270901 |
| <b>ECLASS 8.1</b>     | 27270901 |
| <b>ECLASS 9.0</b>     | 27270901 |
| <b>ECLASS 10.0</b>    | 27270901 |
| <b>ECLASS 11.0</b>    | 27270901 |
| <b>ECLASS 12.0</b>    | 27270901 |
| <b>ETIM 5.0</b>       | EC002716 |
| <b>ETIM 6.0</b>       | EC002716 |
| <b>ETIM 7.0</b>       | EC002716 |
| <b>ETIM 8.0</b>       | EC002716 |
| <b>UNSPSC 16.0901</b> | 39121528 |

Connection diagram

Cd-376

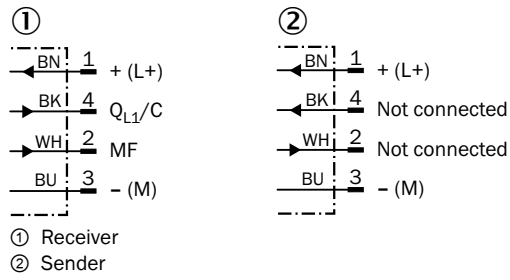

Characteristic curve

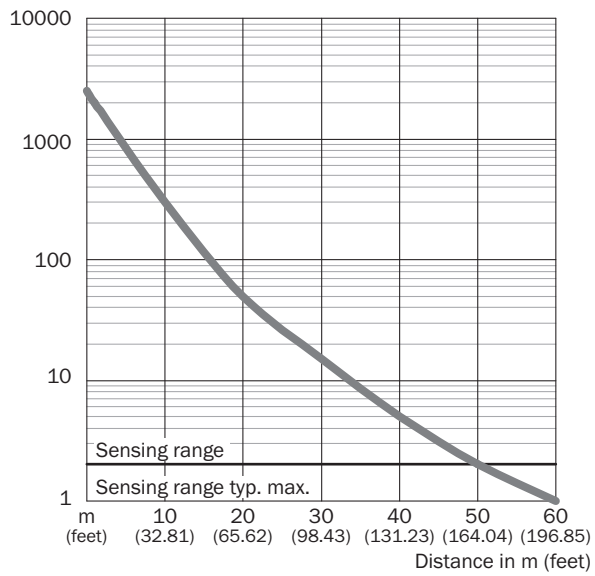

### Light spot size

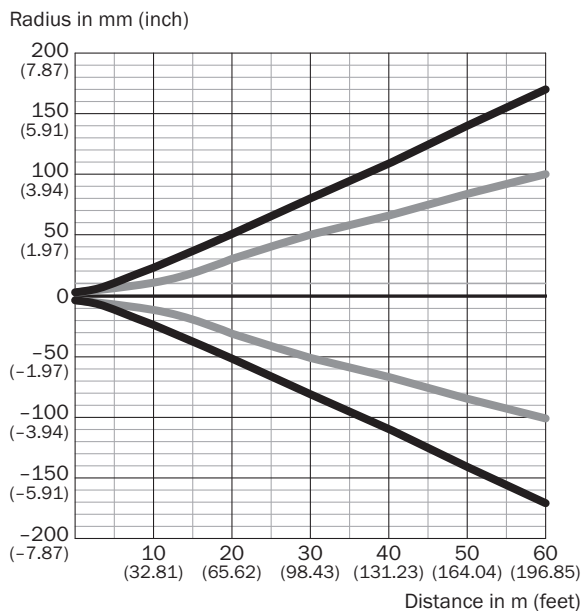

#### Dimensions in mm (inch)

| Sensing range                | Vertical        | Horizontal      |
|------------------------------|-----------------|-----------------|
| <b>0.5 m</b><br>(1.64 feet)  | < 1.0<br>(0.04) | < 1.0<br>(0.04) |
| <b>1 m</b><br>(3.28 feet)    | 1.5<br>(0.06)   | 1.2<br>(0.05)   |
| <b>5 m</b><br>(16.40 feet)   | 15<br>(0.59)    | 11<br>(0.43)    |
| <b>10 m</b><br>(32.81 feet)  | 45<br>(1.77)    | 28<br>(1.10)    |
| <b>60 m</b><br>(196.85 feet) | 336<br>(13.23)  | 200<br>(7.87)   |

— Vertical  
 — Horizontal

### Light spot size (detailed view)

Detailed view close range

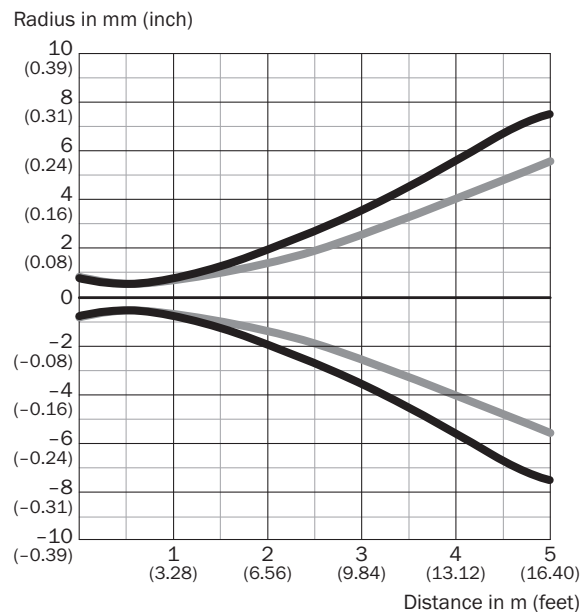

— Vertical  
 — Horizontal

### Sensing range diagram

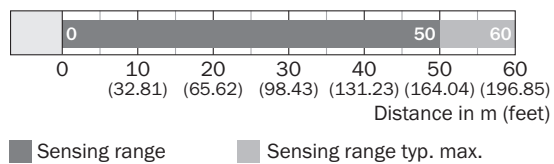

### Dimensional drawing (Dimensions in mm (inch))

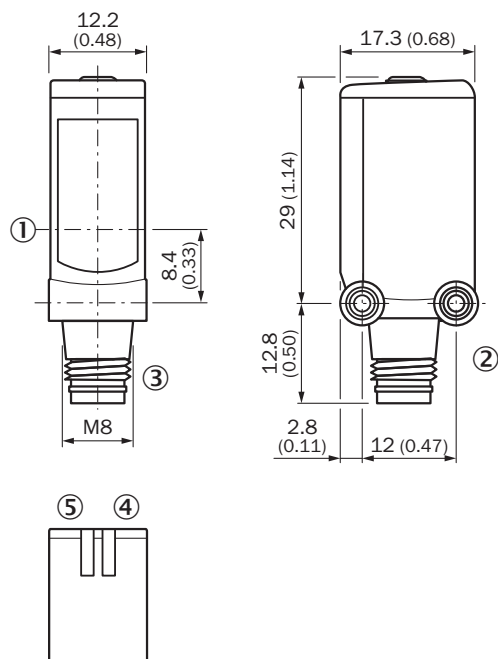

- ① Center of optical axis
- ② Threaded mounting hole M3
- ③ Connection
- ④ LED indicator green: Supply voltage active
- ⑤ LED indicator yellow: Status of received light beam

### Recommended accessories

Other models and accessories → [www.sick.com/W4](http://www.sick.com/W4)

|   | Brief description   | Type       | Part no. |
|---|---|------------|----------|
| Plug connectors and cables  |   |            |          |
|  | <ul style="list-style-type: none"> <li>• <b>Connection type head A:</b> Male connector, M8, 4-pin, straight</li> <li>• <b>Description:</b> Unshielded</li> <li>• <b>Connection systems:</b> Screw-type terminals</li> <li>• <b>Permitted cross-section:</b> 0.14 mm<sup>2</sup> ... 0.5 mm<sup>2</sup></li> </ul> | STE-0804-G | 6037323  |



|   | Brief description  | Type               | Part no. |
|---|--|--------------------|----------|
| Others  |  |                    |          |
|  | <ul style="list-style-type: none"> <li>• <b>Connection type head A:</b> Female connector, M8, 4-pin, straight, A-coded</li> <li>• <b>Connection type head B:</b> Flying leads</li> <li>• <b>Signal type:</b> Sensor/actuator cable</li> <li>• <b>Cable:</b> 5 m, 4-wire, PVC</li> <li>• <b>Description:</b> Sensor/actuator cable, unshielded</li> <li>• <b>Application:</b> Zones with chemicals</li> </ul> | YF8U14-050VA3XLEAX | 2095889  |

### Recommended services

Additional services → [www.sick.com/W4](http://www.sick.com/W4)

|  | Type                   | Part no.   |
|--|------------------------|------------|
| Function Block Factory   |                        |            |
| <ul style="list-style-type: none"> <li>• <b>Description:</b> The Function Block Factory supports common programmable logic controllers (PLCs) from various manufacturers, such as Siemens, Beckhoff, Rockwell Automation and B&amp;R. More information on the FBF can be found <a _blank"="" href="https://fbf.cloud.sick.com target=">here</a>.</li> <li>• <b>Note:</b> You can configure your function block at <a _blank"="" href="https://fbf.cloud.sick.com target=">Function Block Factory</a>. As a login please use your SICK ID.</li> </ul> | Function Block Factory | On request |

## SICK AT A GLANCE

SICK is one of the leading manufacturers of intelligent sensors and sensor solutions for industrial applications. A unique range of products and services creates the perfect basis for controlling processes securely and efficiently, protecting individuals from accidents and preventing damage to the environment.

We have extensive experience in a wide range of industries and understand their processes and requirements. With intelligent sensors, we can deliver exactly what our customers need. In application centers in Europe, Asia and North America, system solutions are tested and optimized in accordance with customer specifications. All this makes us a reliable supplier and development partner.

Comprehensive services complete our offering: SICK LifeTime Services provide support throughout the machine life cycle and ensure safety and productivity.

For us, that is “Sensor Intelligence.”

## WORLDWIDE PRESENCE:

Contacts and other locations –[www.sick.com](http://www.sick.com)