



IME2S12-04N4DQ9

IME2S

NON-CONTACT SAFETY SWITCHES

SICK
Sensor Intelligence.



Ordering information

Type	Part no.
IME2S12-04N4DQ9	1091943

Other models and accessories → www.sick.com/IME2S



Detailed technical data

Features

Sensor principle	Inductive
Number of safe outputs	2
Housing diameter	M12
Sensing range S_n	4 mm ¹⁾
Safe switch on distance S_{ao}	3.2 mm ¹⁾
Safe switch off distance S_{ar}	6 mm ¹⁾
Active sensor surfaces	1
Actuation frequency	≤ 100 Hz
Items supplied	Including mounting nuts, brass, nickel-plated (2x)

¹⁾ Values apply for steel (FE360).

Safety-related parameters

Safety integrity level	SIL 2 (IEC 61508)
Category	Category 2 (ISO 13849-1)
Performance level	PL d (ISO 13849-1)
PFH_D (mean probability of a dangerous failure per hour)	6.0×10^{-8} ¹⁾
T_M (mission time)	20 years (ISO 13849-1)
Type	Type 3 (ISO 14119-1)
Actuator coding level	Uncoded (EN ISO 14119)
Safe state in the event of a fault	At least one safety-related semiconductor output (OSSD) is in the OFF state.

¹⁾ At 40 °C and 1000 m above sea level.

Functions

Safe series connection	With Flexi Loop (with diagnostics)
-------------------------------	------------------------------------

Interfaces

Connection type	Cable with M12 male connector, 4-pin
Length of cable	0.3 m

Cable diameter	3.9 mm
Conductor cross section	0.25 mm ²
Bend radius (with fixed installation)	> 6 x cable diameter
Bend radius (with moving cable)	> 10 x cable diameter
Cable material	PVC
Conductor material	Copper
Coupling nut material	Nickel-plated brass
IO-Link Safety	
WCDT	≤ 1 ms
OFDT	≤ 20 ms
Display elements	
LEDs	✓
Diagnostics indicator	✓
Status display	✓

Electrical data

Protection class	III (IEC 61140)
Rated insulation voltage U_i	28.8 V
Rated impulse withstand voltage U_{imp}	1,500 V
Supply voltage V_s	24 V DC (19.2 V DC ... 28.8 V DC)
Power consumption	≤ 20 mA
Type of output	Self-monitoring semiconductor outputs (OSSDs)
Response time	≤ 1 ms
Release time	≤ 1 ms
Risk time	≤ 20 ms
Switch-on time	≤ 1 s

Mechanical data

Design	Cylindrical
Housing diameter	M12
Housing length	63 mm
Thread length	36.9 mm
Material	
Housing	Nickel-plated brass
Sensor surface	VISTAL®
Cable	PVC
Installation type	Non-flush

Ambient data

Enclosure rating	IP67 (IEC 60529)
Ambient operating temperature	-25 °C ... +70 °C
Storage temperature	-25 °C ... +70 °C
Relative humidity	50 %, at 70 °C (IEC 60947-5-2)
Vibration resistance	10 Hz ... 55 Hz, 1 mm (IEC 60947-5-2)
EMC	IEC 60947-5-2, IEC 60947-5-3, IEC 61000-6-7

Classifications

ECLASS 5.0	27272401
ECLASS 5.1.4	27272401
ECLASS 6.0	27272401
ECLASS 6.2	27272401
ECLASS 7.0	27272401
ECLASS 8.0	27272401
ECLASS 8.1	27272401
ECLASS 9.0	27272401
ECLASS 10.0	27272401
ECLASS 11.0	27272401
ECLASS 12.0	27274101
ETIM 5.0	EC001818
ETIM 6.0	EC001818
ETIM 7.0	EC001818
ETIM 8.0	EC001818
UNSPSC 16.0901	39122205

Dimensional drawing (Dimensions in mm (inch))

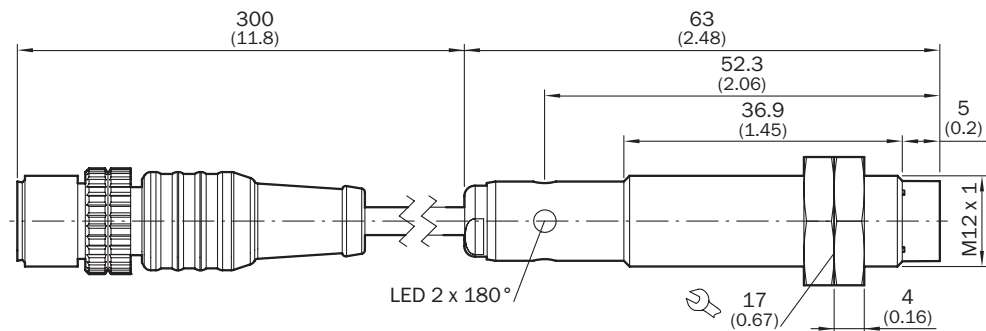

Response range

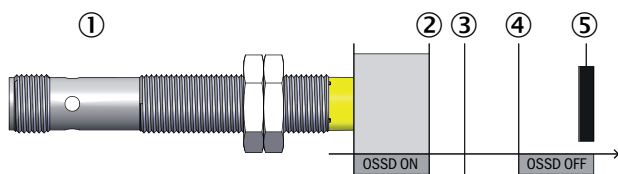

- ① Safety switch
- ② Safe switch on distance S_{ao}
- ③ Sensing range S_n
- ④ Safe switch off distance S_{ar}
- ⑤ Actuator

Pin assignment

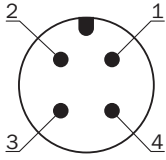







Pin	Designation	Description
1	+24 V DC	24 V DC voltage supply
2	OSSD 1	OSSD 1 output
3	0 V DC	0 V DC voltage supply
4	OSSD 2	OSSD 2 output

For details see operating instructions

Recommended accessories

Other models and accessories → www.sick.com/IME2S

	Brief description	Type	Part no.
Mounting brackets and plates			
	Mounting bracket for M12 sensors, steel, zinc coated, without mounting hardware	BEF-WN-M12	5308447
Terminal and alignment brackets			
	Clamping block for round sensors M12, without fixed stop, plastic (PA12), glass-fiber reinforced, mounting hardware included	BEF-KH-M12	2051479
Others			
	<ul style="list-style-type: none"> Connection type head A: Female connector, M12, 4-pin, straight, A-coded Connection type head B: Flying leads Signal type: Sensor/actuator cable Cable: 5 m, 4-wire, PVC Description: Sensor/actuator cable, unshielded Application: Zones with chemicals 	YF2A14-050VB3XLEAX	2096235
	<ul style="list-style-type: none"> Connection type head A: Female connector, M12, 4-pin, straight, A-coded Connection type head B: Flying leads Signal type: Sensor/actuator cable Cable: 10 m, 4-wire, PVC Description: Sensor/actuator cable, unshielded Application: Zones with chemicals 	YF2A14-100VB3XLEAX	2096236
	<ul style="list-style-type: none"> Connection type head A: Female connector, M12, 4-pin, straight, A-coded Connection type head B: Flying leads Signal type: Sensor/actuator cable Cable: 15 m, 4-wire, PVC Description: Sensor/actuator cable, unshielded Application: Zones with chemicals 	YF2A14-150VB3XLEAX	2096237

	Brief description	Type	Part no.
	<ul style="list-style-type: none">• Connection type head A: Female connector, M12, 4-pin, straight, A-coded• Connection type head B: Flying leads• Signal type: Sensor/actuator cable• Cable: 20 m, 4-wire, PVC• Description: Sensor/actuator cable, unshielded• Application: Zones with chemicals	YF2A14-200VB3XLEAX	2096238

SICK AT A GLANCE

SICK is one of the leading manufacturers of intelligent sensors and sensor solutions for industrial applications. A unique range of products and services creates the perfect basis for controlling processes securely and efficiently, protecting individuals from accidents and preventing damage to the environment.

We have extensive experience in a wide range of industries and understand their processes and requirements. With intelligent sensors, we can deliver exactly what our customers need. In application centers in Europe, Asia and North America, system solutions are tested and optimized in accordance with customer specifications. All this makes us a reliable supplier and development partner.

Comprehensive services complete our offering: SICK LifeTime Services provide support throughout the machine life cycle and ensure safety and productivity.

For us, that is “Sensor Intelligence.”

WORLDWIDE PRESENCE:

Contacts and other locations –www.sick.com