

Central Article Code: D02075C05-A

ETN Code or Other:

Created: 08/01/2009

Modified: 13/01/2009

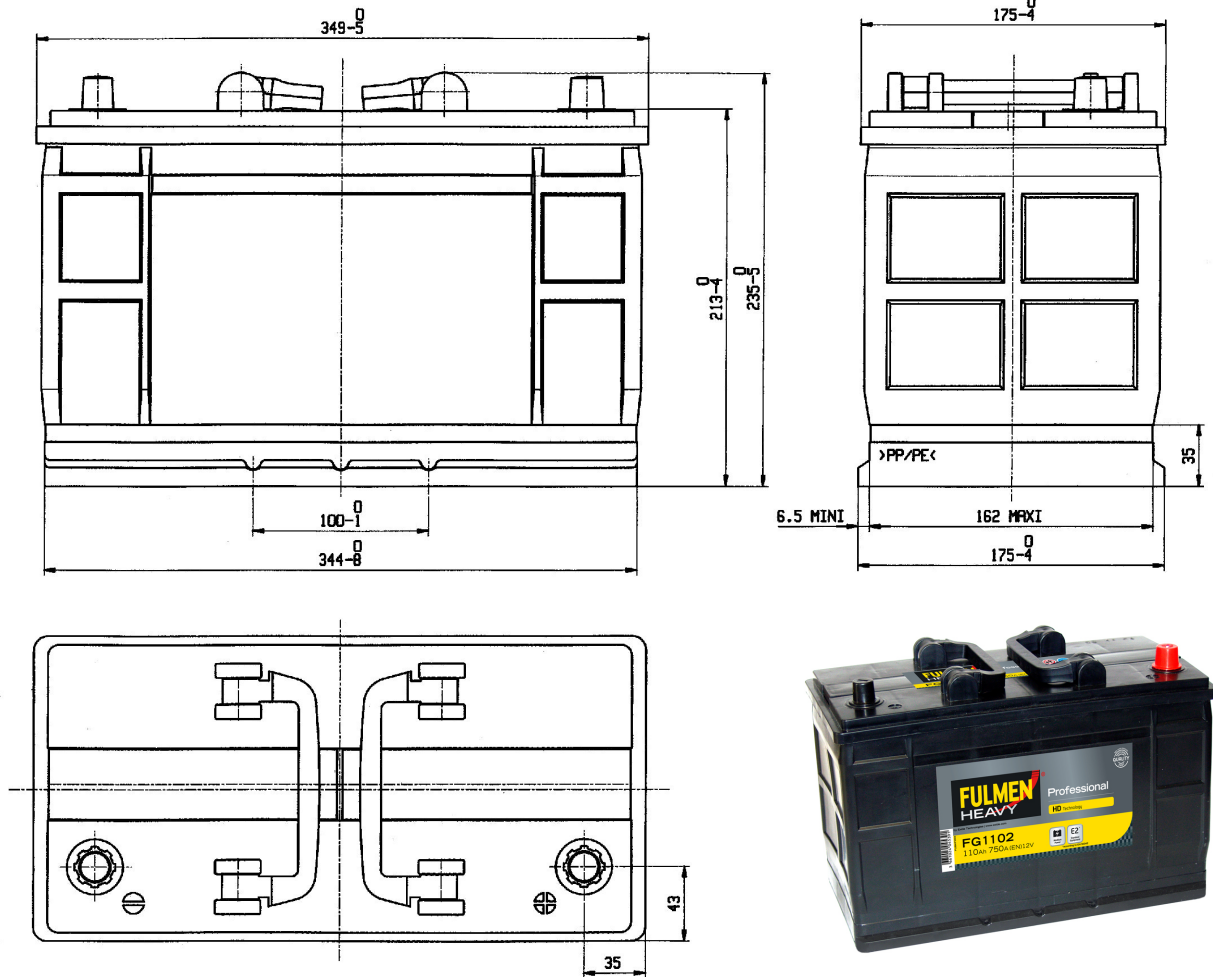

PERFORMANCES		CONTAINER	
Voltage (V):	12 V	Type:	D02 BLACK
C20 (Ah):	110.0 20 h	Hold Down:	B1
Rc (min):	0	H. D. Adapter:	No
Cranking (A):	750 EN	COVER	
Vibration:	V2 (35Hz/6g/2h)	Type:	Flat/Press BLACK
Endurance:	E2 (90 cycles@50%)	Polarity:	ETN 0
Charge:	WET	Terminals:	EN taper post
Technology:	Vented/Flooded	Terminal Adapter:	No
Grid :	Ca/Ca	SOCI:	No
WEIGHT AND STD. DIMENSIONS		Ventilation:	Independent
Battery Weight (kg):	27.48	Filter:	No
Volume acid (l):	6.54	Lateral Plug:	No
Length (mm):	349	PLUGS	
Width (mm):	175	Type:	2 x Vent BLACK
Height (mm):	235	HANDLES	
		Type:	2 x Rigid BLACK
		OTHERS	
		Degassing Tube:	No