



Product designation	Power contactor		
Product type designation	BGP09		
Contact characteristics			
Number of poles	Nr.	4	
Rated insulation voltage U_i IEC/EN	V	500	
Rated impulse withstand voltage U_{imp}	kV	6	
Operational frequency	min	Hz	25
	max	Hz	400
IEC Conventional free air thermal current I_{th}	A	20	
Operational current I_e	AC-1 ($\leq 40^\circ\text{C}$)	A	20
	AC-1 ($\leq 55^\circ\text{C}$)	A	18
	AC-1 ($\leq 70^\circ\text{C}$)	A	15
	AC-3 ($\leq 440\text{V} \leq 55^\circ\text{C}$)	A	9
	AC-4 (400V)	A	4
Rated operational power AC-1 ($T \leq 40^\circ\text{C}$)	230V	kW	8
	400V	kW	14
	500V	kW	16
Short-time allowable current for 10s (IEC/EN60947-1)	A	96	
Protection fuse	gG (IEC)	A	20
	aM (IEC)	A	10
Making capacity (RMS value)	A	92	
Breaking capacity at voltage	440V	A	72
	500V	A	72
Resistance per pole (average value)	m Ω	10	
Power dissipation per pole (average value)	I_{th}	W	4
	AC-3	W	0.81
Tightening torque for terminals	min	Nm	0.8
	max	Nm	1
	min	Ibin	9
	max	Ibin	9
Tightening torque for coil terminal	min	Nm	0.8
	max	Nm	1
	min	Ibin	9
	max	Ibin	9
Max number of wires simultaneously connectable	Nr.	2	
Conductor section	AWG/Kcmil		

			max	12
Flexible w/o lug conductor section			min	mm ² 0.8
			max	mm ² 2.5
Flexible c/w lug conductor section			min	mm ² 1.5
			max	mm ² 2.5
Flexible with insulated spade lug conductor section			min	mm ² 1.5
			max	mm ² 2.5
Power terminal protection according to IEC/EN 60529				IP00
Mechanical features				
Operating position			normal allowable	Vertical plan ±30°
Fixing				Screw / DIN rail 35mm
Weight				g 242
Conductor section				
	AWG/kcmil conductor section		max	12
Auxiliary contact characteristics				
Thermal current I _{th}			A	10
IEC/EN 60947-5-1 designation				Q600
Operations				
Mechanical life			cycles	20000000
Electrical life			cycles	500000
Safety related data				
Performance level B10d according to EN/ISO 13489-1			rated load mechanical load	cycles 500000 cycles 20000000
Mirror contacts according to IEC/EN 60947-4-1				yes
EMC compatibility				yes
DC coil operating				
DC rated control voltage			V	12
DC operating voltage				
	pick-up		min	%Us 75
			max	%Us 115
	drop-out		min	%Us 10
			max	%Us 25
Average coil consumption ≤20°C			in-rush holding	W 3.2 W 3.2
Max cycles frequency				
Mechanical operation			cycles/h	3600
Operating times				
Average time for U _s control				
	in AC	Closing NO	min	ms 12
			max	ms 21

Opening NO	min	ms	9
	max	ms	18
Closing NC	min	ms	17
	max	ms	26
Opening NC	min	ms	7
	max	ms	17
<hr/>			
in DC			
Closing NO	min	ms	18
	max	ms	25
Opening NO	min	ms	2
	max	ms	3
Closing NC	min	ms	3
	max	ms	5
Opening NC	min	ms	11
	max	ms	17

UL technical data

Full-load current (FLA) for three-phase AC motor

at 480V	A	7.6
at 600V	A	6.1

Yielded mechanical performance

for single-phase AC motor

110/120V	HP	0.5
230V	HP	1.5

for three-phase AC motor

200/208V	HP	2
220/230V	HP	3
460/480V	HP	5
575/600V	HP	5

General USE

Contactor

AC current	A	20
------------	---	----

Ambient conditions

Temperature

Operating temperature

min	°C	-50
max	°C	+70

Storage temperature

min	°C	-60
max	°C	+80

Max altitude

m	3000
---	------

Resistance & Protection

Pollution degree

3

Dimensions

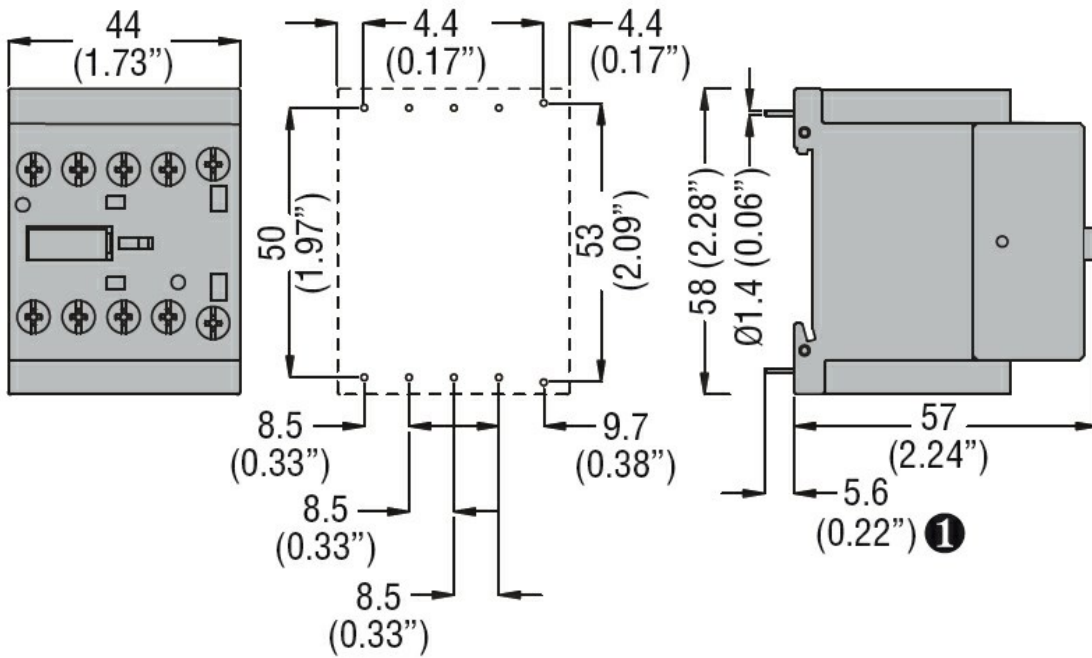

① Recommended PCB drillings 1.7-2mm.

Wiring diagrams

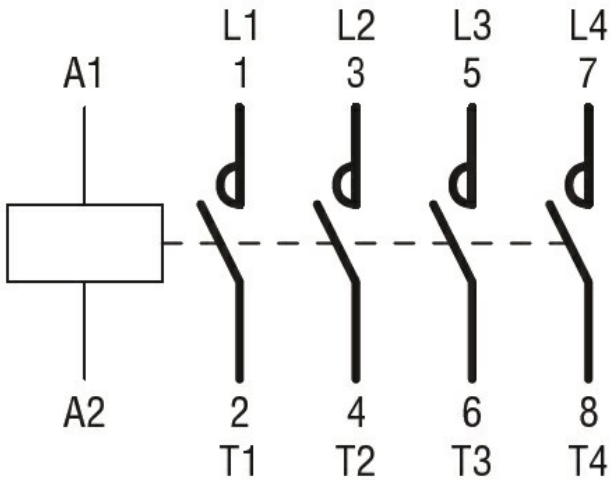

Certifications and compliance

Compliance

- CSA C22.2 n° 60947-1
- CSA C22.2 n° 60947-4-1
- IEC/EN 60947-1
- IEC/EN 60947-4-1
- UL 60947-1
- UL 60947-4-1

Certificates

- cURus
- EAC

ETIM classification

ETIM 8.0

EC000066 -
Power contactor,
AC switching