

## 10 Nm Right-angle gearbox with 33 W motor 33 W Part number 80831018



- Output perpendicular to motor
- Ideal for short reduction ratios
- Silent-running gearbox
- Non-reversible movement at high ratios
- UL approved

### Part numbers

	Type	Type	Voltages	Speed (rpm)	Available torque (Nm)	Ratios
<b>80831018</b>	33 W	808310	48 V	30	2,9	50

### Specifications

#### General characteristics

Motor	828300
Gearbox	810410
Maximum permitted torque (Nm)	10
Axial load dynamic (daN)	10
Radial load dynamic (daN)	15
Operating temperature range (°C)	-10 → +40
Service life (h)	5000
Weight (g)	2110
Approvals	UL 1004

### Dimensions (mm)

808310

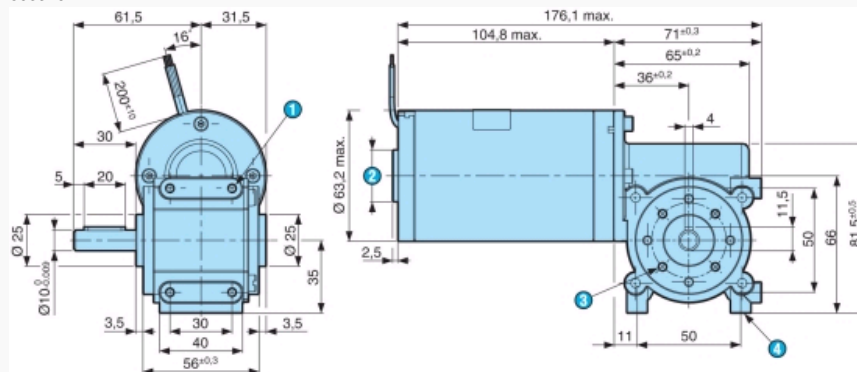

N°	Legend
①	4 x M5 depth 8 mm
②	Centring diameter
③	4 x M4 over Ø 36 - depth 8 mm
	4 x M5 - depth 8 mm

### Product adaptations



- Encoder with 1, 5, 12 pulses/revolution - 1 or 2 channels, or 48 pulses/revolution - 1 channel
- 2-channel encoder, 200, 500 or 1000 pulses/revolution
- Left-hand, right-hand, double, special shaft
- Special connectors
- Special reduction ratio
- UL/CSA logo on label
- With 828305 - 67 W motor