



C4C-EX19510A10000

deTec

SAFETY LIGHT CURTAINS

SICK
Sensor Intelligence.



Ordering information

deTec4 Core Ex II 3GD

| Resolution | Scanning range | Protective field height | System part | Type | Part no. |
|------------|----------------|-------------------------|-------------|-------------------|----------|
| 14 mm | 10 m | 1,950 mm | Receiver | C4C-EX19510A10000 | 1220337 |

Other models and accessories → www.sick.com/deTec

Illustration may differ



Detailed technical data

Features

| | |
|--------------------------------|---|
| Sub product family | deTec4 Core Ex II 3GD |
| Application | Explosive areas |
| Ex-approvals | ATEX for gas: II 3G Ex ec op is IIC T4 Gc ATEX for dust: II 3D Ex tc IIIC T135°C Dc |
| System part | Receiver |
| Compatible sender | 1220324 |
| Resolution | 14 mm |
| Scanning range | 10 m |
| Protective field height | 1,950 mm |
| Response time | 21 ms |
| No blind zones | Yes |
| Synchronization | Optical synchronisation |
| Items supplied | Receiver Test rod with diameter corresponding to the resolution of the safety light curtain “Notes for explosion protection” label(s) Safety instruction Mounting instructions Operating instructions for download |

Safety-related parameters

| | |
|---|--------------------------|
| Type | Type 4 (IEC 61496-1) |
| Safety integrity level | SIL 3 (IEC 61508) |
| Category | Category 4 (ISO 13849-1) |
| Performance level | PL e (ISO 13849-1) |
| PFH_D (mean probability of a dangerous failure per hour) | 3.7×10^{-9} |

| | |
|---|--|
| T_M (mission time) | 20 years (ISO 13849-1) |
| Safe state in the event of a fault | At least one OSSD is in the OFF state. |

Functions

| | |
|--|---|
| Protective operation | ✓ |
| Automatic calibration of the protective field width | ✓ |

Interfaces

| | |
|--------------------------|---------------------------|
| System connection | Male connector M12, 5-pin |
| Length of cable | 150 mm |
| Cable diameter | 4.3 mm |
| Cable bend radius | |
| Stationary position | > 12 x cable diameter |
| Flexible use | > 15 x cable diameter |
| Display elements | LEDs |

Electrical data

| | |
|--|--|
| Protection class | III (IEC 61140) |
| Supply voltage V_S | 24 V DC (19.2 V ... 28.8 V) |
| Ripple | ≤ 10 % |
| Power consumption typical | 4.56 W (DC) |
| Output signal switching devices (OSSDs) | |
| Type of output | 2 PNP semiconductors, short-circuit protected, cross-circuit monitored ¹⁾ |
| ON state, switching voltage HIGH | 24 V DC (V _S - 2.25 V DC ... V _S) |
| OFF state, switching voltage LOW | ≤ 2 V DC |
| Current-carrying capacity per OSSD | ≤ 300 mA |

¹⁾ Applies to the voltage range between -30 V and +30 V.

Mechanical data

| | |
|-------------------------|---------------------------|
| Dimensions | See dimensional drawing |
| Housing material | Aluminum extruded profile |

Ambient data

| | |
|--------------------------------------|--------------------------------------|
| Enclosure rating | IP65 (IEC 60529) IP67 (IEC 60529) |
| Ambient operating temperature | 0 °C ... +55 °C |
| Storage temperature | -30 °C ... +70 °C |
| Air humidity | 15 % ... 95 %, Non-condensing |
| Vibration resistance | 5 g, 10 Hz ... 55 Hz (IEC 60068-2-6) |
| Shock resistance | 10 g, 16 ms (IEC 60068-2-27) |

Classifications

| | |
|---------------------|----------|
| ECLASS 5.0 | 27272704 |
| ECLASS 5.1.4 | 27272704 |
| ECLASS 6.0 | 27272704 |
| ECLASS 6.2 | 27272704 |

| | |
|-----------------------|----------|
| ECLASS 7.0 | 27272704 |
| ECLASS 8.0 | 27272704 |
| ECLASS 8.1 | 27272704 |
| ECLASS 9.0 | 27272704 |
| ECLASS 10.0 | 27272704 |
| ECLASS 11.0 | 27272704 |
| ECLASS 12.0 | 27272704 |
| ETIM 5.0 | EC002549 |
| ETIM 6.0 | EC002549 |
| ETIM 7.0 | EC002549 |
| ETIM 8.0 | EC002549 |
| UNSPSC 16.0901 | 46171620 |

Dimensional drawing (Dimensions in mm (inch))

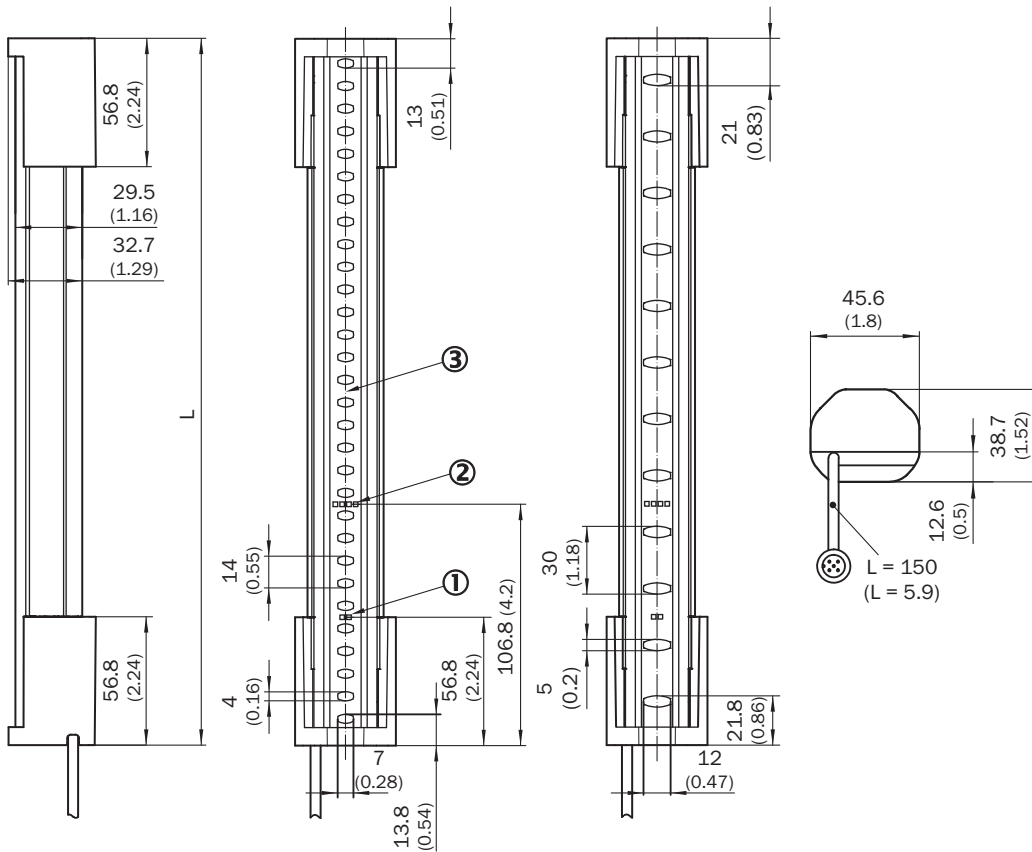







- ① Operating indicator
- ② Alignment indicator
- ③ Optical axis







| L | |
|----------|-----|
| 300 | 313 |
| 450 | 463 |
| 600 | 613 |

| | L |
|-------|-------|
| 750 | 763 |
| 900 | 913 |
| 1,050 | 1,063 |
| 1,200 | 1,213 |
| 1,350 | 1,362 |
| 1,500 | 1,512 |
| 1,650 | 1,662 |
| 1,800 | 1,812 |
| 1,950 | 1,962 |
| 2,100 | 2,112 |

Recommended accessories

Other models and accessories → www.sick.com/deTec

| | Brief description | Type | Part no. |
|---|---|--------------------|----------|
| Test and monitoring tools | | | |
|  | 14 mm diameter, 250 mm length | Test rod 14 mm | 2022599 |
| Distributors | | | |
|  | <ul style="list-style-type: none"> • Connection type head A: Female connector, M12, 5-pin, A-coded • Connection type head B: Male connector, M12, 5-pin, A-coded • Connection type head C: Female connector, M12, 5-pin, A-coded • Description: T-piece for simultaneous connection to sender and receiver, splits the cable from the control cabinet to the sender and receiver • Note: 5-pin | DSC-1205T000025KM0 | 6030664 |
| Terminal and alignment brackets | | | |
|  | 4 pieces, FlexFix bracket for 2 devices (e.g. sender and receiver), can be aligned $\pm 15^\circ$, including M5 screw, plastic | BEF-1SHABPKU4 | 2066614 |
|  | 4 pieces, QuickFix bracket for 2 devices (e.g. sender and receiver), plastic | BEF-3SHABPKU4 | 2098710 |
| Others | | | |
|  | <ul style="list-style-type: none"> • Connection type head A: Female connector, M12, 5-pin, straight, A-coded • Connection type head B: Male connector, M12, 5-pin, straight, A-coded • Signal type: Sensor/actuator cable • Cable: 2 m, 5-wire, PUR, halogen-free • Description: Sensor/actuator cable, unshielded • Application: Zones with oils and lubricants, Drag chain operation, Robot | YF2A15-020UB5M2A15 | 2096009 |
|  | <ul style="list-style-type: none"> • Connection type head A: Female connector, M12, 5-pin, straight, A-coded • Connection type head B: Flying leads • Signal type: Sensor/actuator cable • Cable: 2 m, 5-wire, PUR, halogen-free • Description: Sensor/actuator cable, unshielded • Application: Zones with oils and lubricants, Drag chain operation, Robot | YF2A15-020UB5XLEAX | 2095617 |

| | Brief description | Type | Part no. |
|---|---|--------------------|----------|
|  | <ul style="list-style-type: none"> • Connection type head A: Female connector, M12, 5-pin, straight, A-coded • Connection type head B: Male connector, M12, 5-pin, straight, A-coded • Signal type: Sensor/actuator cable • Cable: 5 m, 5-wire, PUR, halogen-free • Description: Sensor/actuator cable, unshielded • Application: Zones with oils and lubricants, Drag chain operation, Robot | YF2A15-050UB5M2A15 | 2096010 |
|  | <ul style="list-style-type: none"> • Connection type head A: Female connector, M12, 5-pin, straight, A-coded • Connection type head B: Flying leads • Signal type: Sensor/actuator cable • Cable: 5 m, 5-wire, PUR, halogen-free • Description: Sensor/actuator cable, unshielded • Application: Zones with oils and lubricants, Drag chain operation, Robot | YF2A15-050UB5XLEAX | 2095618 |
|  | <ul style="list-style-type: none"> • Connection type head A: Female connector, M12, 5-pin, straight, A-coded • Connection type head B: Male connector, M12, 5-pin, straight, A-coded • Signal type: Sensor/actuator cable • Cable: 10 m, 5-wire, PUR, halogen-free • Description: Sensor/actuator cable, unshielded • Application: Zones with oils and lubricants, Drag chain operation, Robot | YF2A15-100UB5M2A15 | 2096011 |
|  | <ul style="list-style-type: none"> • Connection type head A: Female connector, M12, 5-pin, straight, A-coded • Connection type head B: Flying leads • Signal type: Sensor/actuator cable • Cable: 10 m, 5-wire, PUR, halogen-free • Description: Sensor/actuator cable, unshielded • Application: Zones with oils and lubricants, Drag chain operation, Robot | YF2A15-100UB5XLEAX | 2095619 |
| Safety switching amplifier | | | |
|  | <ul style="list-style-type: none"> • Applications: Evaluation unit • Compatible sensor types: Safety sensors with OSSDs • Connection type: Front connector with spring terminals • Restart interlock: yes • External device monitoring (EDM): Integrated • Outputs: 2 enabling current paths (safe), 2 application diagnostic outputs (not safe), 1 test pulse output (not safe) • Housing width: 18 mm | RLY3-OSSD200 | 1085344 |
|  | <ul style="list-style-type: none"> • Applications: Evaluation unit • Compatible sensor types: Safety sensors with OSSDs • Connection type: Front connector with spring terminals • Restart interlock: yes • External device monitoring (EDM): Integrated • Outputs: 3 enabling current paths (safe), 2 application diagnostic outputs (not safe), 1 test pulse output (not safe) • Housing width: 18 mm | RLY3-OSSD300 | 1099969 |

SICK AT A GLANCE

SICK is one of the leading manufacturers of intelligent sensors and sensor solutions for industrial applications. A unique range of products and services creates the perfect basis for controlling processes securely and efficiently, protecting individuals from accidents and preventing damage to the environment.

We have extensive experience in a wide range of industries and understand their processes and requirements. With intelligent sensors, we can deliver exactly what our customers need. In application centers in Europe, Asia and North America, system solutions are tested and optimized in accordance with customer specifications. All this makes us a reliable supplier and development partner.

Comprehensive services complete our offering: SICK LifeTime Services provide support throughout the machine life cycle and ensure safety and productivity.

For us, that is “Sensor Intelligence.”

WORLDWIDE PRESENCE:

Contacts and other locations –www.sick.com