

















	<b>WINK 2 30W CCT</b>			<b>Code / Réf</b>
				<b>51316</b>

220-240V~ 50/60Hz	IP65	IK08	CXs 0.024m <sup>2</sup>	kg 0.51											
----------------------	------	------	----------------------------	------------	---	---	---	---	---	--	---	---	---	---	---

FR	 Ne jetez pas vos déchets électriques avec les déchets ménagers. Confiez votre appareil à votre centre de recyclage pour son traitement approprié.	 Suivez la fiche d'instructions pour garantir un fonctionnement fiable et sécurisé. À conserver pour consultation ultérieure. Les produits doivent être installés par un électricien qualifié conformément aux normes internationales de câblage.
EN	Waste electrical products must not be disposed of with household waste. This tool should be taken to your recycling center for safe treatment.	Follow Instruction Sheet to ensure safe and reliable operation. Retain for future reference. Products should be installed by a qualified Electrician in accordance with International Wiring Regulations.
DE	Dieses Gerät darf nicht mit dem Hausmüll/Restmüll entsorgt werden. Das Altgerät nur in einer öffentlichen Sammelstelle abgeben.	Die Gebrauchsanweisung befolgen, damit der sichere und zuverlässige Betrieb gewährleistet ist. Zum späteren Nachschlagen aufheben. Die Produkte müssen von einem qualifizierten Elektriker in Übereinstimmung mit den relevanten Vorschriften installiert werden.
IT	I rifiuti elettrici non devono essere smaltiti con i rifiuti domestici. Questo strumento deve essere portato al centro di riciclaggio per un trattamento sicuro.	Seguire il foglio delle istruzioni per garantire il funzionamento sicuro e affidabile. Conservare per riferimento futuro. I prodotti devono essere installati da un elettricista qualificato conformemente alle normative internazionali sui cablaggi.
ES	Los productos eléctricos de desecho no deben ser eliminados con residuos domésticos. Esta herramienta debe ser llevada a su centro de reciclaje para un tratamiento seguro.	Siga la hoja de instrucciones para garantizar la seguridad y un funcionamiento fiable. Consérvela para utilizarla como material de referencia en el futuro. Los productos los debe instalar un técnico electricista cualificado en virtud de las normativas internacionales en materia de cableado.
FR	La source lumineuse (LED) contenue dans ce luminaire n'est pas remplaçable, lorsque la source lumineuse atteint sa fin de vie le luminaire entier doit être remplacé.	
EN	The light source (LED) contained in this luminaire is not replaceable, when the light source reaches its end of life the entire luminaire must be replaced.	
DE	Die in dieser Leuchte enthaltene Lichtquelle (LED) ist nicht auswechselbar, wenn die Lichtquelle ihre Lebensdauer erreicht, muss die gesamte Leuchte ersetzt werden..	
IT	La sorgente luminosa (LED) contenuta in questo apparecchio non è sostituibile, quando la sorgente luminosa raggiunge la fine della sua vita l'intero apparecchio deve essere sostituito.	
ES	La fuente luminosa (LED) contenida en esta luminaria no es sustituible, cuando la fuente luminosa llega a su fin de vida útil debe sustituirse toda la luminaria.	
FR	  	

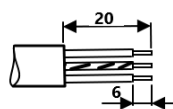
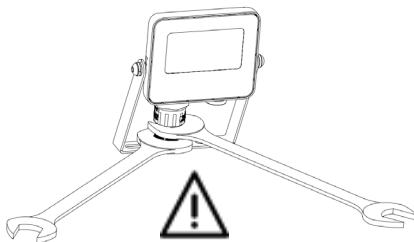
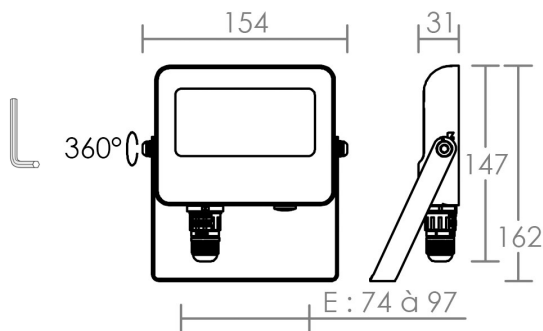
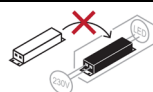
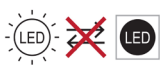

0.5 -2.5 mm<sup>2</sup>  
D : 7- 8 mm

N + L + 