

# DUV60E-32KFAABA

DUV60

MEASURING WHEEL ENCODERS

**SICK**  
Sensor Intelligence.



Illustration may differ



### Ordering information

| Type            | Part no. |
|-----------------|----------|
| DUV60E-32KFAABA | 1101804  |

Other models and accessories → [www.sick.com/DUV60](http://www.sick.com/DUV60)

### Detailed technical data

#### Performance

|                                 |   |
|---------------------------------|---|
| <b>Pulses per revolution</b>    | 1 ... 2048 <sup>1)</sup>                          |
| <b>Resolution in pulses/mm</b>  | 0.125 mm/pulse to 304.8 mm/pulse (type-dependent) |
| <b>Measuring step</b>           | 90° electric/pulses per revolution                |
| <b>Measuring step deviation</b> | ± 18°, / pulses per revolution                    |
| <b>Error limits</b>             | Measuring step deviation x 3                      |
| <b>Duty cycle</b>               | 0.5 ± 5 %   |
| <b>Initialization time</b>      | < 5 ms <sup>2)</sup>                              |

<sup>1)</sup> Available pulses per revolution see type code.

<sup>2)</sup> Valid positional data can be read once this time has elapsed.

#### Interfaces

|                                       |                               |
|---------------------------------------|-------------------------------|
| <b>Communication interface</b>        | Incremental                   |
| <b>Communication Interface detail</b> | TTL / HTL                     |
| <b>Parameterising data</b>            | DIP switch, selectable output |

#### Electrical data

|  |   |
|--|---|
| <b>Operating power consumption (no load)</b> | 120 mA  |
| <b>Connection type</b>                       | Male connector, M12, 4-pin, universal <sup>1)</sup> |
| <b>Pulses per revolution</b>                 | ✓   |
| <b>Output voltage</b>                        | ✓   |
| <b>Direction of rotation</b>                 | ✓   |
| <b>Power consumption max. without load</b>   | ≤ 1.25 W  |
| <b>Supply voltage</b>                        | 4.75 V ... 30 V                                     |
| <b>Load current max.</b>                     | ≤ 30 mA, per channel                                |
| <b>Maximum output frequency</b>              | 60 kHz  |
| <b>Reference signal, number</b>              | 1   |

<sup>1)</sup> The universal connection is rotatable so that it is possible to position the connector in the radial or axial direction.

<sup>2)</sup> This product is a standard product and does not constitute a safety component as defined in the Machinery Directive. Calculation based on nominal load of components, average ambient temperature 40°C, frequency of use 8760 h/a. All electronic failures are considered hazardous. For more information, see document no. 8015532.

|  |  |
|--|--|
| <b>Reference signal, position</b>              | 180°, electric, gated with A             |
| <b>Reverse polarity protection</b>             | ✓  |
| <b>Short-circuit protection of the outputs</b> | ✓  |
| <b>MTTFd: mean time to dangerous failure</b>   | 275 years (EN ISO 13849-1) <sup>2)</sup> |

<sup>1)</sup> The universal connection is rotatable so that it is possible to position the connector in the radial or axial direction.

<sup>2)</sup> This product is a standard product and does not constitute a safety component as defined in the Machinery Directive. Calculation based on nominal load of components, average ambient temperature 40 °C, frequency of use 8760 h/a. All electronic failures are considered hazardous. For more information, see document no. 8015532.

## Mechanical data

|  |                                      |
|--|--------------------------------------|
| <b>Measuring wheel circumference</b>                                       | 300 mm                               |
| <b>Measuring wheel surface</b>   | O-ring NBR70 <sup>1)</sup>           |
| <b>Spring arm design</b>   | Spring arm, encoder on mounting side |
| <b>Mass</b>  | 0.45 kg <sup>2)</sup>                |
| <b>Encoder material</b>  |                                      |
| Shaft  | Stainless steel                      |
| Flange   | Aluminum                             |
| Housing  | Aluminum                             |
| Cable  | PVC                                  |
| <b>Spring arm mechanism material</b>                                       |                                      |
| Spring element   | Spring steel                         |
| Measuring wheel, spring arm  | Aluminum                             |
| <b>Start up torque</b>   | 1.2 Ncm                              |
| <b>Operating torque</b>  | 1.1 Ncm                              |
| <b>Operating speed</b>   | 1,500 min <sup>-1</sup>              |
| <b>Bearing lifetime</b>  | 3.6 x 10 <sup>9</sup> revolutions    |
| <b>Maximum travel/deflection of spring arm</b>                             | 14 mm <sup>3)</sup>                  |
| <b>Recommended pretension</b>  | 10 mm <sup>3)</sup>                  |
| <b>Max. permissible working area for the spring (continuous operation)</b> | ± 3 mm                               |
| <b>Service life of spring element</b>                                      | > 1.4 million cycles <sup>3)</sup>   |

<sup>1)</sup> The surface of a measuring wheel is subject to wear. This depends on contact pressure, acceleration behavior in the application, traversing speed, measurement surface, mechanical alignment of the measuring wheel, temperature, and ambient conditions. We recommend you regularly check the condition of the measuring wheel and replace as required.

<sup>2)</sup> Based on encoder with male connector.

<sup>3)</sup> Only applies to variants with spring arm mounting.

## Ambient data

|                                      |  |
|--------------------------------------|--|
| <b>EMC</b>                           | According to EN 61000-6-2 and EN 61000-6-3 |
| <b>Enclosure rating</b>              | IP65 <sup>1)</sup>                         |
| <b>Permissible relative humidity</b> | 90 % (Condensation not permitted)          |
| <b>Operating temperature range</b>   | -30 °C ... +70 °C                          |
| <b>Storage temperature range</b>     | -40 °C ... +75 °C                          |

<sup>1)</sup> When the mating connector is installed and the DIP switch door is sealed with the encoder housing.

### Classifications

|                       |          |
|-----------------------|----------|
| <b>eCl@ss 5.0</b>     | 27270501 |
| <b>eCl@ss 5.1.4</b>   | 27270501 |
| <b>eCl@ss 6.0</b>     | 27270590 |
| <b>eCl@ss 6.2</b>     | 27270590 |
| <b>eCl@ss 7.0</b>     | 27270501 |
| <b>eCl@ss 8.0</b>     | 27270501 |
| <b>eCl@ss 8.1</b>     | 27270501 |
| <b>eCl@ss 9.0</b>     | 27270501 |
| <b>eCl@ss 10.0</b>    | 27270790 |
| <b>eCl@ss 11.0</b>    | 27270707 |
| <b>eCl@ss 12.0</b>    | 27270504 |
| <b>ETIM 5.0</b>       | EC001486 |
| <b>ETIM 6.0</b>       | EC001486 |
| <b>ETIM 7.0</b>       | EC001486 |
| <b>ETIM 8.0</b>       | EC001486 |
| <b>UNSPSC 16.0901</b> | 41112113 |

### Dimensional drawing (Dimensions in mm (inch))

One measuring wheel, 63.5 mm spring arm, encoder on mounting side, male connector

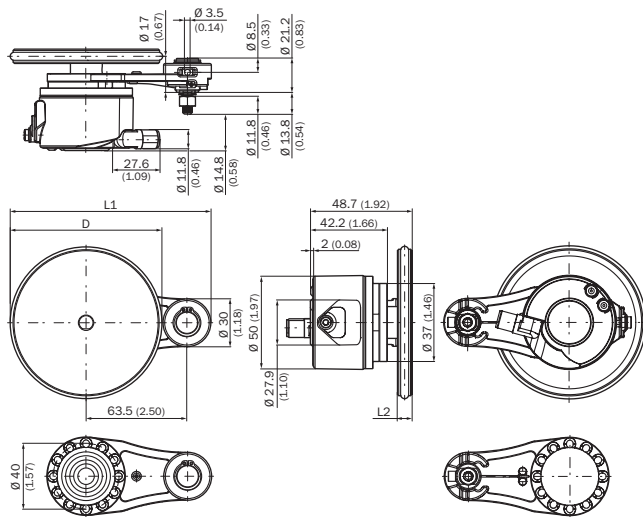

PIN assignment



| Wire colors (cable connection) | Male connector M12, 4-pin | Male connector M12, 8-pin | Output function |                |                |   | Explanation            |
|--------------------------------|---------------------------|---------------------------|-----------------|----------------|----------------|---|------------------------|
|                                |                           |                           | A               | B              | C              | D   |                        |
| Brown                          | -                         | 1                         | A-              | CW-            | A-             | A-  | Signal                 |
| White                          | 4                         | 2                         | A               | CW             | A              | A   | Signal                 |
| Black                          | -                         | 3                         | B-              | CCW-           | Direction-     | B-  | Signal                 |
| Pink                           | 2                         | 4                         | B               | CCW            | Direction      | Fault (M12, 4-pin)<br>B (M12, 8-pin and cable connection) | Signal                 |
| Yellow                         | -                         | 5                         | Z-              | Fault-         | Fault-         | Fault-  | Signal                 |
| Violet                         | -                         | 6                         | Z               | Fault          | Fault          | Fault   | Signal                 |
| Blue                           | 3                         | 7                         | GND             | GND            | GND            | GND   | Ground connection      |
| Red                            | 1                         | 8                         | U <sub>S</sub>  | U <sub>S</sub> | U <sub>S</sub> | U <sub>S</sub>  | Supply voltage         |
| -                              | -                         | -                         | Case            | Case           | Case           | Case  | Earth fault protection |
| Shielding                      | -                         | -                         | Shielding       | Shielding      | Shielding      | Shielding   | Shielding              |

Diagrams

Single wheel, 63.5 mm spring arm

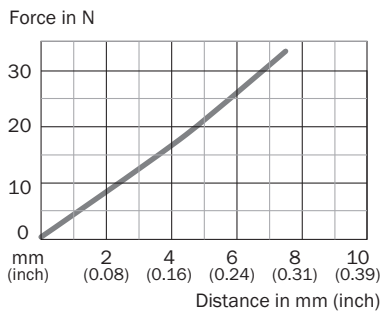

- ① Recommended pre-tension (10 mm)
- ② Permissible working area (±3 mm)
- ③ Recommended spring deflection (2 - 13 mm)
- ④ Maximum spring deflection (14 mm)

### Adjustments







Status indicator LED

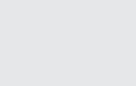

- ① Signal
- ② Fault/Power

### Recommended accessories

Other models and accessories → [www.sick.com/DUV60](http://www.sick.com/DUV60)

|   | Brief description  | Type            | Part no. |
|---|--|-----------------|----------|
| <b>Mounting brackets and plates</b>   |  |                 |          |
|  | Mounting bracket for encoder with spigot 36 mm   | BEF-WF-MRS      | 2084709  |
| <b>Plug connectors and cables</b>   |  |                 |          |
|  | Head A: Flying leads<br>Head B: Flying leads<br>Cable: CANopen, DeviceNet™, shielded<br>Wire shield Al-Pt film, overall shield C-screen tin-plated | LTG-2804-MW     | 6028328  |
|  | Head A: female connector, M12, 4-pin, straight, A-coded<br>Head B: Flying leads<br>Cable: PUR, halogen-free, shielded, 2 m                         | DOL-1204-G02MAC | 2088079  |
|  | Head A: female connector, M12, 4-pin, straight<br>Head B: Flying leads<br>Cable: PUR, halogen-free, shielded, 5 m                                  | DOL-1204-G05MAC | 6038621  |
|  | Head A: female connector, M12, 4-pin, straight<br>Head B: Flying leads<br>Cable: Welding spark resistant, PUR, halogen-free, shielded, 10 m        | DOL-1204-G10MAC | 6041797  |
|  | Head A: female connector, M12, 4-pin, straight, A-coded<br>Head B: Flying leads<br>Cable: Sensor/actuator cable, PUR, halogen-free, shielded, 20 m | DOL-1204-G20MAC | 2088080  |
|  | Head A: female connector, M12, 5-pin, straight<br>Cable: CANopen, DeviceNet™, shielded   | DOS-1205-GA     | 6027534  |

## SICK AT A GLANCE

SICK is one of the leading manufacturers of intelligent sensors and sensor solutions for industrial applications. A unique range of products and services creates the perfect basis for controlling processes securely and efficiently, protecting individuals from accidents and preventing damage to the environment.

We have extensive experience in a wide range of industries and understand their processes and requirements. With intelligent sensors, we can deliver exactly what our customers need. In application centers in Europe, Asia and North America, system solutions are tested and optimized in accordance with customer specifications. All this makes us a reliable supplier and development partner.

Comprehensive services complete our offering: SICK LifeTime Services provide support throughout the machine life cycle and ensure safety and productivity.

For us, that is “Sensor Intelligence.”

## WORLDWIDE PRESENCE:

Contacts and other locations –[www.sick.com](http://www.sick.com)