

Part number

PE 1665 SA



Mobile plug, PLUSO series, 3 poles + N + PE, 6 h (red), 16 A, 380 ÷ 415 V, angled

Product description		Material properties	
Product type	Plug Mobile	Colour	RAL 7035 grey, RAL 3000 red
Series	PE...SA, PLUSO	RoHs conformity	Compliant with exemption 6(c): copper alloy containing up to 4% lead by weight
Connection type	Screw terminal connection	China RoHs - EFUP	50
N. of poles	3 poles + N + 	REACH SVHC substances	Yes Lead
Clock position	6	SCIP number	Ca7de37f-add8-4b77-9861-279c94903ade
Specification	Angled	Approvals / Standards	
Technical data		Reference standard	EN 60309-1 and -2
Current	16 A	General ordering information	
Voltage	380 ÷ 415 V	EAN13 code	8015747064835
IP degree of protection	IP44	Packaging Information	
Further technical details		Packaging length	210,00 mm
Weight	148,00 g	Packaging height	135,00 mm
Operating temperature range (min, max)	-25°C ... +40°C	Packaging width	280,00 mm
		Packaging weight	1,69 kg
		Packaging volume	7,94 dm ³
		Packaging description	Carton box
		Packaging quantity	10 Pcs
		Packaging EAN code	8015747219792

Part number

PE 1665 SA



Catalogue drawings

(16 / 32A) PE ... SA

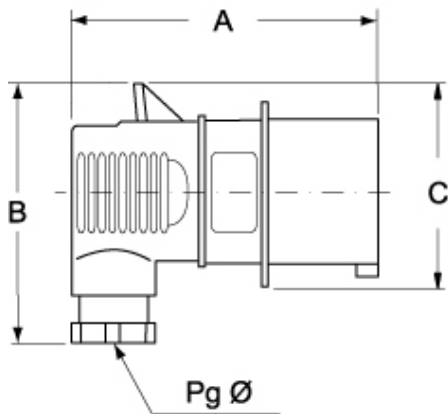

PE...SA	A	B	C	Pg Ø
16A 2P+⊕	100	77	59	13,5
3P+⊕	100	84	68	16
3P+N+⊕	106	91	77	16
32A 2P+⊕	131	100	82	21
3P+⊕	131	100	82	21
3P+N+⊕	131	107	93	21

Notes

Dimensions shown in mm are not binding and may be changed without notice.

plug pins), add "N" to the pre-code of the corresponding standard product code; for example: PE becomes PEN and PEW becomes PEWN.

- IP44 and IP67 degrees of protection (EN 60529)

- Compliant with EN 60309-1 and -2
- Enclosure, insert and locking ring in insulating, thermoplastic, self-extinguishing material
- Cable anchoring collar incorporated in the insert
- Entry with cable gland
- PE...SA types (IP44), enclosure colour coded according to the operating voltage
- PEW...SA types (IP67), RAL 7035 grey enclosure, locking ring with gasket colour coded according to the operating voltage
- Terminals with retained screws
- Nickel-plated contacts, available on request for 16A and 32A. For the code of products with nickel-plated contacts (socket holes,