



Product designation	LATCHING RELAY		
Product type designation	CNB		
Operating voltage type	AC		
Manual control	YES		
Number of poles	2		
Number of DIN modules	1		
Electrical features			
IEC Conventional free air thermal current I _{th}	A	20	
Rated insulation voltage U _i IEC/EN	V	440	
Rated impulse withstand voltage U _{imp}	kV	4	
Minimum switching capacity	≥10V ≥100mA		
Power dissipation per pole (average value) I _{th}	W	1.7	
Control circuit			
Auxiliary rated supply voltage U _s	230VAC		
Auxiliary contacts	NO	Nr.	2
Average coil consumption ≤20°C	in-rush	W	18/13
Operating voltage			
pick-up	min	%U _s	85
	max	%U _s	110
Operating times			
Average time			
Closing NO	min	ms	5
	max	ms	20
Opening NO	min	ms	5
	max	ms	20
Operations			
Mechanical life		cycles	3000000
Electrical life AC-3		cycles	300000
Electrical life AC1		cycles	200000
Ambient conditions			
Operating temperature	min	°C	-5
	max	°C	55
Storage temperature	min	°C	-30
	max	°C	80
Max altitude		m	2000
Mechanical features			
Fixing	DIN rail 35mm		

Tightening torque for coil terminal

max	Nm	0.6
max	lbin	0.6

Tightening torque for terminals

max	Nm	1.2
max	lbin	0.9

Conductor section

Coil terminal

min	mm ²	1
max	mm ²	2.5

Power terminal

min	mm ²	1
max	mm ²	10

Terminals tool

PZ2

Weight

g 135

Resistance & Protection

Frontal IP degree

IP20

Pollution degree

3

Dimensions

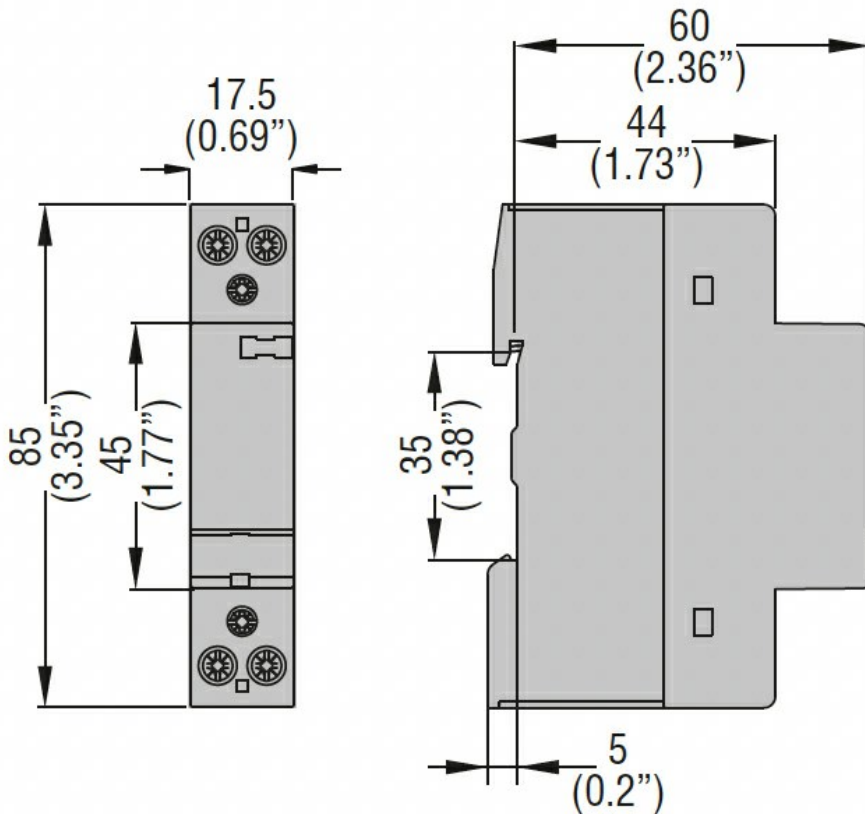

Wiring diagrams

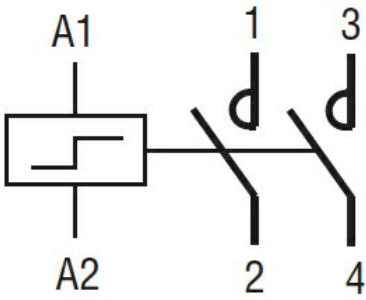

Certifications and compliance

Compliance

IEC/EN/BS 60669-1
IEC/EN/BS 60669-2-2
IEC/EN/BS 60947-1
IEC/EN/BS 60947-4-1
IEC/EN/BS 60947-5-1
IEC/EN/BS 61095

Certificates

EAC

ETIM classification

ETIM 8.0

EC000066 -
Power contactor,
AC switching