



WSE9C-3P2430A70

W9

SMALL PHOTOELECTRIC SENSORS

SICK
Sensor Intelligence.



Illustration may differ



Ordering information

Type	Part no.
WSE9C-3P2430A70	1080922

The sensor is equipped with a special Smart Task function. Additional information can be found in the "Technical Data." Use of the sensor for pure object detection is limited.

Other models and accessories → www.sick.com/W9

Detailed technical data

Features

Functional principle	Through-beam photoelectric sensor
Dimensions (W x H x D)	12.2 mm x 52.2 mm x 23.6 mm
Housing design (light emission)	Rectangular
Mounting hole	M3
Sensing range max.	0 m ... 10 m
Sensing range	0 m ... 7 m
Type of light	Visible red light
Light source	PinPoint LED ¹⁾
Light spot size (distance)	Ø 25 mm (1 m)
Wave length	650 nm
Adjustment	IO-Link
Pin 2 configuration	External input, Teach-in input, Detection output, logic output, Device contamination alarm output

¹⁾ Average service life: 100,000 h at T_U = +25 °C.

Mechanics/electronics

Supply voltage U_B	10 V DC ... 30 V DC ¹⁾
Ripple	< 5 V _{pp} ²⁾
Current consumption	30 mA ³⁾
Switching output	PNP ^{4) 5)}
Switching mode	Light/dark switching ⁴⁾
Output current I_{max}	≤ 100 mA ⁶⁾
Response time	< 0.5 ms ⁷⁾
Response time Q/ on Pin 2	300 μs ... 450 μs ^{7) 8)}
Switching frequency	1,000 Hz ⁹⁾
Switching frequency Q / to pin 2	≤ 1,000 Hz ¹⁰⁾
Connection type	Male connector M12, 4-pin
Circuit protection	A ¹¹⁾ B ¹²⁾ C ¹³⁾
Protection class	III
Weight	13 g
Housing material	Plastic, VISTAL®
Optics material	Plastic, PMMA
Enclosure rating	IP66 IP67 IP69K
Test input sender off	Sender off
Ambient operating temperature	-40 °C ... +60 °C
Ambient temperature, storage	-40 °C ... +75 °C
UL File No.	NRKH.E181493
Part number of individual components	2055824 WS9-3D2430, 2088126 WE9C-3P2430A70
Repeatability Q/ on Pin 2:	150 μs ⁸⁾

¹⁾ Limit values when operated in short-circuit protected network: max. 8 A.

²⁾ May not exceed or fall below U_V tolerances.

³⁾ Without load.

⁴⁾ Q = light switching.

⁵⁾ Pin 4: this switching output must not be connected to any other output.

⁶⁾ At and above T_u 50 °C, a max. load current of I_{max} = 50 mA is permitted.

⁷⁾ Signal transit time with resistive load.

⁸⁾ Valid for Q \ on Pin2, if configured with software.

⁹⁾ With light/dark ratio 1:1.

¹⁰⁾ With light / dark ratio 1:1, valid for Q \ on Pin2, if configured with software.

¹¹⁾ A = V_S connections reverse-polarity protected.

¹²⁾ B = inputs and output reverse-polarity protected.

¹³⁾ C = interference suppression.

Safety-related parameters

MTTF_D	693 years
DC_{avg}	0 %

Communication interface

Communication interface	IO-Link V1.1
Communication Interface detail	COM2 (38,4 kBaud)
Cycle time	2.3 ms
Process data length	16 Bit
Process data structure	Bit 0 = switching signal Q _{L1} Bit 1 = switching signal Q _{L2} Bit 2 ... 15 = measuring value
VendorID	26
DeviceID HEX	0x8000E6
DeviceID DEC	8388838

Smart Task

Smart Task name	Time measurement + debouncing
Logic function	Direct WINDOW
Timer function	Deactivated On delay Off delay ON and OFF delay Impulse (one shot)
Inverter	Yes
Time measurement accuracy	SIO Direct: --- ¹⁾ SIO Logic: - 0,7 ... + 0,7 ms ± 0,5 % of time measurement value ²⁾ IOL: - 0,9 ... + 0,9 ms ± 0,5% of the time measurement ³⁾
Time measurement accuracy (e.g. accuracy for time measurement value = 1 s)	SIO Direct: --- ¹⁾ SIO Logic: - 5,7 ... + 5,7 ms ²⁾ IOL: - 5,9 ... + 5,9 ms ³⁾
Resolution time measuring value	1 ms
Min. Time between two process events (switches)	SIO Direct: --- SIO Logic: 450 µs IOL: 500 µs
Debounce time max.	SIO Direct: --- SIO Logic: 30.000 ms IOL: 30.000 ms
Switching signal	Switching signal Q _{L1} Output type (dependant on the adjusted threshold) Switching signal Q _{L2} Output type (dependant on the adjusted threshold)
Measuring value	Time measurement value

¹⁾ SIO Direct: sensor operation in standard I/O mode without IO-Link communication and without using internal sensor logic or time parameters (set to "direct"/"deactivated").

²⁾ SIO Logic: Sensor operation in standard I/O mode without IO-Link communication. Sensor-internal logic or timing parameters plus Automation Functions used.

³⁾ IOL: Sensor operation with full IO-Link communication and usage of logic, timing and Automation Function parameters.

Diagnosis

Device status	Yes
Function reserve	Yes

Classifications

ECLASS 5.0	27270901
-------------------	----------

ECLASS 5.1.4	27270901
ECLASS 6.0	27270901
ECLASS 6.2	27270901
ECLASS 7.0	27270901
ECLASS 8.0	27270901
ECLASS 8.1	27270901
ECLASS 9.0	27270901
ECLASS 10.0	27270901
ECLASS 11.0	27270901
ECLASS 12.0	27270901
ETIM 5.0	EC002716
ETIM 6.0	EC002716
ETIM 7.0	EC002716
ETIM 8.0	EC002716
UNSPSC 16.0901	39121528

Adjustments

No adjustment possibility

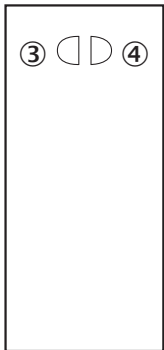

- ③ LED indicator yellow: Status of received light beam
- ④ LED indicator green: power on

Connection type

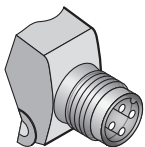

Connection diagram

Cd-365

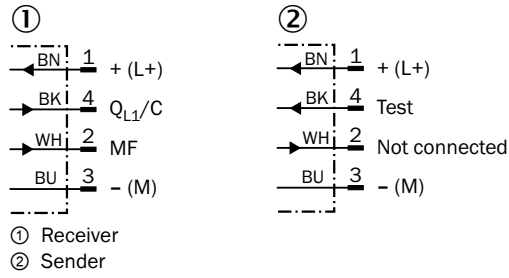

Characteristic curve

WSE9-3, red light, 10 m

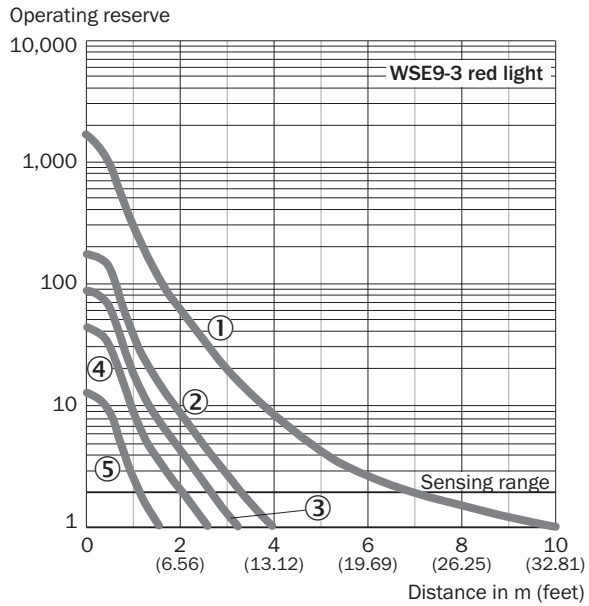

- ① Without masks
- ② With slotted mask, width 2.0 mm
- ③ With slotted mask, width 1.5 mm
- ④ With slotted mask, width 1.0 mm
- ⑤ With slotted mask, width 0.5 mm

Light spot size

WSE9-3, red light, 10 m

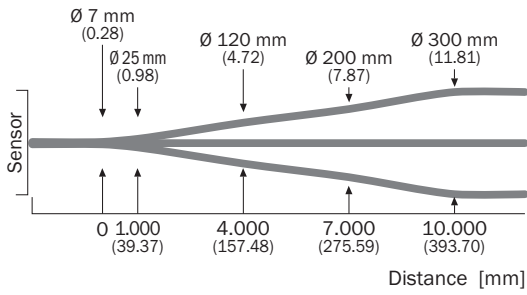

Sensing range diagram

WSE9-3, red light, 10 m

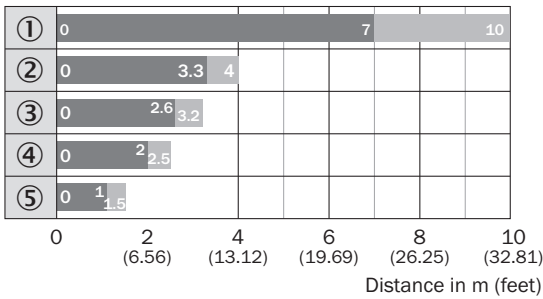

■ Sensing range ■ Sensing range, max. typ.

- ① Without masks
- ② With slotted mask, width 2.0 mm
- ③ With slotted mask, width 1.5 mm
- ④ With slotted mask, width 1.0 mm
- ⑤ With slotted mask, width 0.5 mm

Dimensional drawing (Dimensions in mm (inch))

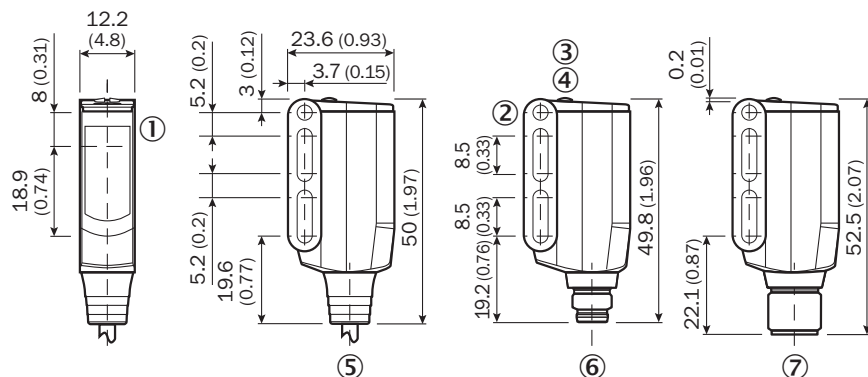

WL9-3, WSE9-3



- ① Sender and receiver optical axis center
- ② Mounting hole M3 (Ø 3.1 mm)
- ③ LED indicator yellow: Status of received light beam
- ④ LED indicator green: power on
- ⑤ Connecting cable or connector
- ⑥ Male connector M8, 4-pin
- ⑦ Male connector M12, 4-pin

Recommended accessories

Other models and accessories → www.sick.com/W9

	Brief description	Type	Part no.
Mounting brackets and plates			
	Mounting bracket, steel, zinc coated, mounting hardware included	BEF-WN-W9-2	2022855
Plug connectors and cables			
	Head A: female connector, M12, 4-pin, straight, A-coded Head B: Flying leads Cable: Sensor/actuator cable, PVC, unshielded, 5 m	YF2A14-050VB3XLEAX	2096235
	Head A: male connector, M12, 4-pin, straight Cable: unshielded	STE-1204-G	6009932

Recommended services

Additional services → www.sick.com/W9

	Type	Part no.
Function Block Factory		
<ul style="list-style-type: none">• Description: The Function Block Factory supports common programmable logic controllers (PLCs) from various manufacturers, such as Siemens, Beckhoff, Rockwell Automation and B&R. More information on the FBF can be found <a _blank"="" href="https://fbf.cloud.sick.com target=">here.• Note: You can configure your function block at <a _blank"="" href="https://fbf.cloud.sick.com target=">Function Block Factory. As a login please use your SICK ID.	Function Block Factory	On request

SICK AT A GLANCE

SICK is one of the leading manufacturers of intelligent sensors and sensor solutions for industrial applications. A unique range of products and services creates the perfect basis for controlling processes securely and efficiently, protecting individuals from accidents and preventing damage to the environment.

We have extensive experience in a wide range of industries and understand their processes and requirements. With intelligent sensors, we can deliver exactly what our customers need. In application centers in Europe, Asia and North America, system solutions are tested and optimized in accordance with customer specifications. All this makes us a reliable supplier and development partner.

Comprehensive services complete our offering: SICK LifeTime Services provide support throughout the machine life cycle and ensure safety and productivity.

For us, that is “Sensor Intelligence.”

WORLDWIDE PRESENCE:

Contacts and other locations –www.sick.com