



WL250-2N2431
W250-2

COMPACT PHOTOELECTRIC SENSORS

SICK
Sensor Intelligence.



Illustration may differ



Ordering information

Type	Part no.
WL250-2N2431	6044696

Included in delivery: BEF-W250 (1), P250 (1)

Other models and accessories → www.sick.com/W250-2

Detailed technical data

Features

Functional principle	Photoelectric retro-reflective sensor
Functional principle detail	Dual lens
Dimensions (W x H x D)	20 mm x 65 mm x 43.9 mm
Housing design (light emission)	Rectangular
Sensing range max.	0.01 m ... 15 m ¹⁾ 0.01 m ... 12 m ²⁾
Sensing range	0.01 m ... 13 m ¹⁾ 0.01 m ... 11 m ²⁾
Focus	Approx. 2°
Type of light	Visible red light
Light source	LED ³⁾
Light spot size (distance)	Ø 260 mm (8 m)
Angle of dispersion	Approx. 2°
Adjustment	Potentiometer, 2 turns ⁴⁾

¹⁾ Reflector PL80A.

²⁾ Reflector P250.

³⁾ Average service life: 100,000 h at T_J = +25 °C.

⁴⁾ With position indicator.

Mechanics/electronics

Supply voltage U_B	10 V DC ... 30 V DC ¹⁾
Ripple	< 5 V _{pp} ²⁾
Current consumption	20 mA ³⁾
Switching output	NPN
Switching mode	Light/dark switching
Switching mode selector	Selectable via L/D control cable
Output current I_{max}	≤ 100 mA
Response time	≤ 0.5 ms ⁴⁾
Switching frequency	1,000 Hz ⁵⁾
Connection type	Male connector M12, 4-pin ⁶⁾
Circuit protection	A ⁷⁾ B ⁸⁾ C ⁹⁾ D ¹⁰⁾
Protection class	III
Weight	40 g
Polarisation filter	✓
Housing material	Plastic, ABS
Optics material	Plastic, PMMA
Enclosure rating	IP67
Items supplied	Reflector P250
Electromagnetic compatibility (EMC)	EN 60947-5-2 ¹¹⁾
Ambient operating temperature	-25 °C ... +55 °C
Ambient temperature, storage	-40 °C ... +70 °C
UL File No.	NRKH2.E300503 & NRKH8.E300503

¹⁾ Limit values when operated in short-circuit protected network: max. 8 A.

²⁾ May not exceed or fall below U_V tolerances.

³⁾ Without load.

⁴⁾ Signal transit time with resistive load.

⁵⁾ With light/dark ratio 1:1.

⁶⁾ Rotatable through 90°.

⁷⁾ A = V_S connections reverse-polarity protected.

⁸⁾ B = inputs and output reverse-polarity protected.

⁹⁾ C = interference suppression.

¹⁰⁾ D = outputs overcurrent and short-circuit protected.

¹¹⁾ The AC/DC devices comply with the Radio Safety Requirements for the industrial sector (Radio Safety Class A). They may cause radio interference if used in a residential area.

Safety-related parameters

MTTF_D	1,751 years
DC_{avg}	0 %

Classifications

ECLASS 5.0	27270902
ECLASS 5.1.4	27270902

WL250-2N2431 | W250-2

COMPACT PHOTOELECTRIC SENSORS

ECLASS 6.0	27270902
ECLASS 6.2	27270902
ECLASS 7.0	27270902
ECLASS 8.0	27270902
ECLASS 8.1	27270902
ECLASS 9.0	27270902
ECLASS 10.0	27270902
ECLASS 11.0	27270902
ECLASS 12.0	27270902
ETIM 5.0	EC002717
ETIM 6.0	EC002717
ETIM 7.0	EC002717
ETIM 8.0	EC002717
UNSPSC 16.0901	39121528

Dimensional drawing (Dimensions in mm (inch))

WL250-2, DC, connector

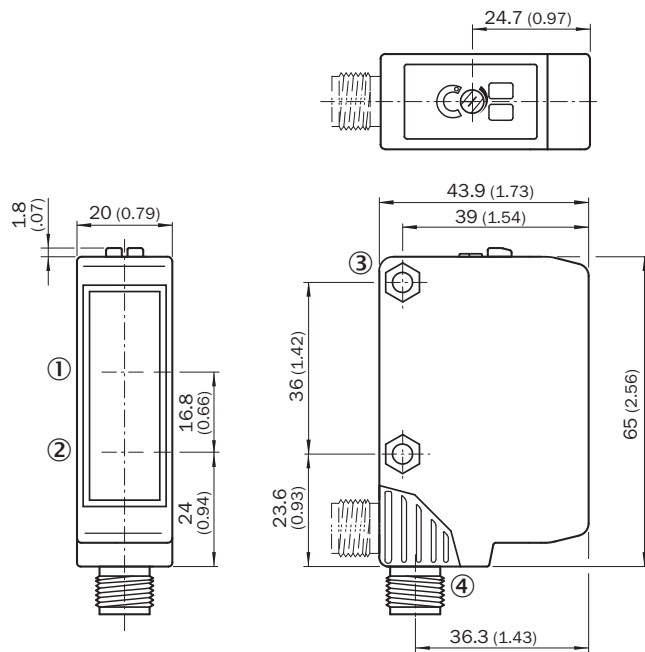

- ① Reception axis
- ② Axis of sender
- ③ Mounting hole \varnothing 4.2 mm, for M4 hexagon nuts on both sides
- ④ Connector M12, 4-pin: Connector position rotatable by 90° (V>H); V: Vertikal final position; H: Horizontal final position, can be locked with slider

Adjustments

WL250-2

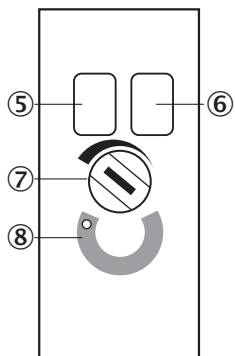

- ⑤ LED indicator green: Stability indicator
- ⑥ LED indicator yellow: Status of received light beam
- ⑦ Sensitivity control: potentiometer
- ⑧ Position indicator for sensitivity setting (270°)

Connection diagram

Cd-087

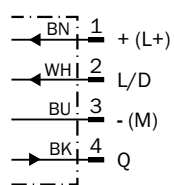

Characteristic curve

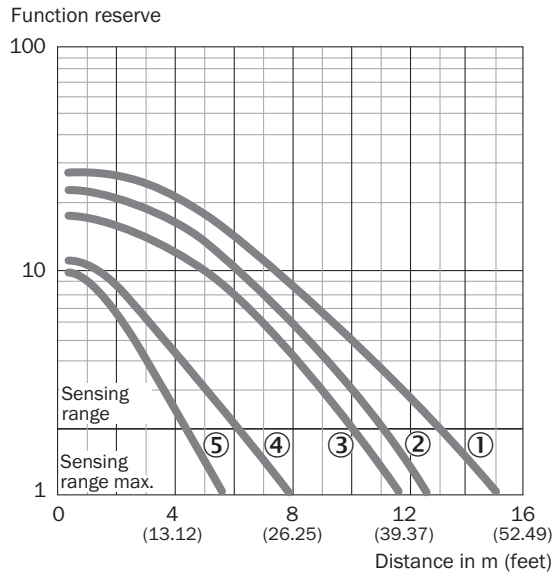

- ① Reflector PL80A, C110A
- ② Reflector P250
- ③ Reflector PL50A, PL40A, PL30A, PL31A
- ④ Reflector PL20A
- ⑤ Diamond Grade reflective tape, 100 mm x 100 mm



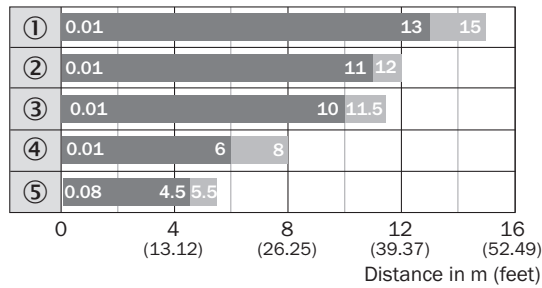

Sensing range diagram



- Sensing range ■ Sensing range max.
- ① Reflector PL80A, C110A
- ② Reflector P250
- ③ Reflector PL50A, PL40A, PL30A, PL31A
- ④ Reflector PL20A
- ⑤ Diamond Grade reflective tape, 100 mm x 100 mm

Recommended accessories

Other models and accessories → www.sick.com/W250-2

	Brief description	Type	Part no.
Mounting brackets and plates			
	Universal mounting bracket for reflectors, steel, zinc coated	BEF-WN-REFX	2064574
Plug connectors and cables			
	<ul style="list-style-type: none"> • Connection type head A: Male connector, M12, 4-pin, straight • Description: Unshielded • Connection systems: Screw-type terminals • Permitted cross-section: ≤ 0.75 mm² 	STE-1204-G	6009932
Reflectors			
	Rectangular, screw connection, 51 mm x 61 mm, PMMA/ABS, Screw-on, 2 hole mounting	P250	5304812
Others			
	<ul style="list-style-type: none"> • Connection type head A: Female connector, M12, 4-pin, straight, A-coded • Connection type head B: Flying leads • Signal type: Sensor/actuator cable • Cable: 5 m, 4-wire, PVC • Description: Sensor/actuator cable, unshielded • Application: Zones with chemicals 	YF2A14-050VB3XLEAX	2096235

SICK AT A GLANCE

SICK is one of the leading manufacturers of intelligent sensors and sensor solutions for industrial applications. A unique range of products and services creates the perfect basis for controlling processes securely and efficiently, protecting individuals from accidents and preventing damage to the environment.

We have extensive experience in a wide range of industries and understand their processes and requirements. With intelligent sensors, we can deliver exactly what our customers need. In application centers in Europe, Asia and North America, system solutions are tested and optimized in accordance with customer specifications. All this makes us a reliable supplier and development partner.

Comprehensive services complete our offering: SICK LifeTime Services provide support throughout the machine life cycle and ensure safety and productivity.

For us, that is “Sensor Intelligence.”

WORLDWIDE PRESENCE:

Contacts and other locations –www.sick.com