

**DISTANCES ET NOMBRE POSTES MAXIMUM INTERPHONE**

	Nbre max de postes	A	B	A + B	C	CONSEIL DE TOUS LES MEMBRÉS DE A. B. & C.		
Câble URMET REF : 1083/90	127	50m	200m	200m	200m	800m	5m	200m
SYTI 0,8mm ou 0,8mm	64	50m	150m	150m	100m	600m	5m	/
CATS UTP	64	50m	125m	125m	100m	800m	5m	/
HVV05-F 1,5mm²	127	50m	125m	125m	50m	300m	5m	/
Câble 1mm²	32	50m	75m	75m	50m	150m	5m	/

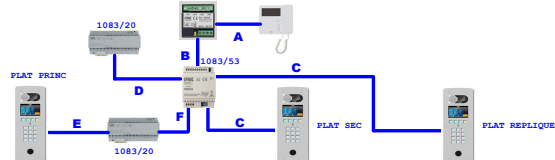

**MATERIEL UTILISABLE SUR CE TYPE D'INSTALLATION :**

- PLAQUE DE RUE VIDEO ZVOICE:  
REF : D83I  
OU REF : D83IG  
OU REF : D83IGLP  
OU REF : D83IGLPP  
OU REF : D83IGPT  
OU REF : D83ILP  
OU REF : D83ILPP  
OU REF : D83IPT  
OU REF : D83ZG  
OU REF : D83ZGLP

- CARTE RELAIS :  
REF : C83/2R

- CÂBLE BUS ZVOICE:  
REF : 1083/90 (100m)  
OU REF : 1083/95 (500m)

- CENTRALE :  
REF : VIT25M  
OU  
REF : VIT25M3

- TÊTE DE LECTURE :  
REF : T25VK2

- ALIMENTATION BUS ZVOICE:  
REF : 1083/20

- DISTRIBUTEUR COLONNE  
REF : 1083/55 (4 sorties)  
OU  
REF : 1083/57 (8 sorties)

- POSTES  
REF : 1183/4  
OU  
REF : 1183/5  
OU  
REF : 1183/7

- BOUTON DE SORTIE  
REF : BA/OF/90LH ou BPZGML  
OU  
REF : AL12/2DIN

**DISTANCES CONTROLE ACCES VIT25M**

	Alim Centrale	Alim Ventouses	Box Plat Sec (BP+ BP-)	Bouton sortie (BP+ BP-)
Câble URMET REF : 1083/90	50m	50m	/	/
Câble 1mm²	50m	50m	/	/
HVV05-F 1,5mm²	100m	100m	/	/
SYTI 0,8mm	25m	25m	100m	100m

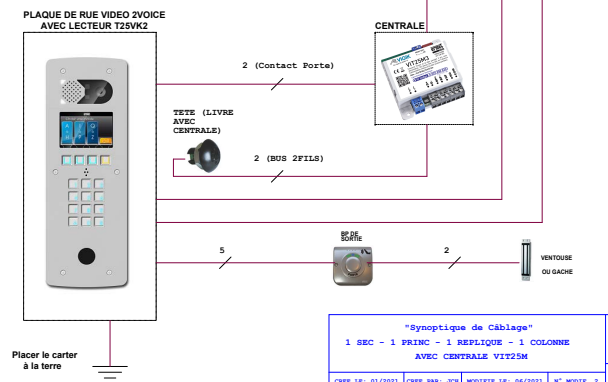
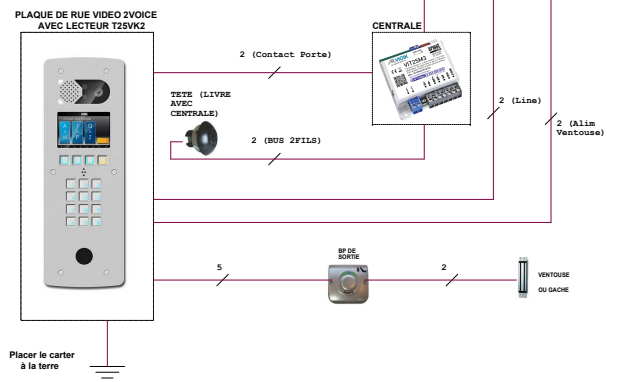
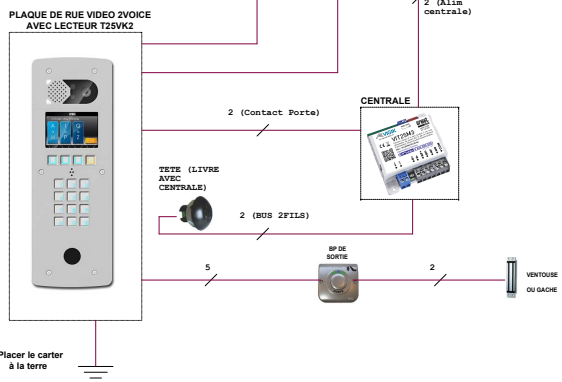
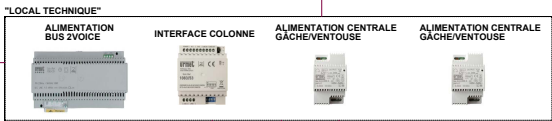
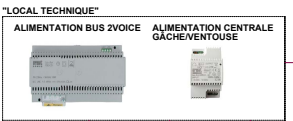
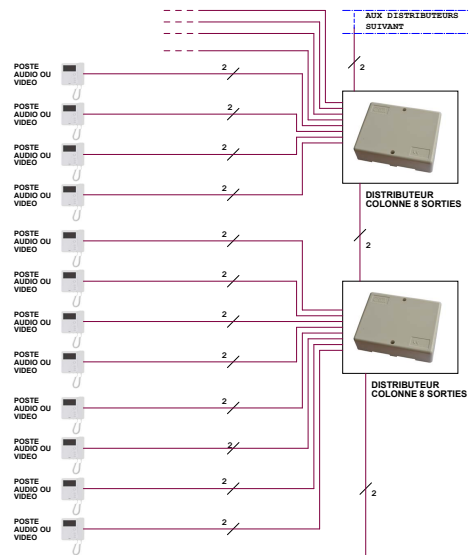

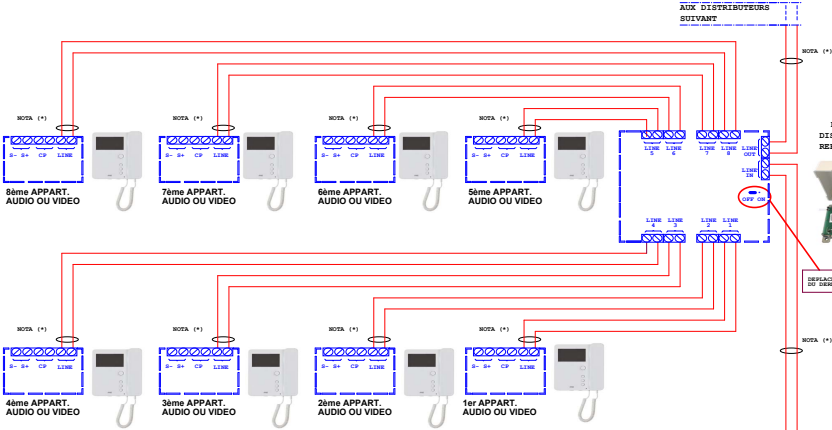

NOTA (\*) :  
 Utiliser un câble indépendant pour cette liaison.  
 Pour la codification des postes, voir la notice de l'alimentation 1083/20, ou télécharger l'application URMET 2 SET.

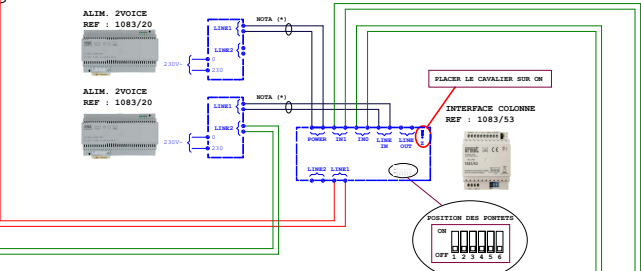
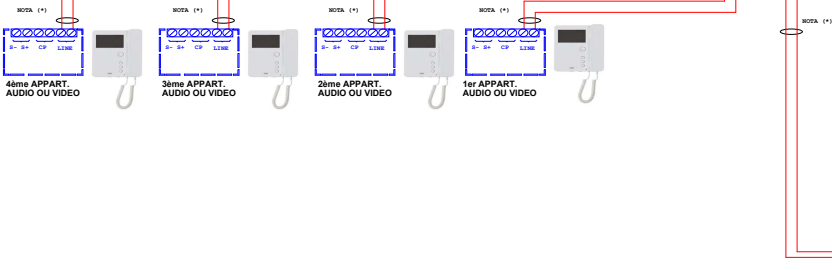

La référence 1083/53 remplace la référence 1083/50. Si vous possédez une 1083/50, il faut reprendre les mêmes bornes que la 1083/53.

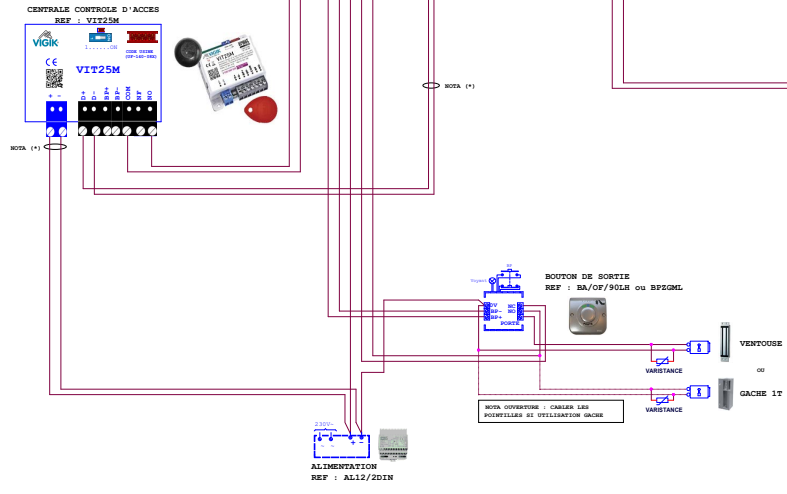
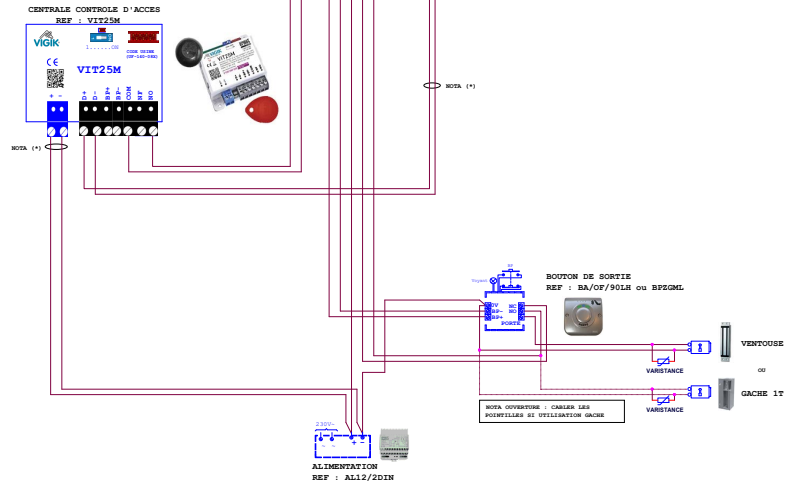
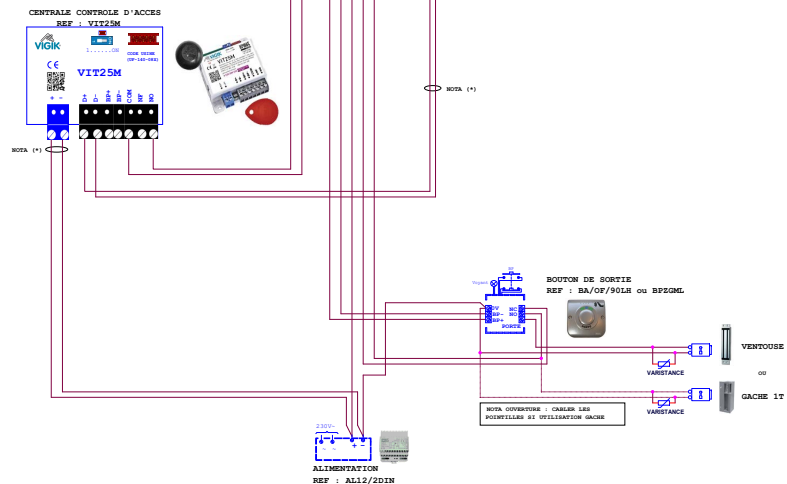
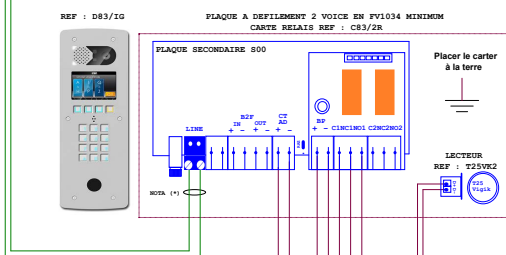
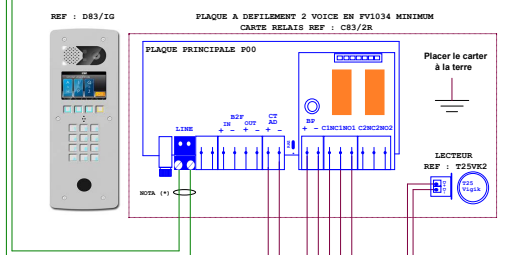
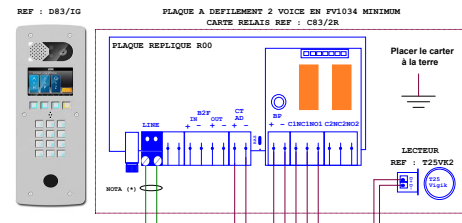

Pour faire fonctionner l'ouverture de porte avec les badges, aller sur le "Menu principale" de la plaque de rue. Puis aller dans "Paramètres" -> "Paramètres porte et relais" -> Mettre "CT(1)/AD(2)/Relai(3)" en position 3 "Rel".