

Alimentation dimmable intégrée

Connexions automatiques repicables

Compatible isolant déroulé et soufflé



## AIRLINE - SPOT LED RT2012 DIMMABLE

Réf : 40072

<b>Puissance :</b>	6W	<b>Indice IP :</b>	I.P 65
<b>T° de couleur :</b>	4000K	<b>Flux lumineux :</b>	600 lm sur 60°
<b>Dimensions :</b>	Ø86x 55mm (spot) 75,7 x 38 x 21mm (bornier) Liaison gainée de 150mm		
<b>Diamètre d'encastrement :</b>	55mm (mini) / 70mm (maxi)	<b>T° de fonctionnement :</b>	-30°C ~ 40°C
<b>Durée de garantie :</b>	5 ans	<b>Durée de vie LED :</b>	50 000h*

\* : Selon données du fabricant des LED

Conforme RT2012

Étanchéité à l'air.

Coloris : Blanc.

Taille compacte

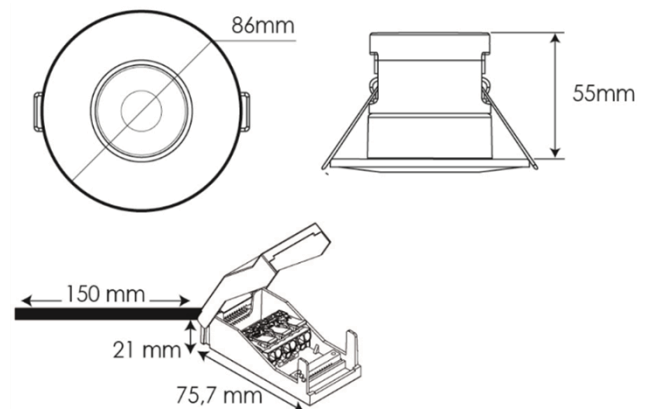

Bornier séparé





- Driver séparé
- Connexions automatiques repicables
- Compatible isolant déroulé et soufflé

**AIRLINE - SPOT LED RT2012 DIMMABLE**

Réf : 40072

**Données photométriques :**

Flux out:301.3 lm

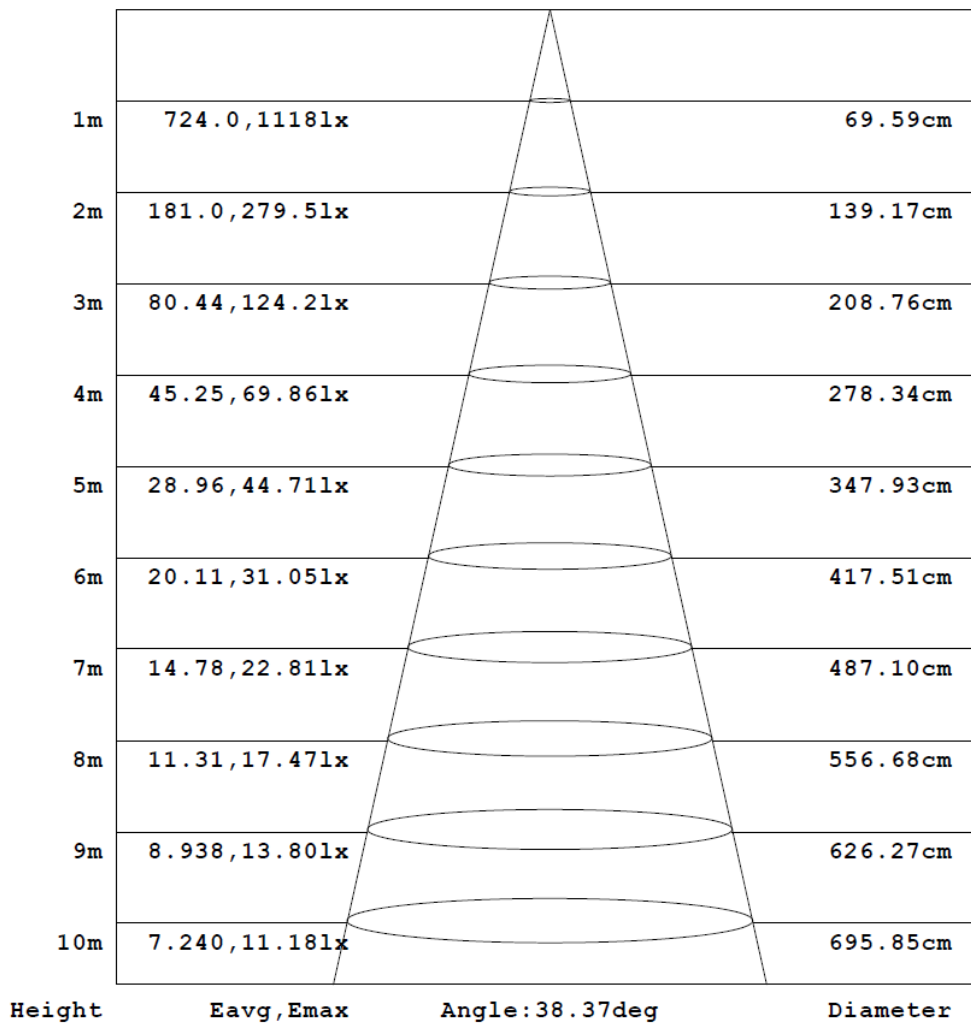

Accessoires : collerette magnétique interchangeable



40075

Alu brossé



40076

Noir mat



40077

Chrome



40078

Blanc

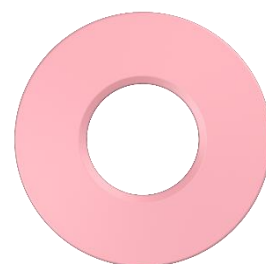

401001

Rose RAL3016

Dimensions: Ø88 x 4mm

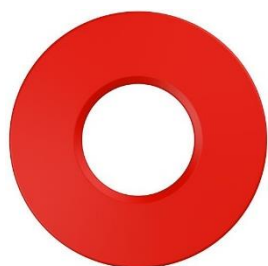

401002

Rouge RAL3021

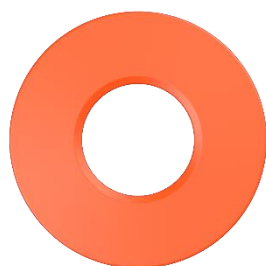

401003

Orange RAL2004

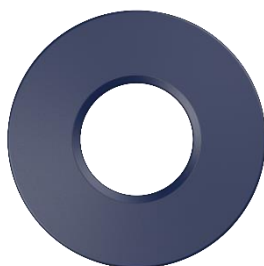

401004

Bleu marine  
RAL5013

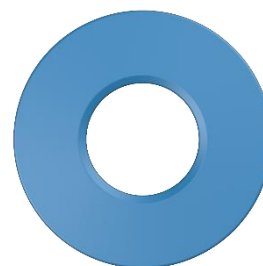

401005

Bleu clair RAL5012



401006

Vert RAL6009

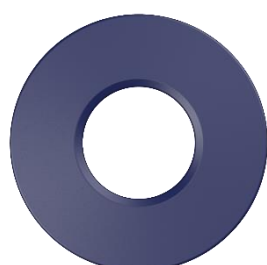

401007

Bleu nuit RAL5022



40079

Alu brossé



40080

Noir mat



40081

Chrome



40082

Blanc

Dimensions: 88 x 88 x 4mm