



Serialnumber

BlackFin

CT-980CH

Instruction Manual

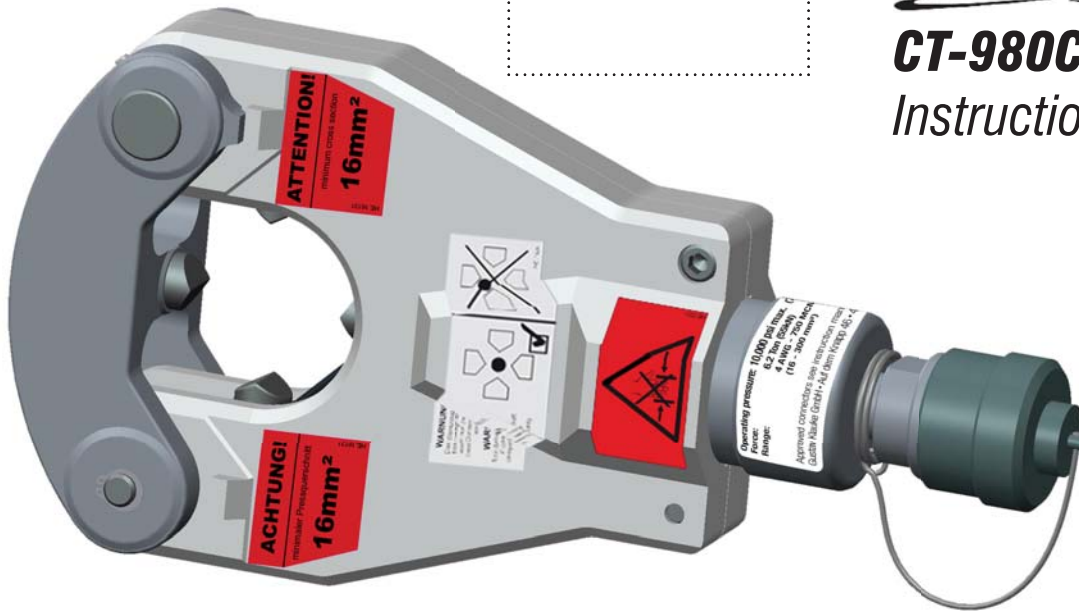



CT-980CH

PANDUIT



HE.17548_B



2 years
Warranty
World wide
Tool
Service
Kleinteile.com



! WARNING

Connections utilizing this tool are U.L. listed and C.S.A. certified only when Panduit compression connectors are used. Use of any other brand of compression connectors is not recommended.

! WARNING

Read all safety warnings, instructions, illustrations and specifications provided with this power tool.

Failure to follow all instructions listed below may result in electric shock, fire and/or serious injury.

Save all warnings and instructions for future reference.





CT-980CH

PANDUIT

1

Operating pressure: 10,000 psi max. (700 bar max.)
 Force: 6.2 Ton (55kN)
 Range: 4 AWG - 750 MCM (16 - 300 mm²)

PANDUIT
CT-980CH Crimp Head

Approved connectors see instruction manual!
 Gustav Klauke GmbH • Auf dem Krapp 46 • 42699 Remscheid • Germany • PK65/VFF/PAN HE.17.637



3

WARNING!
 Das Werkzeug kann beschädigt werden, wenn es verwendet wird, um zu verformen. Dies kann zu einer Beschädigung des Kabels führen.

WARNING!
 This device can be damaged if used to crimp. This may lead to damage to the cable.

4

ACHTUNG! **ATTENTION!**
 minimum cross section **16mm²** **16mm²**
 minimum cross section

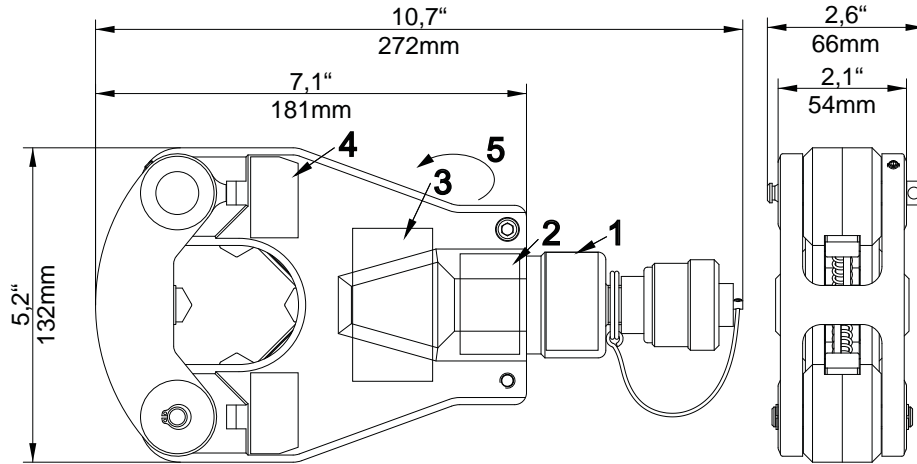
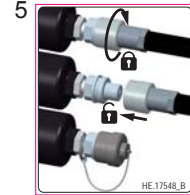

datecode

Year	Code	Month	Code	Month	Code
2016	K	Jan.	N	July	V
2017	L	Feb.	P	Aug.	W
2018	M	Mar.	Q	Sept.	X
2019	N	Apr.	R	Oct.	Y
2020	P	May	S	Nov.	Z
2021	Q	June	T	Dec.	1

304711 batch# e.g. 304711

KS datecode e.g. K = 2016; S = May

142 consecutive# e.g. „142“ = tool # 142

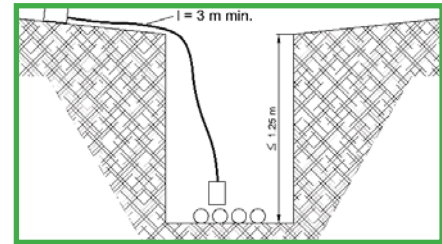
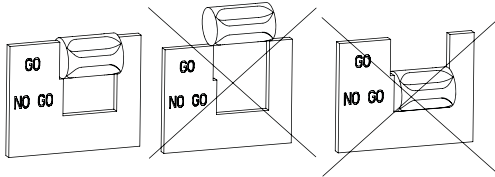



CT-980CH

PANDUIT

1.

2.

3.

4.

3 years or 10.000 cycles

Authorised Service Center

OLD
PART REPLACEMENT
NEW

SAFETY

✓ 1x

• 2x

•• 3x

•••

•••••

Authorised Service Center

EN 50110

✓

Authorised Service Center



MAIL TO:
WEEE-Abholung@
Klaue.Textron.com



CT-980CH

PANDUIT

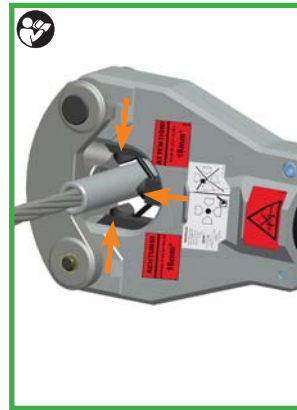
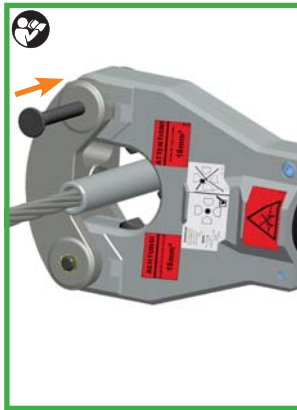
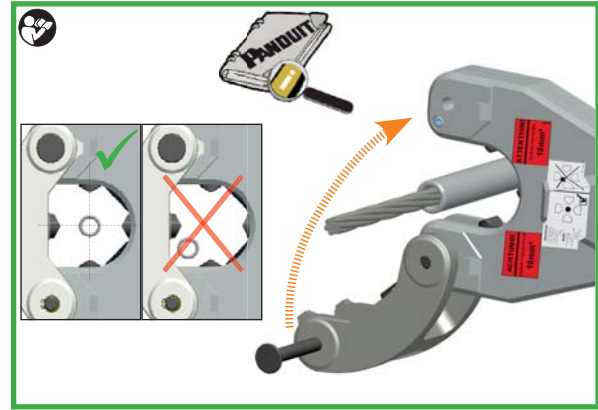
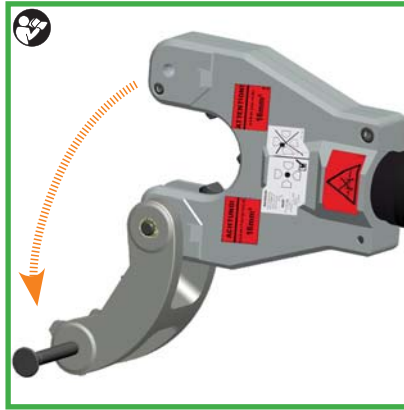

WORK



SERVICE



DON'T DO



Type CT-980CH

Declaration of conformity

(D) CE - Einbauerklärung nach EG-Maschinenrichtlinie 2006/42/EG Anhang II, Nr. 1 B.
Wir erklären in alleiniger Verantwortlichkeit, daß dieses Produkt zum Einbau in Maschinen vorgesehen sind und mit den folgenden Normen oder normativen Dokumenten übereinstimmt: EN ISO 12100-1&2; EN ISO 13857; EN 349; EN 60529; EN 982, EN 1037. Es ist jedoch nicht erlaubt, unsere Produkte in Betrieb zu nehmen, so lange die Maschine, in welche sie eingebaut werden oder von welcher sie ein Teil sind, als Ganzes einschließlich des Produktes, das Gegenstand dieser Deklaration ist, nicht mit den gesetzlichen Vorschriften übereinstimmt.

(GB) CE - Declaration of incorporation in accordance with EC Machinery Directive 2006/42/EC, Annex II, no. 1 B.

We declare under our sole responsibility that this product are intended for incorporation in other machinery and is in conformity with the following standards or normative documents: EN ISO 12100-1&2; EN ISO 13857; EN 349; EN 60529; EN 982, EN 1037. However, our products must not be put into service until the machinery into which they are to be incorporated or of which they are a part has been declared as a whole, including the product that is subject of this declaration, in conformity with legal requirements.

(F) CE - Déclaration d'installation selon la Directive CE Machines 2006/42/CE, Annexe II, no. 1 B.

Nous déclarons sous notre seule responsabilité que ce produit sont prévus pour l'installation dans des machines est en conformité avec les normes ou documents normatifs suivants: EN ISO 12100-1&2; EN ISO 13857; EN 349; EN 60529; EN 982, EN 1037. Il est cependant interdit de mettre nos produits en marche tant que la machine dans laquelle nos produits sont installés ou dont nos produits font partie intégrante, en tant qu'un ensemble contenant le produit qui fait l'objet de cette déclaration, n'est pas conforme aux prescriptions légales.

(NL) CE - Inbouwverklaring volgens EG-machinerichtlijn 2006/42/EG, bijlage II, nr. 1 B.

Wij verklaren en wij stellen ons er alleen voor verantwoordelijk dat dit product gedacht zijn voor de inbouw in machines voldoet aan de volgende normen of normatieve documenten: EN ISO 12100-1&2; EN ISO 13857; EN 349; EN 60529; EN 982, EN 1037. Het is echter niet toegestaan onze producten in bedrijf te stellen, zolang de machine, waarin ze worden ingebouwd of waar ze een deel van zijn, als geheel inclusief het product, dat onderwerp van deze declaratie is, niet in overeenstemming is met de wettelijke voorschriften.

(I) CE - Dichiarazione di incorporazione ai sensi della Direttiva Macchine 2006/42/CE, Appendice II A, No. 1 B.

Dichiariamo sotto la nostra esclusiva responsabilità che questo prodotto sono previsti per l'incorporazione in macchine e è conforme alle seguenti norme e documenti normativi: EN ISO 12100-1&2; EN ISO 13857; EN 349; EN 60529; EN 982, EN 1037. Non è consentito mettere in servizio i nostri prodotti finché la macchina in cui devono essere incorporati o di cui formano parte, come macchina completa incluso il prodotto oggetto della dichiarazione, non soddisfa le norme di legge.

(E) CE - Declaración de incorporación según la Directiva 2006/42/CE de máquinas, Anexo II, nº 1 B.

Declaramos bajo nuestra sola responsabilidad que este producto estan destinados a ser incorporados en otras maquinas está en conformidad con las normas o documentos normativos siguientes: EN ISO 12100-1&2; EN ISO 13857; EN 349; EN 60529; EN 982, EN 1037. Sin embargo, nuestros productos no deberan ser puestos en servicio mientras la maquina final en la que vayan a ser incorporados los productos arriba mencionados o de la cual forman parte no haya sido declarada en su totalidad, junto con el producto al que se refiere esta declaración, conforme a lo dispuesto en la legislación pertinente.

(P) CE - Declaração de incorporação segundo a Diretiva de Máquinas 2006/42/CE, anexo II, n.º 1 B.

Declaramos sob nossa exclusiva responsabilidade que este produto sao previstos para a incorporacao em maquinas cumpre as seguintes normas ou documentos normativos: EN ISO 12100-1&2; EN ISO 13857; EN 349; EN 60529; EN 982, EN 1037. Nao e autorizado colocar nossos produtos em funcionamento se a maquina na qual serao incorporados ou de qual fazem parte nao tenha sido declarada em sua totalidade, junto com o produto objeto desta declaracao, conforme com a legislacao pertinente.

(S) CE - Inmonteringsförläring enligt EG:s maskindirektiv 2006/42/EG, bilaga II, nr. 1 B.

Vi förklarar på eget ansvar att denna produkt avsedd för monteringen i maskiner överensstämmer med följande normer eller normativa dokument: EN ISO 12100-1&2; EN ISO 13857; EN 349; EN 60529; EN 982, EN 1037. Det är dock inte tillåtet att ta vara produkter i drift, så länge den maskin i vilken de skall monteras in till vilken de är en del i sin helhet, inklusive den produkt, som är föremål för denna deklaration inte uppfyller kraven i de lagstadgade bestämmelserna.

(FIN) CE - Asennusvakuutus EY:n koneidirektiivin 2006/42/EY, liite II, nro 1 B, mukaisesti.

Asiasta vastaavana todistamme täten, että tämä tuote on seuraavien standardien ja standardoimisasiakirjojen vaatimusten mukainen: EN ISO 12100-1&2; EN ISO 13857; EN 349; EN 60529; EN 982, EN 1037. Tuotteitamme ei kuitenkaan saa ottaa käyttöön, ennen kuin kone, johon tuotteemme on tarkoitettu asenta tai jonka osia tuotteemme ovat, vastaa yhtenä kokonaisuutena sen tuotteen kanssa, jota tämä vakuutus -koskee, lainmukaisia määräyksiä.

(N) CE - Konformitetserklæring.

Vi erklærer på eget ansvarlighet at dette produkt er i overensstemmelse med følgende standarder eller standard-dokumenter: EN ISO 12100-1&2; EN ISO 13857; EN 349; EN 60529; EN 982, EN 1037. i henhold til bestemmelsene i direktive ne 2006/42/EEC

(DK) CE - Montageerklæring iht. EF-maskindirektiv 2006/42/EF, Bilag II, nr. 1 B.

Vi erklærer under almindeligt ansvar at dette produkt er beregnet til montage i maskiner er i overensstemmelse med følgende normer eller normative dokumenter: EN ISO 12100-1&2; EN ISO 13857; EN 349; EN 60529; EN 982, EN 1037. Det er dog ikke tilladt at tage vores produkter i brug, så længe maskinen, hvori disse monteres eller er del af, som komplet enhed inkl. det produkt, som denne deklaration omhandler, ikke svarer til de lovmæssige bestemmelser.

(PL) CE - Deklaracja włączenia zgodnie z dyrektywą WE w sprawie maszyn 2006/42/WE, załącznik II, nr 1 B.

Świadomi odpowiedzialności oświadczamy, że niniejszy produkt jest zgodny z następującymi normami lub dokumentacją normatywna: EN ISO 12100-1&2; EN ISO 13857; EN 349; EN 60529; EN 982, EN 1037. Nie wolno oddawać naszych produktów do użytku dopóki maszyna, do której mają one być włączone lub której są częścią, jako całość łącznie z produktem, który jest przedmiotem niniejszej deklaracji, nie będzie odpowiadała ustawowemu przepisom.

(GR) CE-10 - ΔΗΛΩΣΗ ΣΥΜΜΟΡΦΩΣΗΣ

Με αναλήψη συνολικής δηλώνουμε: ότι το πορον προϊόν συμφωνεί με τα παρακάτω ποσούτα κα με τα ηροτυπα ηου αναφέρονται στα σχετικό εγγράφα EN ISO 12100-1&2; EN ISO 13857; EN 349; EN 60529; EN 982, EN 1037.

(H) CE – Beépítési nyilatkozat a 2006/42/EU EU-gépirányelv alapján, Függelék II, 1 B sz.:

Teljes felelősséggel kijelentjük, hogy ezek a termékek a következő szabványokkal és irányelvekkel összhangban vannak: EN ISO 12100-1&2; EN ISO 13857; EN 349; EN 60529; EN 982, EN 1037. Termékeink üzembe helyezése addig nem engedélyezett, amíg a gép, amelybe beépítésre kerülnek, vagy amelynek reszét képezik, a termék egészét beleértve, amely ennek a nyilatkozatnak a tárgyát képezi, nem egyezik a törvényes előírásokkal.

(CZ) CE – Prohlášení o montáži podle Smernice ES o strojních zařízeních 2006/42/ES, dodatek II, c. 1 B.

Prohlašujeme na vlastní zodpovědnost, že tyto produkty splňují následující normy nebo normativní listiny: EN ISO 12100-1&2; EN ISO 13857; EN 349; EN 60529; EN 982, EN 1037. Není však dovoleno uvádět naše výrobky do provozu, dokud stroje, do nichž se montují nebo jejichž součástí jsou, jako celek včetně výrobku, který je předmětem této deklarace, nevyhovují zákonným předpisům.

(RO) CE - Declaratie de încorporare în conformitate cu Directiva 2006/42/CE, Anexa II, nr. 1 B.

Noi declarăm pe propria răspundere că acest produs este în conformitate cu următoarele norme și documente normative: EN ISO 12100-1&2; EN ISO 13857; EN 349; EN 60529; EN 982, EN 1037. Se interzice punerea în funcțiune a produselor noastre, cât timp echipamentul în care acestea urmează să fie încorporate sau din care fac ele parte, nu corespunde în ansamblu, inclusiv produsul care este subiectul declarației de fapt, nu corespunde normelor și dispozițiilor legale în vigoare.

(EST) CE - Ühendamisdeklaratsioon EÜ masinaid käsitleva direktiivi 2006/42/EÜ, II lisa, nr 1 B järgi.

Kinnitame, et järgnevas nimetatud tooted või koosteüksused on ette nähtud masinatesse sisse ehitamiseks ja vastavad kõigile masinaid käsitleva direktiivi asjakohastele nõuetele. Kasutatud harmoneeritud standardid: EN ISO 12100-1&2; EN ISO 13857; EN 349; EN 60529; EN 982, EN 1037. Meie toodete kasutusele võtmise ei ole lubatud seni, kuni on kindlaks tehtud, et masin, kuhu need sisse ehitatakse või mille üheks osaks nad on, vastab tervikuna seaduses sätestatud nõuetele, samuti toode, mis on käesoleva deklaratsiooni objektiks.

(LV) CE - Iekļaušanas deklarācija atbilstīgi EK Mašīnu direktīvas 2006/42/EK, II. pielikuma 1. B punktam.

Ar šo apliecinām, ka zemas minētie ražojumi vai to kopumi paredzēti montāžai iekārtas un atbilst visiem saistošajiem noteikumiem atbilstīgi EK Mašīnu direktīvai. Piemēroti šādi saskaņotie standarti: EN ISO 12100-1&2; EN ISO 13857; EN 349; EN 60529; EN 982, EN 1037. Musu ražojumus tomēr nav atļauts ekspluatēt, ja iekārta, kura tie tiek montēti vai kuras sastava tie tiek iekļauti, kopuma nav šīs deklarācijas priekšmets un neatbilst tiesību aktos noteiktajam prasībām.

(LT) CE - Imontavimo Deklaracija pagal EB Mašinu Direktyvos 2006/42/EB II-o priedo Nr. 1 B

Pareiškiami, kad toliau išvardinti gaminiai ar mazgali yra numatyti imontuoti i mašinas ir atitinka visas jiems taikytinas EB Mašinu Direktyvos nuostatas. Taikyti šie darnieji standartai: EN ISO 12100-1&2; EN ISO 13857; EN 349; EN 60529; EN 982, EN 1037. Taciau draudžiama pradėti eksploatuoti musu gaminius tol, kol mašina, i kuria jie turi būti imontuoti arba kurios dalimi jie yra, kaip visuma, neišskiriant ir gaminio, kuriam galioja ši Deklaracija, neatitinka istatymu reikalavimų.

(SLO) CE - Izjava o vgradnji skladno z ES-direktivo o strojih 2006/42/ES, Priloga II, št. 1 B

S tem izjavljamo, da so naslednji proizvodi ali sklopi predvideni za vgradnjo v stroje in izpolnjujejo vsa zadevna določila ES-direktive o strojih. Uporabljene so bile naslednje usklajene norme: EN ISO 12100-1&2; EN ISO 13857; EN 349; EN 60529; EN 982, EN 1037. Zagon naših proizvodov ni dovoljen, dokler stroj, v katerega naj bi bili vgrajeni ali del katerega so, kot celota vključno s proizvodom, ki je predmet te deklaracije, ni v skladu z zakonskimi predpisi.

(SK) CE - Prehlásenie o montáži podľa Smernice ES o strojních zariadeniach 2006/42/ES, dodatok II, c. 1 B

Týmto prehlasujeme, že nasledujúce výrobky alebo konštrukčne celky Su určené pre montáž do strojov a vyhovujú všetkým platným nariadeniam smernice ES o strojnych zariadeniach. Použitie boli nasledujúce harmonizované normy: EN ISO 12100-1&2; EN ISO 13857; EN 349; EN 60529; EN 982, EN 1037. Nie je však dovolene uvádzať naše výrobky do prevádzky dovtedy, pokiaľ stroj, do ktorého sa naše výrobky vmontujú alebo ktorého súčasťou naše výrobky su nebude ako celok vrátane výrobku, ktorý je predmetom tejto deklarácie, vyhovovať zákonným predpisom.

Remscheid, den 04.08.2016

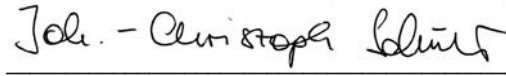







Dipl.-Ing. Joh.-Christoph Schütz, CE-Beauftragter

<p>AUSTRALIA Banyo, QLD 4014</p>  <p>☎ 0061-732128999 ☎ 0061-732128998</p>	<p>AUSTRALIA Canning Vale, WA 6155</p>  <p>☎ 0061-894555574 ☎ 0061-892564075</p>	<p>AUSTRALIA Abbotsford, VIC 3067</p>  <p>☎ 0061-3-94292072 ☎ 0061-3-94297199</p>	<p>AUSTRIA 2544 Leobersdorf</p>  <p>☎ 0043-2256-62925 ☎ 0043-2256-62930</p>
<p>BELGIUM B-1500 Halle</p>  <p>☎ 0032-23570940 ☎ 0032-23549679</p>	<p>BOSNIA-HERZEGOWINA 71000 J'Sarajevo</p>  <p>☎ 00387-33-713060 ☎ 00387-33-7130 63</p>	<p>BRAZIL Sao-Paulo CEP 05501 – 010</p>  <p>☎ 0011-98346-8935 ☎ 0011-2189-5309</p>	<p>CANADA Calgary, T2C0B4</p>  <p>☎ 001-403-291-1121 ☎ 001-403-250-1136</p>
<p>CHINA Nantong, Jiangsu, 221617</p>  <p>☎ 0086-18251309022 ☎ 0086-513 8919 1528</p>	<p>CHINA Shanghai, 200233</p>  <p>☎ 0086-21-58995013 ☎ 0086-21-58995113</p>	<p>CHINA Guangdong, 510095</p>  <p>☎ 0086-20-87323432 ☎ 0086-20-87327792</p>	<p>CHINA Yangzhou City, Jiangsu, 225000</p>  <p>☎ 0086-514-89710085 ☎ 0086-514-89710085</p>
<p>CHINA Chengdu Schuan, 100028</p>  <p>☎ 0086-28-85592749 ☎ 0086-28-85595948</p>	<p>CHINA Liaoning, 116000</p>  <p>☎ 0086-411-84623377 ☎ 0086-411-84633377</p>	<p>CHINA Guang Xi, 530000</p>  <p>☎ 0086-771-2020733 ☎ 0086-771-2020700</p>	<p>CHINA Urumqi, Xinjiang, 830000</p>  <p>☎ 0086-991-8733608 ☎ 0086-991-8728779</p>

<p>CROATIA HR-10000 Zagreb</p>  <p>☎ 00385-12361890 ☎ 00385-12361882</p>	<p>CZECH REPUBLIC / SLOVAKIA 02601 Dolny Kubin</p>  <p>☎ 00421-43-58323-11 ☎ 00421-43-58323-34</p>	<p>DENMARK 2610 Rødovre</p>  <p>☎ 0045-4484-3738 ☎ 0045-4484-3708</p>	<p>FINLAND 20360 Turku</p>  <p>☎ 00358-2-8800020 ☎ 00358-2-8800021</p>
<p>FRANCE 57150 Creutzwald</p>  <p>☎ 0033-3-87298470 ☎ 0033-3-87298479</p>	<p>GERMANY 42855 Remscheid</p>  <p>☎ 0049-2191/907-222 ☎ 0049-2191/907-243</p>	<p>GREECE GR-13671 Athen</p>  <p>☎ 0030-210-240-6000 ☎ 0030-210-240-6007</p>	<p>HUNGARY 2049 Diósd</p>  <p>☎ 0036-23545-140 ☎ 0036-23545-141</p>
<p>INDIA Bangalore, 560064</p>  <p>☎ 0091-9738464980 ☎ 0091-9902322466</p>	<p>INDIA Bangalore, 560064</p>  <p>☎ 0091-9886115506 ☎ 0091-8026914568</p>	<p>INDONESIA Jakarta, 14240</p>  <p>☎ 0062-214534237 ☎ 0062-214534238</p>	<p>INDONESIA Riau Island</p>  <p>☎ 0062-778-455514 ☎ 0062-778-430275</p>
<p>IRLAND Dublin</p>  <p>☎ 0044/07764569582 ☎ 00353-1-4588940</p>	<p>ICELAND 105 Reykjavik</p>  <p>☎ 00354-5886000 ☎ 00354-5886012</p>	<p>ISRAEL 49222 Petach Tikva</p>  <p>☎ 00972-3-9233601 ☎ 00972-3-9234601</p>	<p>ITALY I-43055 Mezzani</p>  <p>☎ 0039-0521-818301 ☎ 0039-0521-818202</p>

<p>JAPAN Kanagawa 236-0037</p>  <p>☎ 0081-45-701-5680 ☎ 0081-45-701-4302</p>	<p>KOREA Seoul 150-093</p>  <p>☎ 0082-2-261409-89 ☎ 0082-2-261409-66</p>	<p>LEBANON 6470 Beirut</p>  <p>☎ 00961-1-385 708 ☎ 00961-1-385 714</p>	<p>LITHUANIA Vilnius LT-03151</p>  <p>☎ 0 0370-5-2311564 ☎ 00370-5-2311564</p>
<p>MALAYSIA 40150 Shan Alam</p>  <p>☎ 00603-78322220 ☎ 00603-77341457</p>	<p>MEXICO C.P. 11850 San Miguel</p>  <p>☎ 0052-55-52719765 ☎ 0052-55-52120413</p>	<p>NETHERLANDS 5321 JZ Hedel</p>  <p>☎ 0031-73-5997599 ☎ 0031-73-5997590</p>	<p>NEW ZEALAND East Tamaki Aukland</p>  <p>☎ 0064-9-2749294 ☎ 0064-9-27308231</p>
<p>NORWAY N-0609 Oslo</p>  <p>☎ 0047-22088100 ☎ 0047-22088101</p>	<p>POLAND 02-921 Warszawa</p>  <p>☎ 0048-22-6428570 ☎ 0048-22-6420505</p>	<p>PORTUGAL Granja-2625-607 Vialonga</p>  <p>☎ 00351-21-3223400 ☎ 00351-21-3223410</p>	<p>ROMANIA 530211 Miercurea Ciuc</p>  <p>☎ 0040-266-372108 ☎ 0040-266-312238</p>
<p>RUSSIA 109147 Moscow</p>  <p>☎ 007-495-7480747 ☎ 007-495-7483735</p>	<p>SERBIA 11000 Beograd</p>  <p>☎ 00381-2417-714 ☎ 00381-2417-715</p>	<p>SINGAPORE Singapore, 569622</p>  <p>☎ 0065-96929681</p>	<p>SLOVENIA 1420 Trbovlje</p>  <p>☎ 00386-356-31800 ☎ 00386-356-31802</p>

<p>SOUTH AFRICA Newlands Johannesburg</p>  <p>☎ 0027-11-2880000 ☎ 0027-11-6732043</p>	<p>SPAIN 28521 Madrid</p>  <p>☎ 0034-917518203 ☎ 0034-917518195</p>	<p>SWEDEN SE-3924 Kalmar</p>  <p>☎ 0046-480-28174 ☎ 0046-480-28165</p>	<p>SWEDEN SE-169 53 Solna</p>  <p>☎ 0046-8202245 ☎ 0046-707550145</p>
<p>SWITZERLAND CH-8964 Rudolfstetten</p>  <p>☎ 0041-56-6492121 ☎ 0041-56-6492141</p>	<p>TAIWAN Teipei, 110</p>  <p>☎ 0084-886227631623 ☎ 0084-886227667492</p>	<p>THAILAND BKK 10400 Bangkok</p>  <p>☎ 00662-6422478-9 ☎ 00662-6423085</p>	<p>TURKEY 34630 Istanbul</p>  <p>☎ 00 90 212 798 25 26 (ext.127) ☎ 00 90 212 798 2530</p>
<p>UKRAINE 36008 Poltava</p>  <p>☎ 0038-0532-500970 ☎ 0038-050-5242646</p>	<p>UNITED KINGDOM Suffolk, NR35 1JX</p>  <p>☎ 0044-1986-891508 ☎ 0044-1986-896132</p>	<p>USA Rockford, Illinois 61109</p>  <p>☎ 001-800-435-0786 ☎ 001-800-451-2632</p>	<p>USA Cleveland, Ohio 44142</p>  <p>☎ 001-216-362-4000 ☎ 001-216-362-4020</p>
<p>USA Brighton, Colorado 80601</p>  <p>☎ 001-720-685-9091 ☎ 001-303-655-8143</p>	<p>USA San Marcos, California 92078</p>  <p>☎ 001-760-735-9793 ☎ 001-760-735-9694</p>	<p>VENEZUELA Caracas</p>  <p>☎ 0058-212-264441 ☎ 0058-212-2644622</p>	<p>VIETNAM Ho Chi Minh City 700000</p>  <p>☎ 0084-8-5120517 ☎ 0084-8-8035359</p>

PANDUIT

Panduit Corp
www.panduit.com/blackfin