

Part number

MKGH V25



Hood, CKH series, with 2 pegs, M25 top cable entry, size "21.21"

Product description		Material properties	
Product type	Hood	Main material	Polyamide (PA)
Series	CKH	Other materials	Gasket: Silicone rubber
Closing type	With 2 pegs	Colour	RAL 7012 grey
Size	Size "21.21"	General ordering information	
Cable entry	Top cable entry M25	EAN13 code	8015747279543
Specification	With gasket	eCl@ss 8.1	27440202
Technical data		ETIM 7.0	EC000437
IP degree of protection	IP44 (IP66/IP67/IP69 with CKRH 65/CKRH 65 D kits)	Packaging Information	
Further technical details		Sub-packaging description	Plastic bag
Weight	11,00 g	Sub-packaging quantity	1 Pcs
Operating temperature range (min, max)	-40°C...+70°C	Sub-packaging EAN barcode	8015747280488

Part number

MKGH V25



Catalogue drawings

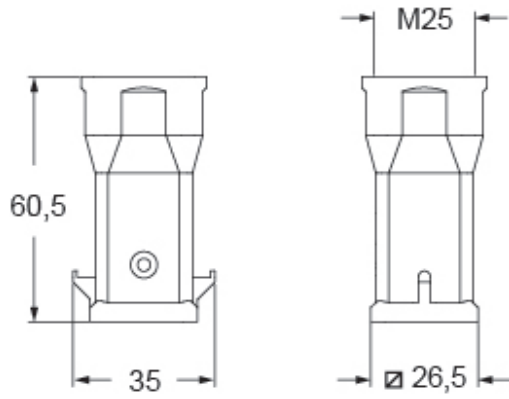

Notes

Dimensions shown in mm are not binding and may be changed without notice.