



Powering Business Worldwide

Instruction Leaflet
Montageanweisung
Notice d'installation
Instrucciones de montaje
Istruzioni per il montaggio
安装说明
Инструкция по монтажу
Montagehandleiding

Montagevejledning
Οδηγίες εγκατάστασης
Instruções de montagem
Monteringsanvisning
Asennusohje
Návod k montáži
Paigaldusjuhend
Szerelési utasítás

Montāžas instrukcija
Montavimo instrukcija
Instrukcja montażu
Navodila za montažo
Návod na montáž
Монтажни инструкции
Instrucțiuni de montaj
Upute za montažu

Kullanma Talimatı
Инструкция за монтаж
Instruksjonsblad
Монтажна інструкція
نشرة التعليمات

FBSmV

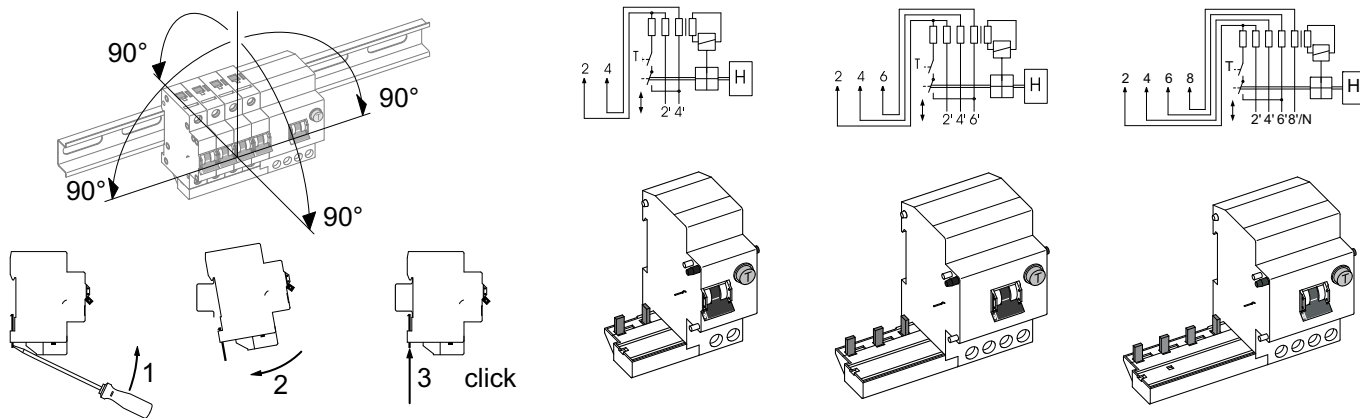

1



FAZ + FBSmV

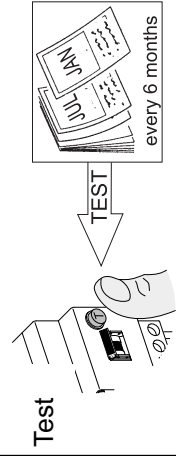
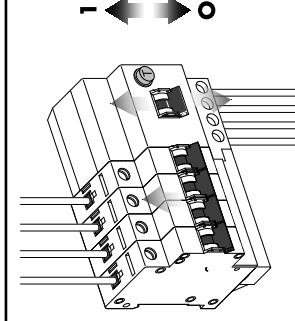
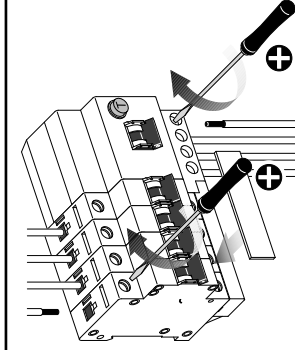
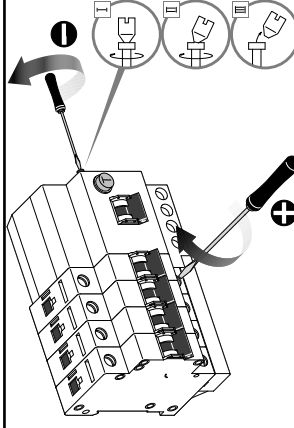
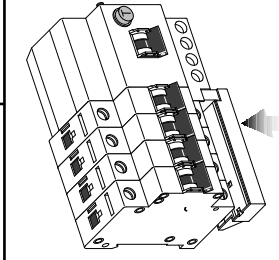
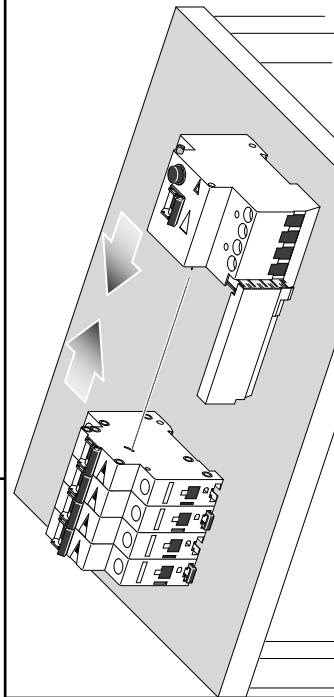
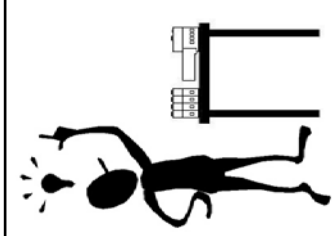
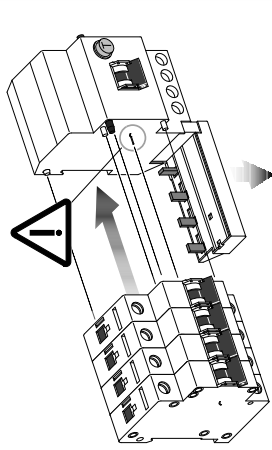
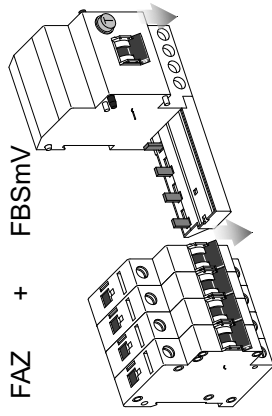

2-2,4Nm **Z2**

0,6Nm

12mm
1-25mm²