

Product designation	Rotary cam switches		
Product type designation	GX32		
General characteristics			
Switching diagram	06 - ON/OFF switch 2 poles		
N° of elements	1		
Mounting form	U25 - Front mounting with red/yellow handle padlockable in 0 and protection covers		
Contact characteristics			
Rated insulation voltage U_i	IEC/EN	V	690
	UL/CSA	V	600
Rated impulse withstand voltage U_{imp}		kV	6
Conventional free air thermal current I_{th}	IEC/EN	A	32
	UL/CSA	A	32
Rated operational voltage		V	440
Rated operational impulse voltage		kV	4
Maximum fuse size for short-circuit protection I_n (gG)	10kA	A	35
	15kA	A	35
	25kA	A	35
Rated short time current I_{cw}		A	1000
	1s	A	1000
Conductivity			10/5 mA/V
Operational current I_e IEC/EN	AC1/AC21A		
		A	32
AC15	110V	A	25
	220/230V	A	20
	380/400V	A	10
	660/690V	A	2
Rated operational power in AC	Three-phase AC-3		
	220/230V	kW	7.5
	380/440V	kW	11
	500/690V	kW	11
	Single-phase AC-3		
	110V	kW	1.8
	220/230V	kW	3.5
	380/440V	kW	5.5
	Three-phase AC23A		
	220/230V	kW	8
	380/440V	kW	15
	500/690V	kW	15
Single-phase AC23A			
110V	kW	2.2	

	220/230V	kW	3.5
	380/440V	kW	6
<hr/>			
Rated operational current in DC			
DC21A			
	48V	A	32
	60V	A	32
	110V	A	5
	220V	A	0.8
	440V	A	0.25
<hr/>			
DC23A (poles in series)			
	24V	A	32 (1)
	48V	A	32 (2)
	60V	A	32 (3)
	110V	A	15 (3)
	220V	A	12 (4)
<hr/>			
DC13			
	24V	A	32
	48V	A	25
	60V	A	14
	110V	A	3
	220V	A	0.5
	440V	A	0.15
<hr/>			
Power dissipation		W	1.6
Mechanical features			
Terminals screw			M4
Tightening torque for terminals max		Nm	1.2
<hr/>			
Conductor size			
AWG - Rigid cable			
	min	AWG	16
	Max	AWG	8
<hr/>			
AWG - Flexible cable			
	min	AWG	16
	Max	AWG	10
<hr/>			
Conductor size (IEC) - Flexible cable			
	min	mm ²	1.5
	Max	mm ²	6
<hr/>			
Conductor size (IEC) - Rigid cable			
	min	mm ²	1.5
	Max	mm ²	10
<hr/>			
Mechanical life		cycles	1X10 ⁶
UL technical data			
Motor power for direct-on-line control			
for three-phase motor			
	120V	HP	3
	240V	HP	7.5
	480V	HP	15
	600V	HP	15
<hr/>			
for single-phase motor			
	120V	HP	1.5
	240V	HP	3
<hr/>			
Ambient conditions			
Temperature			
Operating temperature			
	min	°C	-25

Storage temperature

max °C +55
min °C -40
max °C +70

Resistance & Protection

Frontal IP degree IP65
Terminals IP degree IP20

Dimensions

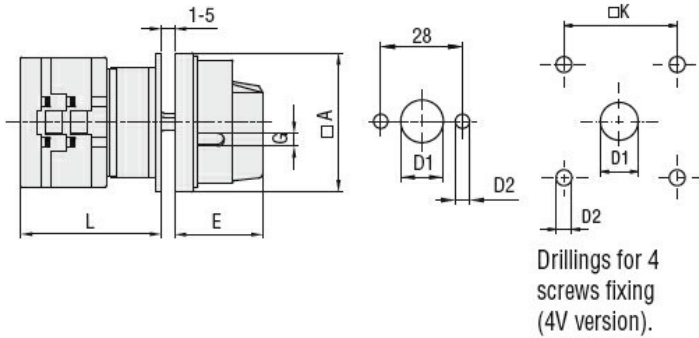

Series	Dimensions						L			
	□A	D1	D2	E	G	□K	1	2	3...12	
GX16	48	12	5	34.2	5	36	43	51.5	60	136.5
GX20	48	12	5	34.2	5	36	43	51.5	60	136.5
GX32	65	14	5	38	6	48	51	63	75	183
GX40	65	14	5	38	6	48	51	63	75	183

Wiring diagrams

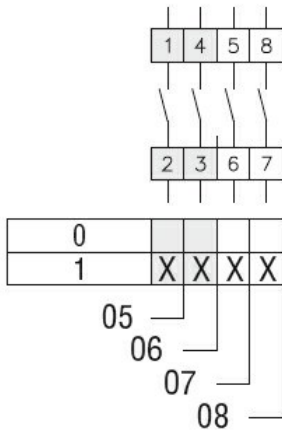

Certifications and compliance

Compliance

CSA C22.2 n° 14
IEC/EN/BS 60947-1
IEC/EN/BS 60947-3
IEC/EN/BS 60947-5-1
IEC/EN/BS 61058-1
UL60947-4-1

Certificates

cULus
EAC

ETIM classification

ETIM 8.0

EC001029 -
Selector switch,
complete