



IMB30-20NN0VC0K

IMB

INDUCTIVE PROXIMITY SENSORS

**SICK**  
Sensor Intelligence.



## Ordering information

Type	Part no.
IMB30-20NNOVCOK	1072855

**Included in delivery:** BEF-MU-M30N (1)

Other models and accessories → [www.sick.com/IMB](http://www.sick.com/IMB)

Illustration may differ



## Detailed technical data

### Features

<b>Housing</b>	Cylindrical thread design
<b>Housing</b>	Short-body
<b>Thread size</b>	M30 x 1.5
<b>Diameter</b>	Ø 30 mm
<b>Sensing range <math>S_n</math></b>	20 mm
<b>Safe sensing range <math>S_a</math></b>	16.2 mm
<b>Installation type</b>	Non-flush
<b>Switching frequency</b>	500 Hz
<b>Connection type</b>	Male connector M12, 4-pin <sup>1)</sup>
<b>Switching output</b>	NPN
<b>Output function</b>	NC
<b>Electrical wiring</b>	DC 3-wire
<b>Enclosure rating</b>	IP68 <sup>2)</sup> IP69K <sup>3)</sup>
<b>Special features</b>	Resistant against coolant lubricants, Visual adjustment indicator, Temperature resistance
<b>Special applications</b>	Zones with coolants and lubricants, Mobile machines, Difficult application conditions
<b>Items supplied</b>	Mounting nut, V2A stainless steel, with locking teeth (2x)

<sup>1)</sup> With gold plated contact pins.

<sup>2)</sup> According to EN 60529.

<sup>3)</sup> According to ISO 20653:2013-03.

## Mechanics/electronics

<b>Supply voltage</b>	10 V DC ... 30 V DC
<b>Ripple</b>	≤ 10 %
<b>Voltage drop</b>	≤ 2 V <sup>1)</sup>
<b>Hysteresis</b>	3 % ... 20 %
<b>Reproducibility</b>	≤ 2 % <sup>2) 3)</sup>
<b>Temperature drift (of S<sub>r</sub>)</b>	± 10 %
<b>EMC</b>	According to EN 60947-5-2
<b>Continuous current I<sub>a</sub></b>	≤ 200 mA
<b>No load current</b>	≤ 10 mA
<b>Short-circuit protection</b>	✓
<b>Reverse polarity protection</b>	✓
<b>Power-up pulse protection</b>	✓
<b>Shock and vibration resistance</b>	100 g / 2 ms / 500 cycles; 150 g / 1 Mio cycles; 10 Hz ... 55 Hz / 1 mm; 55 Hz ... 500 Hz / 60 g
<b>Ambient operating temperature</b>	-40 °C ... +100 °C
<b>Housing material</b>	Stainless steel V2A, DIN 1.4305 / AISI 303
<b>Sensing face material</b>	Plastic, LCP
<b>Housing length</b>	50 mm
<b>Thread length</b>	20 mm
<b>Tightening torque, max.</b>	Typ. 100 Nm <sup>4)</sup> Typ. 100 Nm <sup>5)</sup>
<b>Protection class</b>	III
<b>UL File No.</b>	E181493

<sup>1)</sup> At I<sub>a</sub> max.

<sup>2)</sup> Supply voltage U<sub>B</sub> and constant ambient temperature T<sub>a</sub>.

<sup>3)</sup> Of S<sub>r</sub>.

<sup>4)</sup> When using the non-toothed side of the nut.

<sup>5)</sup> Valid if toothed side of nut is used.

## Safety-related parameters

<b>MTTF<sub>D</sub></b>	1,971 years
<b>DC<sub>avg</sub></b>	0 %

## Reduction factors

<b>Note</b>	The values are reference values which may vary
<b>St37 steel (Fe)</b>	1
<b>Stainless steel (V2A, 304)</b>	Approx. 0.78
<b>Aluminum (Al)</b>	Approx. 0.44
<b>Copper (Cu)</b>	Approx. 0.36
<b>Brass (Br)</b>	Approx. 0.46

## Installation note

<b>Remark</b>	Associated graphic see "Installation"
<b>A</b>	20 mm

<b>B</b>	62 mm
<b>C</b>	30 mm
<b>D</b>	60 mm
<b>E</b>	20 mm
<b>F</b>	160 mm

Classifications

<b>ECLASS 5.0</b>	27270101
<b>ECLASS 5.1.4</b>	27270101
<b>ECLASS 6.0</b>	27270101
<b>ECLASS 6.2</b>	27270101
<b>ECLASS 7.0</b>	27270101
<b>ECLASS 8.0</b>	27270101
<b>ECLASS 8.1</b>	27270101
<b>ECLASS 9.0</b>	27270101
<b>ECLASS 10.0</b>	27270101
<b>ECLASS 11.0</b>	27270101
<b>ECLASS 12.0</b>	27274001
<b>ETIM 5.0</b>	EC002714
<b>ETIM 6.0</b>	EC002714
<b>ETIM 7.0</b>	EC002714
<b>ETIM 8.0</b>	EC002714
<b>UNSPSC 16.0901</b>	39122230

Adjustments

Installation aid

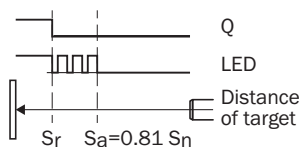

### Installation note

Non-flush installation



### Connection diagram

Cd-008

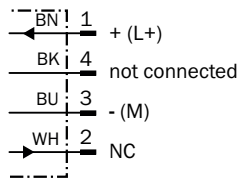

### Response diagram

Response diagram

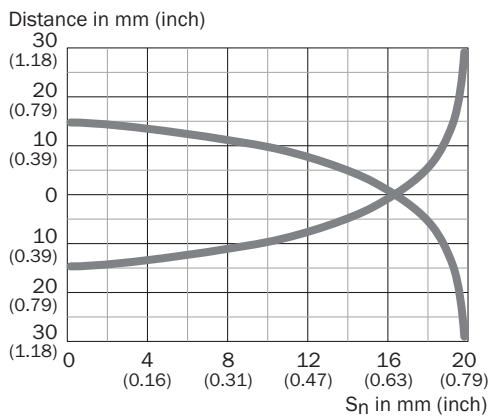

**Dimensional drawing** (Dimensions in mm (inch))

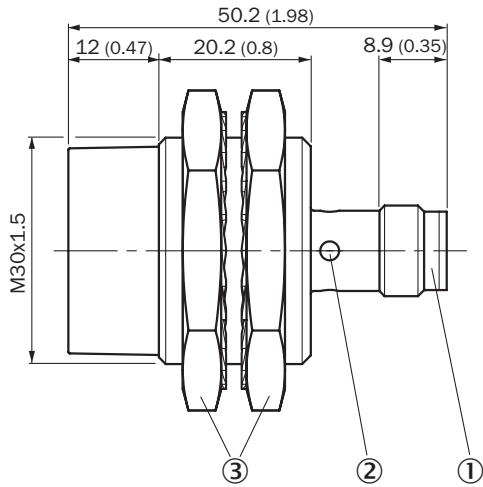

IMB30 Short-body housing, connector M12, non-flush







- ① Connection
- ② Display LED
- ③ Fastening nuts (2 x); width across 36, stainless steel V2A

**Recommended accessories**

Other models and accessories → [www.sick.com/IMB](http://www.sick.com/IMB)

	Brief description	Type	Part no.
<b>Mounting brackets and plates</b>			
	Mounting plate for M30 sensors, steel, zinc coated, without mounting hardware	BEF-WG-M30	5321871
	Mounting bracket for M30 sensors, steel, zinc coated, without mounting hardware	BEF-WN-M30	5308445
<b>Others</b>			
	<ul style="list-style-type: none"> <li>• <b>Connection type head A:</b> Female connector, M12, 4-pin, straight</li> <li>• <b>Connection type head B:</b> Flying leads</li> <li>• <b>Signal type:</b> Sensor/actuator cable</li> <li>• <b>Cable:</b> 2 m, 4-wire, PP</li> <li>• <b>Description:</b> Sensor/actuator cable, unshielded</li> <li>• <b>Connection systems:</b> Flying leads</li> <li>• <b>Note:</b> This product is generally resistant to chemical cleaning agents (see ECOLAB) and other chemical compounds such as H2O2 and CH2O2. Before permanent installation is carried out, the material's resistance to the cleaning agent being used must be checked., Resistant against lactic acid &amp; hydrogen peroxide (H2O2)</li> <li>• <b>Application:</b> Hygienic and washdown zones, Drag chain operation</li> </ul>	DOL-1204-G02MRN	6058291

	Brief description	Type	Part no.
	<ul style="list-style-type: none"> <li>• <b>Connection type head A:</b> Female connector, M12, 4-pin, straight</li> <li>• <b>Connection type head B:</b> Flying leads</li> <li>• <b>Signal type:</b> Sensor/actuator cable</li> <li>• <b>Cable:</b> 5 m, 4-wire, PP</li> <li>• <b>Description:</b> Sensor/actuator cable, unshielded</li> <li>• <b>Connection systems:</b> Flying leads</li> <li>• <b>Note:</b> This product is generally resistant to chemical cleaning agents (see ECOLAB) and other chemical compounds such as H2O2 and CH2O2. Before permanent installation is carried out, the material's resistance to the cleaning agent being used must be checked., Resistant against lactic acid &amp; hydrogen peroxide (H2O2)</li> <li>• <b>Application:</b> Hygienic and washdown zones, Drag chain operation</li> </ul>	DOL-1204-G05MRN	6058476
	<ul style="list-style-type: none"> <li>• <b>Connection type head A:</b> Female connector, M12, 4-pin, angled</li> <li>• <b>Connection type head B:</b> Flying leads</li> <li>• <b>Signal type:</b> Sensor/actuator cable</li> <li>• <b>Cable:</b> 2 m, 4-wire, PP</li> <li>• <b>Description:</b> Sensor/actuator cable, unshielded</li> <li>• <b>Connection systems:</b> Flying leads</li> <li>• <b>Note:</b> This product is generally resistant to chemical cleaning agents (see ECOLAB) and other chemical compounds such as H2O2 and CH2O2. Before permanent installation is carried out, the material's resistance to the cleaning agent being used must be checked., Resistant against lactic acid &amp; hydrogen peroxide (H2O2)</li> <li>• <b>Application:</b> Hygienic and washdown zones, Drag chain operation</li> </ul>	DOL-1204-W02MRN	6058474
	<ul style="list-style-type: none"> <li>• <b>Connection type head A:</b> Female connector, M12, 4-pin, angled</li> <li>• <b>Connection type head B:</b> Flying leads</li> <li>• <b>Signal type:</b> Sensor/actuator cable</li> <li>• <b>Cable:</b> 5 m, 4-wire, PP</li> <li>• <b>Description:</b> Sensor/actuator cable, unshielded</li> <li>• <b>Connection systems:</b> Flying leads</li> <li>• <b>Note:</b> This product is generally resistant to chemical cleaning agents (see ECOLAB) and other chemical compounds such as H2O2 and CH2O2. Before permanent installation is carried out, the material's resistance to the cleaning agent being used must be checked., Resistant against lactic acid &amp; hydrogen peroxide (H2O2)</li> <li>• <b>Application:</b> Hygienic and washdown zones, Drag chain operation</li> </ul>	DOL-1204-W05MRN	6058477
	<ul style="list-style-type: none"> <li>• <b>Connection type head A:</b> Female connector, M12, 4-pin, angled</li> <li>• <b>Connection type head B:</b> Flying leads</li> <li>• <b>Signal type:</b> Sensor/actuator cable</li> <li>• <b>Cable:</b> 2 m, 4-wire, PP</li> <li>• <b>Description:</b> Sensor/actuator cable, unshielded, LED function display</li> <li>• <b>Connection systems:</b> Flying leads</li> <li>• <b>Note:</b> This product is generally resistant to chemical cleaning agents (see ECOLAB) and other chemical compounds such as H2O2 and CH2O2. Before permanent installation is carried out, the material's resistance to the cleaning agent being used must be checked., Resistant against lactic acid &amp; hydrogen peroxide (H2O2), only suitable for PNP sensors</li> <li>• <b>Application:</b> Hygienic and washdown zones, Drag chain operation</li> </ul>	DOL-1204-L02MRN	6058482
	<ul style="list-style-type: none"> <li>• <b>Connection type head A:</b> Female connector, M12, 4-pin, angled</li> <li>• <b>Connection type head B:</b> Flying leads</li> <li>• <b>Signal type:</b> Sensor/actuator cable</li> <li>• <b>Cable:</b> 5 m, 4-wire, PP</li> <li>• <b>Description:</b> Sensor/actuator cable, unshielded, LED function display</li> <li>• <b>Connection systems:</b> Flying leads</li> <li>• <b>Note:</b> This product is generally resistant to chemical cleaning agents (see ECOLAB) and other chemical compounds such as H2O2 and CH2O2. Before permanent installation is carried out, the material's resistance to the cleaning agent being used must be checked., Resistant against lactic acid &amp; hydrogen peroxide (H2O2), only suitable for PNP sensors</li> <li>• <b>Application:</b> Hygienic and washdown zones, Drag chain operation</li> </ul>	DOL-1204-L05MRN	6058483

	Brief description	Type	Part no.
	<ul style="list-style-type: none"> <li>• <b>Connection type head A:</b> Female connector, M12, 4-pin, angled</li> <li>• <b>Connection type head B:</b> Male connector, M12, 4-pin, straight</li> <li>• <b>Signal type:</b> Sensor/actuator cable</li> <li>• <b>Cable:</b> 2 m, 4-wire, PP</li> <li>• <b>Description:</b> Sensor/actuator cable, unshielded</li> <li>• <b>Note:</b> This product is generally resistant to chemical cleaning agents (see ECOLAB) and other chemical compounds such as H2O2 and CH2O2. Before permanent installation is carried out, the material's resistance to the cleaning agent being used must be checked., Resistant against lactic acid &amp; hydrogen peroxide (H2O2)</li> <li>• <b>Application:</b> Hygienic and washdown zones, Drag chain operation</li> </ul>	DSL-1204-B02MRN	6058502
	<ul style="list-style-type: none"> <li>• <b>Connection type head A:</b> Female connector, M12, 4-pin, angled</li> <li>• <b>Connection type head B:</b> Male connector, M12, 4-pin, straight</li> <li>• <b>Signal type:</b> Sensor/actuator cable</li> <li>• <b>Cable:</b> 5 m, 4-wire, PP</li> <li>• <b>Description:</b> Sensor/actuator cable, unshielded</li> <li>• <b>Note:</b> This product is generally resistant to chemical cleaning agents (see ECOLAB) and other chemical compounds such as H2O2 and CH2O2. Before permanent installation is carried out, the material's resistance to the cleaning agent being used must be checked., Resistant against lactic acid &amp; hydrogen peroxide (H2O2)</li> <li>• <b>Application:</b> Hygienic and washdown zones, Drag chain operation</li> </ul>	DSL-1204-B05MRN	6058503
	<ul style="list-style-type: none"> <li>• <b>Connection type head A:</b> Female connector, M12, 4-pin, straight</li> <li>• <b>Connection type head B:</b> Male connector, M12, 4-pin, straight</li> <li>• <b>Signal type:</b> Sensor/actuator cable</li> <li>• <b>Cable:</b> 2 m, 4-wire, PP</li> <li>• <b>Description:</b> Sensor/actuator cable, unshielded</li> <li>• <b>Note:</b> This product is generally resistant to chemical cleaning agents (see ECOLAB) and other chemical compounds such as H2O2 and CH2O2. Before permanent installation is carried out, the material's resistance to the cleaning agent being used must be checked., Resistant against lactic acid &amp; hydrogen peroxide (H2O2)</li> <li>• <b>Application:</b> Hygienic and washdown zones, Drag chain operation</li> </ul>	DSL-1204-G02MRN	6058499
	<ul style="list-style-type: none"> <li>• <b>Connection type head A:</b> Female connector, M12, 4-pin, straight</li> <li>• <b>Connection type head B:</b> Male connector, M12, 4-pin, straight</li> <li>• <b>Signal type:</b> Sensor/actuator cable</li> <li>• <b>Cable:</b> 5 m, 4-wire, PP</li> <li>• <b>Description:</b> Sensor/actuator cable, unshielded</li> <li>• <b>Note:</b> This product is generally resistant to chemical cleaning agents (see ECOLAB) and other chemical compounds such as H2O2 and CH2O2. Before permanent installation is carried out, the material's resistance to the cleaning agent being used must be checked., Resistant against lactic acid &amp; hydrogen peroxide (H2O2)</li> <li>• <b>Application:</b> Hygienic and washdown zones, Drag chain operation</li> </ul>	DSL-1204-G05MRN	6058500
	<ul style="list-style-type: none"> <li>• <b>Connection type head A:</b> Female connector, M12, 4-pin, straight, A-coded</li> <li>• <b>Connection type head B:</b> Male connector, M12, 4-pin, straight, A-coded</li> <li>• <b>Signal type:</b> Sensor/actuator cable</li> <li>• <b>Cable:</b> 5 m, 4-wire, PUR, halogen-free</li> <li>• <b>Description:</b> Sensor/actuator cable, unshielded</li> <li>• <b>Application:</b> Zones with oils and lubricants, Drag chain operation, Robot</li> </ul>	YF2A14-050UB3M2A14	2096001
	<ul style="list-style-type: none"> <li>• <b>Connection type head A:</b> Female connector, M12, 4-pin, straight, A-coded</li> <li>• <b>Connection type head B:</b> Flying leads</li> <li>• <b>Signal type:</b> Sensor/actuator cable</li> <li>• <b>Cable:</b> 2 m, 4-wire, PUR, halogen-free</li> <li>• <b>Description:</b> Sensor/actuator cable, unshielded</li> <li>• <b>Application:</b> Zones with oils and lubricants, Drag chain operation, Robot</li> </ul>	YF2A14-020UB3XLEAX	2095607
	<ul style="list-style-type: none"> <li>• <b>Connection type head A:</b> Female connector, M12, 4-pin, straight, A-coded</li> <li>• <b>Connection type head B:</b> Flying leads</li> <li>• <b>Signal type:</b> Sensor/actuator cable</li> <li>• <b>Cable:</b> 5 m, 4-wire, PUR, halogen-free</li> <li>• <b>Description:</b> Sensor/actuator cable, unshielded</li> <li>• <b>Application:</b> Zones with oils and lubricants, Drag chain operation, Robot</li> </ul>	YF2A14-050UB3XLEAX	2095608



	Brief description	Type	Part no.
	<ul style="list-style-type: none"><li>• <b>Connection type head A:</b> Female connector, M12, 4-pin, angled, A-coded</li><li>• <b>Connection type head B:</b> Flying leads</li><li>• <b>Signal type:</b> Sensor/actuator cable</li><li>• <b>Cable:</b> 5 m, 4-wire, PUR, halogen-free</li><li>• <b>Description:</b> Sensor/actuator cable, unshielded</li><li>• <b>Application:</b> Zones with oils and lubricants, Drag chain operation, Robot</li></ul>	YG2A14-050UB3XLEAX	2095767

## SICK AT A GLANCE

SICK is one of the leading manufacturers of intelligent sensors and sensor solutions for industrial applications. A unique range of products and services creates the perfect basis for controlling processes securely and efficiently, protecting individuals from accidents and preventing damage to the environment.

We have extensive experience in a wide range of industries and understand their processes and requirements. With intelligent sensors, we can deliver exactly what our customers need. In application centers in Europe, Asia and North America, system solutions are tested and optimized in accordance with customer specifications. All this makes us a reliable supplier and development partner.

Comprehensive services complete our offering: SICK LifeTime Services provide support throughout the machine life cycle and ensure safety and productivity.

For us, that is “Sensor Intelligence.”

## WORLDWIDE PRESENCE:

Contacts and other locations –[www.sick.com](http://www.sick.com)