



# VS/VE18-2T2430

V18

CYLINDRICAL PHOTOELECTRIC SENSORS

**SICK**  
Sensor Intelligence.



Illustration may differ



## Ordering information

Type	Part no.
VS/VE18-2T2430	6011381

Other models and accessories → [www.sick.com/V18](http://www.sick.com/V18)

## Detailed technical data

### Features

<b>Functional principle</b>	Through-beam photoelectric sensor
<b>Dimensions (W x H x D)</b>	18 mm x 18 mm x 92 mm
<b>Housing design (light emission)</b>	Cylindrical
<b>Housing length</b>	92 mm
<b>Thread diameter (housing)</b>	M18 x 1
<b>Optical axis</b>	Axial
<b>Sensing range max.</b>	0 m ... 22 m
<b>Sensing range</b>	0 m ... 16 m
<b>Focus</b>	2.9°
<b>Type of light</b>	Infrared light
<b>Light source</b>	LED <sup>1)</sup>
<b>Light spot size (distance)</b>	Ø 800 mm (16 m)
<b>Angle of dispersion</b>	2.9°
<b>Adjustment</b>	None

<sup>1)</sup> Average service life: 100,000 h at T<sub>U</sub> = +25 °C.

### Mechanics/electronics

<b>Supply voltage U<sub>B</sub></b>	20 V AC ... 253 V AC <sup>1)</sup>
<b>Mains frequency</b>	50 Hz, 60 Hz
<b>Current consumption</b>	45 mA <sup>2)</sup>
<b>Switching output</b>	TRIAC
<b>Switching mode</b>	Dark switching
<b>Output current I<sub>max.</sub></b>	≤ 300 mA <sup>3)</sup>

<sup>1)</sup> Limit values.

<sup>2)</sup> Without load.

<sup>3)</sup> Depending on supply voltage VS.

<sup>4)</sup> Signal transit time with resistive load.

<sup>5)</sup> With light/dark ratio 1:1.

<sup>6)</sup> C = interference suppression.

<b>Response time</b>	≤ 20 ms <sup>4)</sup>
<b>Switching frequency</b>	25 Hz <sup>5)</sup>
<b>Connection type</b>	Male connector M12, 4-pin
<b>Circuit protection</b>	C <sup>6)</sup>
<b>Protection class</b>	III
<b>Weight</b>	60 g
<b>Housing material</b>	Plastic, PBT/PC
<b>Optics material</b>	Plastic, PMMA
<b>Enclosure rating</b>	IP67
<b>Ambient operating temperature</b>	-25 °C ... +70 °C
<b>UL File No.</b>	NMFT2.E175606

- 1) Limit values.
- 2) Without load.
- 3) Depending on supply voltage VS.
- 4) Signal transit time with resistive load.
- 5) With light/dark ratio 1:1.
- 6) C = interference suppression.

### Classifications

<b>eCl@ss 5.0</b>	27270901
<b>eCl@ss 5.1.4</b>	27270901
<b>eCl@ss 6.0</b>	27270901
<b>eCl@ss 6.2</b>	27270901
<b>eCl@ss 7.0</b>	27270901
<b>eCl@ss 8.0</b>	27270901
<b>eCl@ss 8.1</b>	27270901
<b>eCl@ss 9.0</b>	27270901
<b>eCl@ss 10.0</b>	27270901
<b>eCl@ss 11.0</b>	27270901
<b>eCl@ss 12.0</b>	27270901
<b>ETIM 5.0</b>	EC002716
<b>ETIM 6.0</b>	EC002716
<b>ETIM 7.0</b>	EC002716
<b>ETIM 8.0</b>	EC002716
<b>UNSPSC 16.0901</b>	39121528

### Connection type

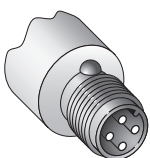

Connection diagram

Cd-223

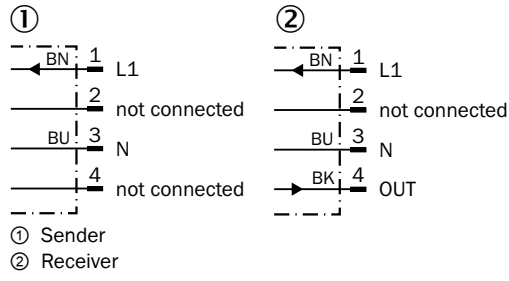

Characteristic curve

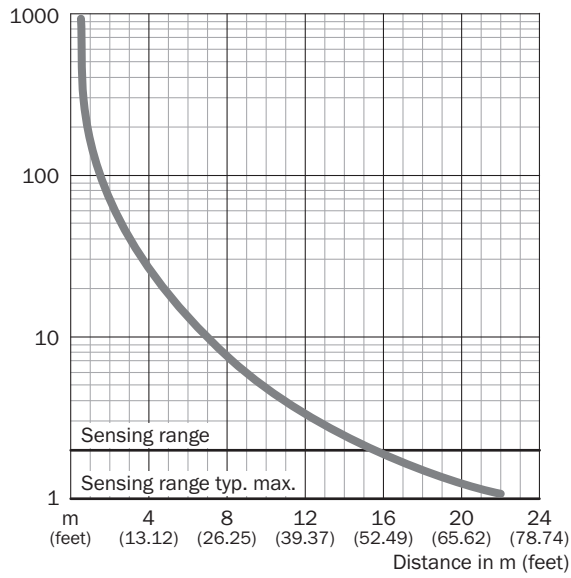

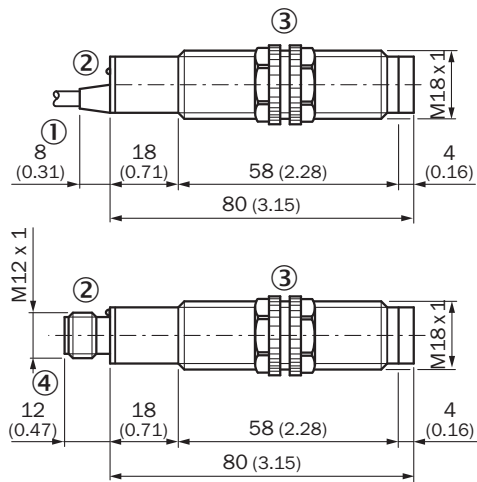

Dimensional drawing (Dimensions in mm (inch))



- ① Connection cable
- ② LED signal strength indicator
- ③ Fastening nuts, 22 mm hex (included)
- ④ Connector M12, 4-pin

Recommended accessories

Other models and accessories → [www.sick.com/V18](http://www.sick.com/V18)

	Brief description	Type	Part no.
<b>Mounting brackets and plates</b>			
	Mounting bracket for M18 sensors, steel, zinc coated, without mounting hardware	BEF-WN-M18	5308446
<b>Plug connectors and cables</b>			
	Head A: female connector, M12, 4-pin, straight, A-coded Head B: Flying leads Cable: Sensor/actuator cable, PVC, unshielded, 5 m	YF2A14-050VB3XLEAX	2096235
	Head A: male connector, M12, 4-pin, straight Cable: unshielded	STE-1204-G	6009932

## SICK AT A GLANCE

SICK is one of the leading manufacturers of intelligent sensors and sensor solutions for industrial applications. A unique range of products and services creates the perfect basis for controlling processes securely and efficiently, protecting individuals from accidents and preventing damage to the environment.

We have extensive experience in a wide range of industries and understand their processes and requirements. With intelligent sensors, we can deliver exactly what our customers need. In application centers in Europe, Asia and North America, system solutions are tested and optimized in accordance with customer specifications. All this makes us a reliable supplier and development partner.

Comprehensive services complete our offering: SICK LifeTime Services provide support throughout the machine life cycle and ensure safety and productivity.

For us, that is “Sensor Intelligence.”

## WORLDWIDE PRESENCE:

Contacts and other locations –[www.sick.com](http://www.sick.com)