



E-Pac  EKEPRHLT5H



Daikin Altherma ST



Daikin Altherma 3 R W  
Daikin Altherma 3 H HT W  
Daikin Altherma 3 H W

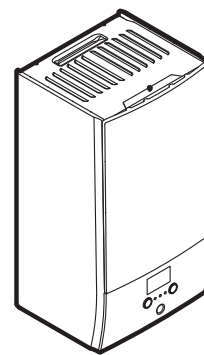

Daikin Altherma R W

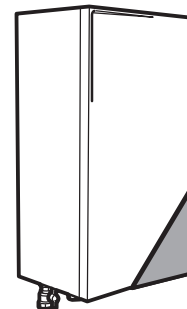

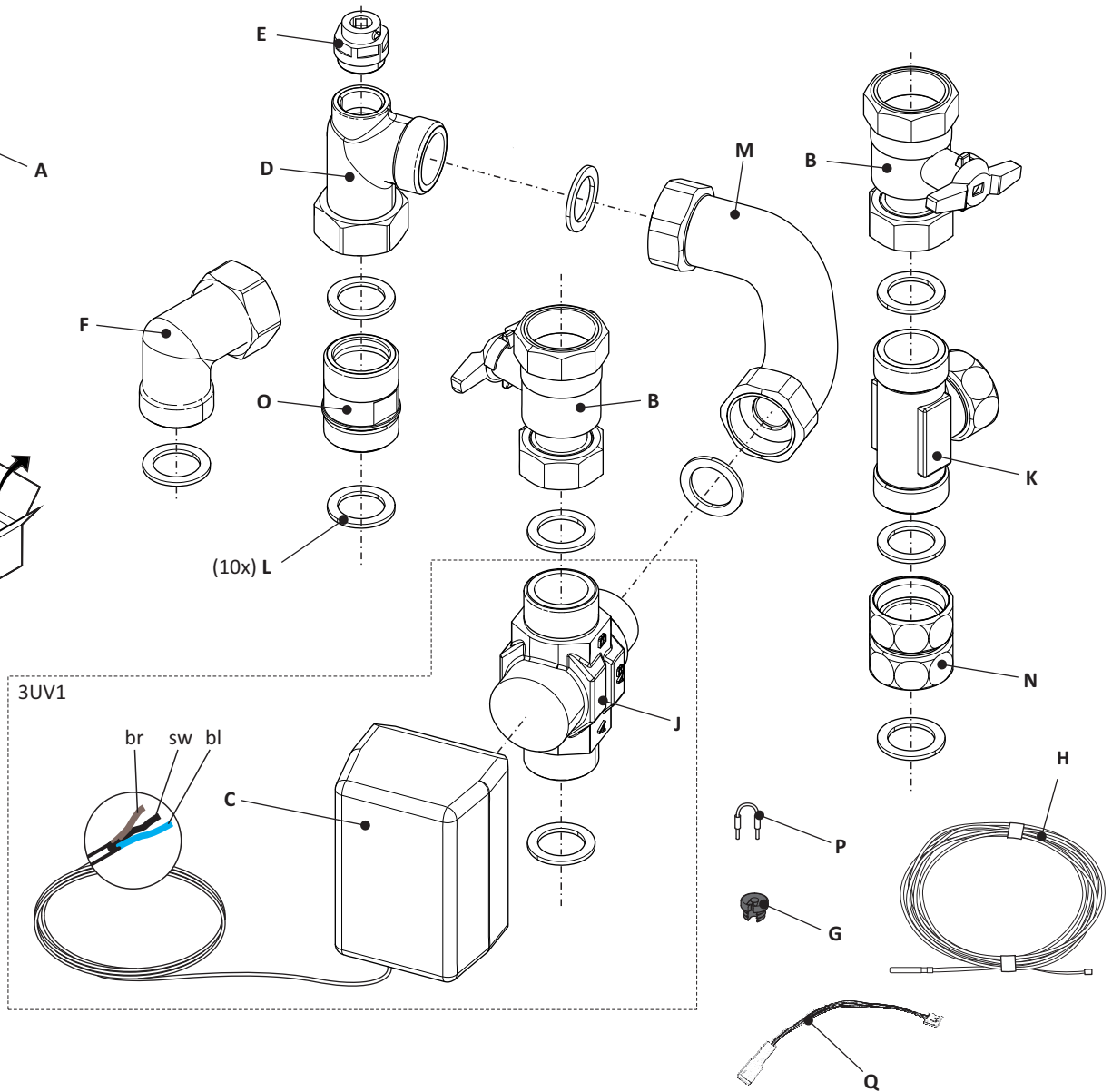
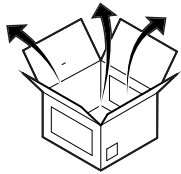

	EN	DE	NL	IT	ES	FR
A	Documentation	Dokumentation	Documentatie	Documentazione	Documentación	Documentation
B	Ball valve 1"	Kugelhahn 1"	Kogelkraan 1"	Valvola a sfera 1"	Válvula de bola 1"	Robinet á boisseau sphérique 1"
C	Actuator switch valve	Antrieb Umschaltventil	Actuator schakelklep	Attuatore valvola	Actuador válvula	Moteur vanne d'inversion
D	Angle bracket 1"	Winkel 1"	Hoeksteun 1"	Angolare 1"	Codo 1"	Coude 1"
E	Manuel vent	Handentlüfter	Manuele ontluichter	Disareatore	Purgador manual	Purgeur manuel
F	Angle bracket 1"	Winkel 1"	Hoeksteun 1"	Angolare 1"	Codo 1"	Coude 1"
G	Sensor plug	Fühlerstopfen	Sensor plug	Connettore sonda	Tapón del sensor	Bouchon sonde
H	Storage tank sensor	Speicherfühler	Opslagtank sensor	Sensore accumulo	Sonda ACS	Sonde ballon
J	Switching valve 1"	Umschaltventil 1"	Omschakelkleb 1"	Valvola deviatrice 1"	Válvula de conmutación 1"	Vanne d'inversion 1"
K	T-pipe 1"	T-Stück 1"	T-pijp 1"	Raccordo T 1"	Racor "TE" 1"	Raccord en T 1"
L	Flat seal 1"	Flachdichtung 1"	Vlakke dichting 1"	Guarnizione piana	Junta plana 1"	Joint plat
M	Corrugated pipe	Wellrohr	Gedolfdepijp	Tubo corrugato	Tubo corrugado	Tube annelé
N	Connection pipe 1"	Verbindungsstück 1"	Aansluitleiding 1"	Tubo di connessione 1"	Racor de conexión 1"	Raccord de connexion 1"
O	Threaded pipe fitting 1"	Doppelnippel 1"	Schroefdraadbuis fitting 1"	Raccordo filettato 1"	Racor de conexión 1"	Raccord de connexion 1"
P	STB-Bridge	STB-Brücke	STB-brug	STB-Ponte	STB-Puente	STB-pont
Q	Adapter cable	Adapterkabel	Adapterkabel	Cavo di adattamento	Cable adaptador	Câble adaptateur
br	brown	braun	bruin	marrone	marrón	marron
sw	black	schwarz	zwart	nero	negro	noir
bl	blue	blau	blauw	blu	azul	bleu

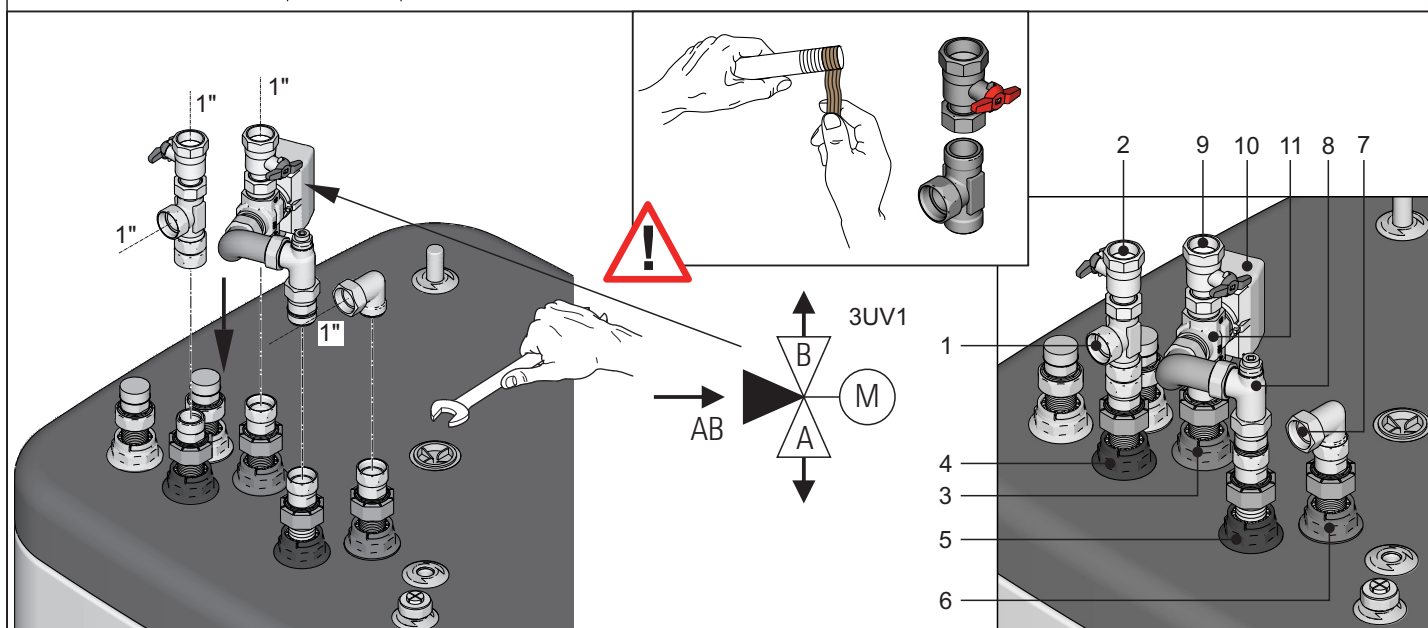
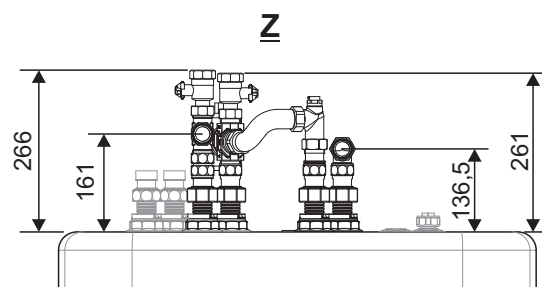
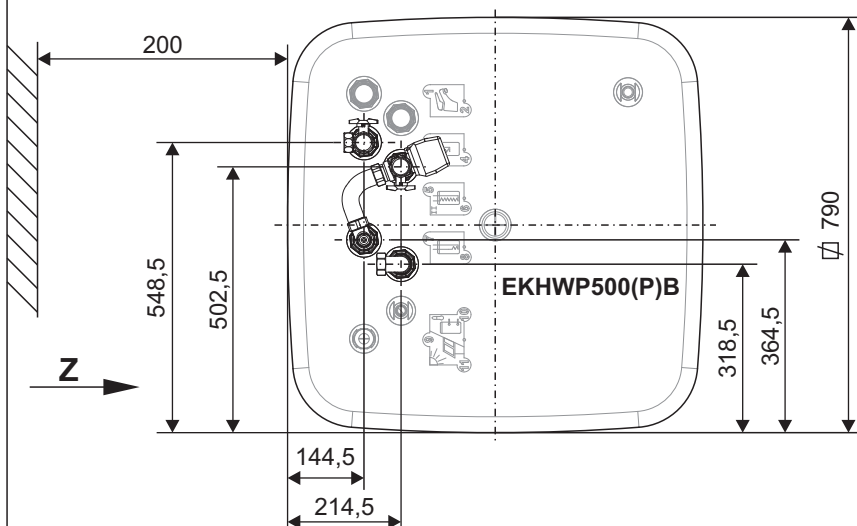

	EN	DE	NL	IT	ES	FR
1	Return Daikin Altherma	Rücklauf Daikin Altherma	Terugkeer Daikin Altherma	Ritorno Daikin Altherma	Retorno Daikin Altherma	Retour Daikin Altherma
2	Return central heating	Rücklauf Heiznetz	Terugkeer centrale verwarming	Ritorno rete di riscaldamento	Retorno red de calefacción	Retour réseau de chauffage
3	Flow storage tank charging	Speicherladung Vorlauf	Stroom opslagtank laden	Mandata caricamento del bollitore	Carga del acumulador, impulsión	Charge du ballon départ
4	Return storage tank charging	Speicherladung Rücklauf	Terugkeer obslagtank laden	Ritorno caricamento del bollitore	Carga del acumulador, retorno	Charge du ballon retour
5	Return heating support	Heizungsunterstützung Rücklauf	Terugkeer hulpverwarming	Ritorno riscaldamento ausiliario	Apoyo calefacción, retorno	Appoint de chauffage retour
6	Flow heating support	Heizungsunterstützung Vorlauf	Stroom hulpverwarming	Mandata riscaldamento ausiliario	Apoyo calefacción, impulsión	Appoint de chauffage départ
7	Flow Daikin Altherma	Vorlauf Daikin Altherma	Stroom Daikin Altherma	Mandata Daikin Altherma	Impulsión Daikin Altherma	Départ Daikin Altherma
8	Angle bracket with manual vent	Winkel mit Handentlüfter	Hoeksteun met manuele ontlufter	Angolare con sfiatatoio manuale	Codo con purgador de aire manual	Equerre avec purge manuelle
9	Flow central heating	Vorlauf Heiznetz	Stroom centrale verwarming	Mandata rete riscaldamento	Impulsión red de calefacción	Départ réseau de chauffage
10	3-way switch valve 3UV1	3-Wege-Umschaltventil 3UV1	3-weg omschakelkleb 3UV1	Valvola selettiva a 3 vie 3UV1	Válvula de conmutación de 3 vías 3UV1	Vanne d'inversion 3-voies 3UV1
11	Valve body	Ventilkörper	Kleplichaam	Corpo valvola	Cuerpo de la válvula	Corps de vanne



Y

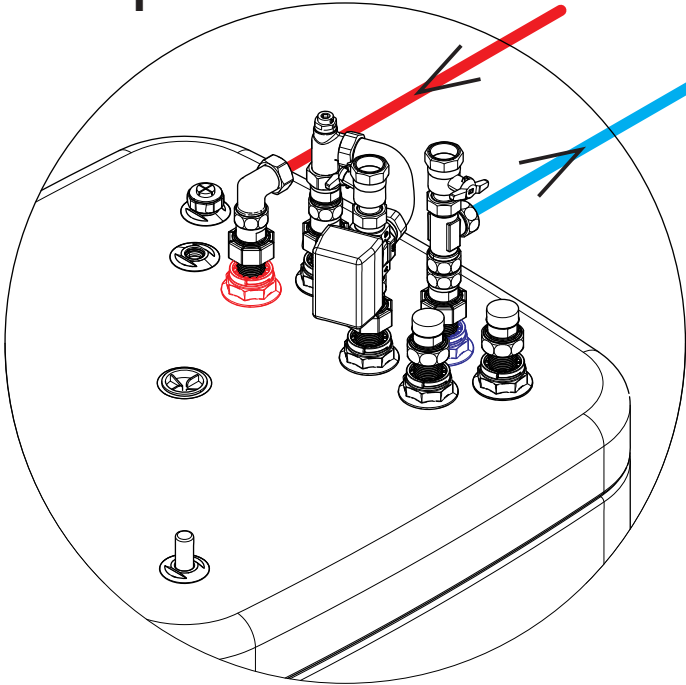

Daikin Altherma 3 R W  
Daikin Altherma 3 H HT W  
Daikin Altherma 3 H W

EBH-D  
ETBH-D  
EABH-D

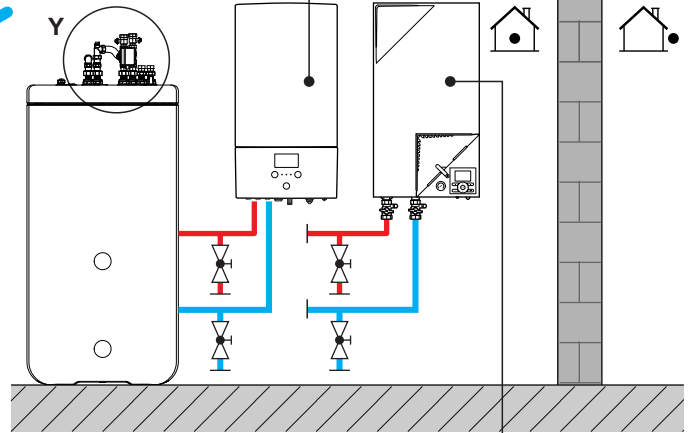

Daikin Altherma R W

EHBH-CB



Daikin Altherma R W  
Daikin Altherma 3 R W  
Daikin Altherma 3 H HT W  
Daikin Altherma 3 H W

Daikin Altherma ST

EHBH-D / ETBH-D / EABH-D

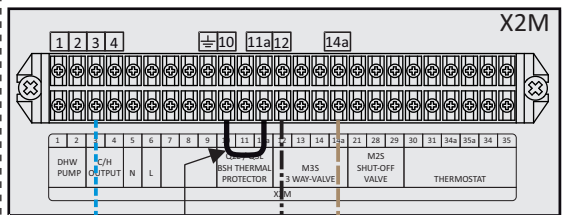

P

3 | 12 | 14a  
bl | sw | br

3UV1  
(CH/DHW)

EHBH-CB

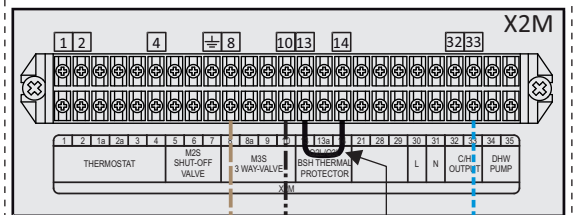

P

8 | 10 | 33  
br | sw | bl

3UV1  
(CH/DHW)

EKEPRHLT5H

br	brown	braun	bruin	marrone	marrón	marron
sw	black	schwarz	zwart	nero	negro	noir
bl	blue	blau	blauw	blu	azul	bleu



Daikin Altherma 3 R W  
 Daikin Altherma 3 H HT W  
 Daikin Altherma 3 H W

EBBH-D  
 ETBH-D  
 EABH-D

Daikin Altherma R W EBBH-CB

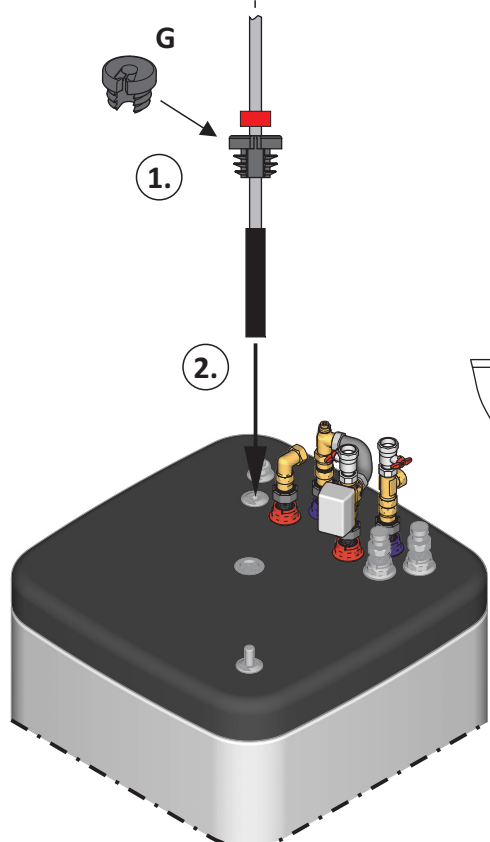
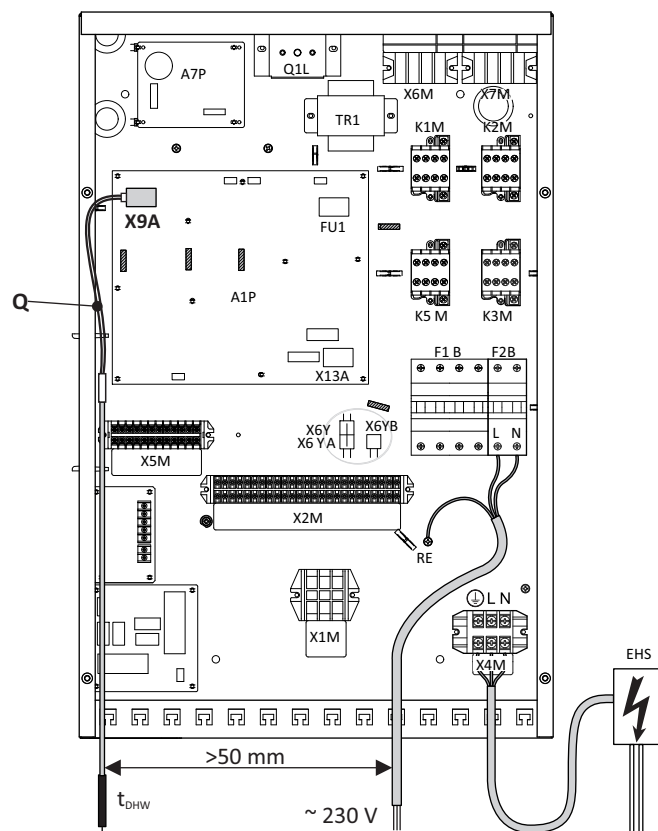
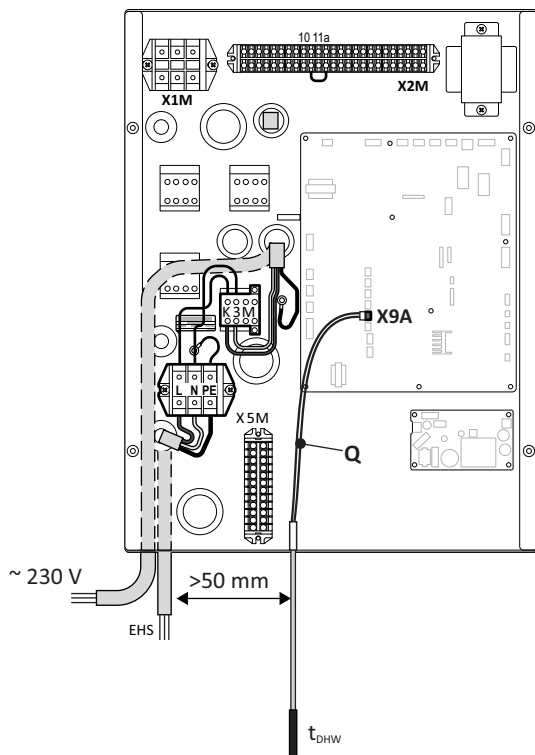

1.

2.

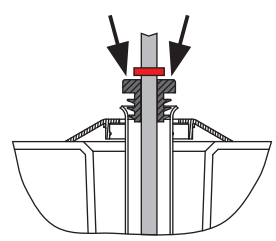

3.

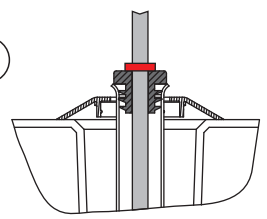

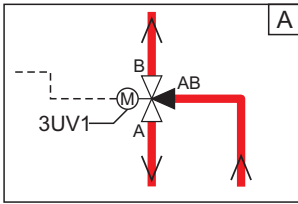
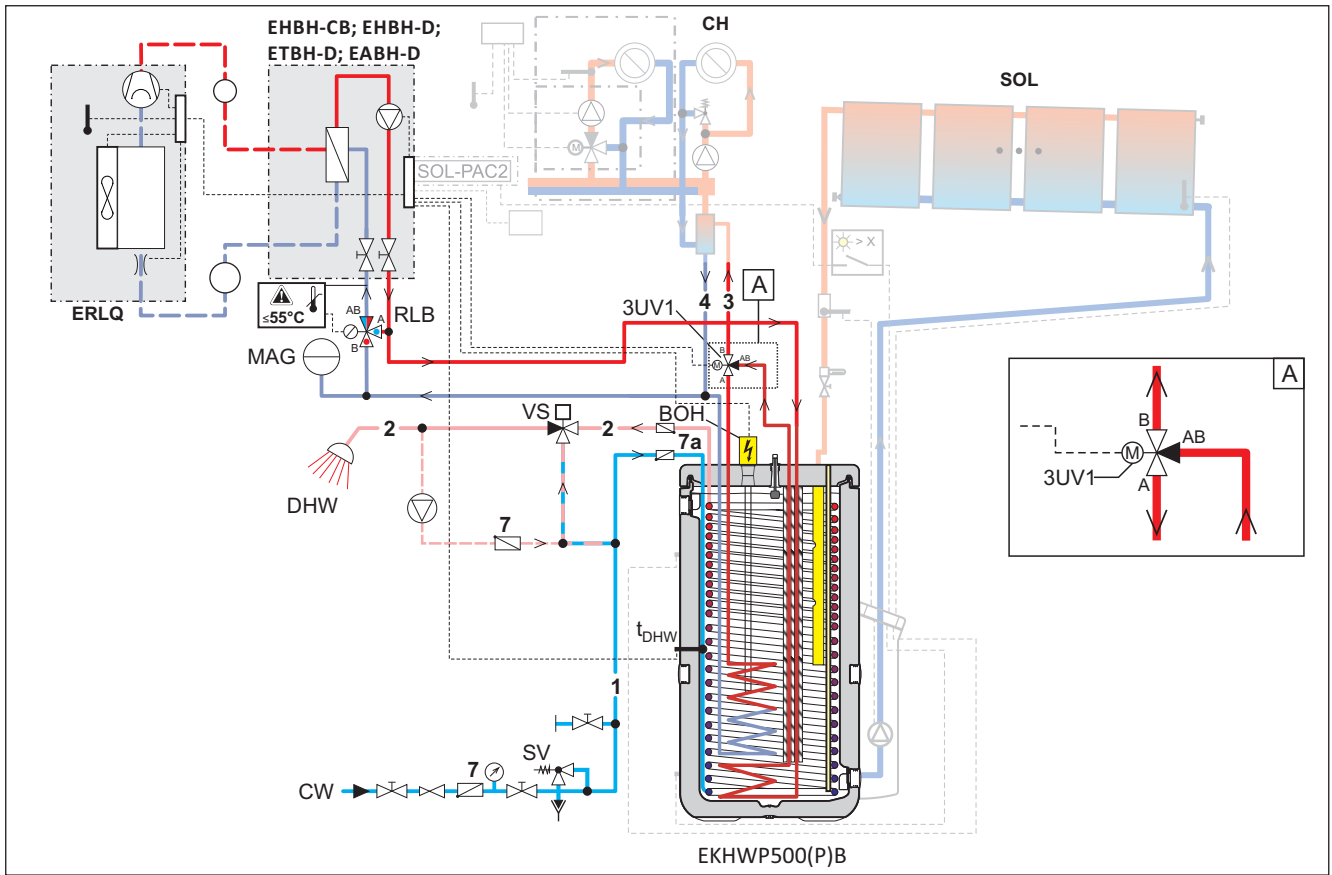

EHBH-CB; EHBH-D; ETBH-D; EABH-D + EKEPRHLT5H



	EN	DE	NL	IT	ES	FR
1	Cold water flow	Kaltwasserleitung	Koudwater-distributienet	Rete di distribuzione dell'acqua fredda	Red de distribución de agua fría	Réseau de distribution de l'eau froide
2	Hot water flow	Warmwasserleitung	Warmwater-distributienet	Rete di distribuzione dell'acqua calda	Red de distribución de agua caliente	Réseau de distribution d'eau chaude
3	Heating flow	Heizung Vorlauf	Verwarming aanvoer	Mandata riscaldamento	Impulsión calefacción	Départ chauffage
3UV1	3-way-switch-valve	3-Wege Umschaltventil	3-wegs omschakelklep	Valvoolaa 3 vie	Válvula de conmutación de 3 vías	Soupape d'inversion à 3 voies
4	Heating return	Heizung Rücklauf	Verwarming terugloop	Ritorno riscaldamento	Retorno calefacción	Retour chauffage
7	Check valve	Rückschlagklappe, Rückflussverhinderer	Terugslagklep, voorkomt terugstroming	Valvola di non ritorno a farfalle, valvola antiritorno	Clapeta antirretorno, inhibidor de reflujo	Clapet anti-retour
7a	Non return valve	Zirkulationsbremsen SKB (Zubehör)	Circulatieremmen	Valvole di ritegno	Válvulas de retención	Clapets anti-thermosiphon
9	Gas pipe (refrigerant)	Gasleitung (Kältemittel)	Gasleiding (koelmiddel)	Tubatura del gas (refrigerante)	Línea de gas (refrigerante)	Conduite de gaz (fluide frigorigène)
10	Fluid pipe (refrigerant)	Flüssigkeitsleitung (Kältemittel)	Vloeistofleiding (koelmiddel)	Tubatura del liquido (refrigerante)	Línea de líquido (refrigerante)	Conduite de liquide (fluide frigorigène)
BOH	Booster Heater	Booster Heater	Booster Heater	Booster Heater	Booster Heater	Booster Heater
C	Refrigerant compressor	Kompressor, Kältemittelverdichter	Koelmiddelcompressor	Compressore refrigerante	Compresor del agente refrigerante	Compresseur de réfrigérant
CH	Central heating	Heizungsnetz	Verwarming	Riscaldamento	Calefacción	Chauffage
CW	Cold Water	Kaltwasser	Koud tapwater	Acqua fredda	Agua fría	Eau froide
DHW	Domestic hot water	Warmwasser	Warmwater	Acqua calda	Agua caliente sanitaria	Eau chaude
E	Expansion valve	Expansionsventil	Expansieklep	Valvola di espansione	Válvula de expansión	Eau chaude
MAG	Diaphragm expansion vessel	Membran-ausdehnungsgefäß	Membraan-expansievat	Vso di espansione a membrana	Depósito de expansión de membrana	Vase d'expansion à membrane
P <sub>HP</sub>	Circulation pump CH	Heizungsumwälz-pumpe	Circulatiepomp verwarming	Pompa di circolazione riscaldamento	Bomba de circulación de la calefacción	Pompe de recirculation de chaleur
PWT	Panel heat exchanger (condenser)	Platten-wärmetauscher (Kondensator)	Plaatwarmtewisselaar (condensator)	Scambiatore di calore a piastre condensatore	Intercambiador de calor de placa (condensador)	Échangeur de chaleur à plaques (condensateur)
RLB	Return temperature limiter	Rücklauf-temperaturbegrenzer	Temperatuurbegrenzer retourleiding	Limitatore temperatura di ritorno	Limitador de temperatura de retorno	Limiteur de température de retour
SOL	Solar system	Solarsystem	Zonne-energiesysteem	Sistema solare	Sistema solar	Système solaire
SV	Safety overpressure valve	Sicherheits-Überdruckventil	Veiligheids-overdrukklep	Valvola di sicurezza contro sovrappressioni	Válvula de sobrepresión de seguridad	Vanne de surpression de sécurité
t <sub>AU</sub>	Exterior temperature sensor	Aussentemperatur-fühler	Buitentemperatuur-sensor	Sonda di temperatura esterna	Sensor de temperatura exterior	Sonde de température extérieure
t <sub>DHW</sub>	Storage tank temperature sensor	Speichertemperatur-fühler (Wärmeerzeuger)	Opslagtemperatuur-sensor (warmteopwekker)	Sonda di temperatura del bollitore	Sensor de temperatura de acumulador	Sonde de température de l'accumulateur
V	Fan (vaporiser)	Ventilator, Verdampfer	Ventilator (verdampfer)	Ventilatore (Evaporatore)	Ventilador (vaporizador)	Ventilateur (évaporateur)
VS	Burns guard VTA 32	Verbrühschutz (z. B. VTA 32)	Verbrandings-beveiliging VT A32	Miscelatore termostatico VTA32	Protección contra la escaldadura VTA32	Protection contre l'échaudure VTA32

Daikin Altherma ST

<b>EKHWP 500(P)B</b>	Hot water storage tank (500 l)	Warmwasser-speicher (500 l)	Warmwaterboiler (500 l)	Bollitore ad accumulo (500 l)	Acumulador de ACS (500 l)	Réservoir d'eau (500 l)
----------------------	--------------------------------	-----------------------------	-------------------------	-------------------------------	---------------------------	-------------------------

<b>ERLQ</b>	Daikin Altherma outdoor unit
-------------	------------------------------

	Daikin Altherma indoor unit
--	-----------------------------

<b>EHBH-CB</b>	Daikin Altherma R W
----------------	---------------------

<b>EHBH-D</b>	Daikin Altherma 3 R W
---------------	-----------------------

<b>ETBH-D</b>	Daikin Altherma 3 H HT W
---------------	--------------------------

<b>EABH-D</b>	Daikin Altherma 3 H W
---------------	-----------------------



Technical data / Technische Daten / Technische gegevens / Dati tecnici / Datos técnicos / Caractéristiques Techniques

Switch valve / Umschaltventil / Omschakelkleb / Valvola selettice / Válvula de conmutación / Vanne d'inversion

Operating voltage / Betriebsspannung / Bedrijfsspanning / Tensione d'esercizio / Tensión de servicio / Tension de fonctionnement	230 V / 50 Hz
Maximum power input / Maximale Leistungsaufnahme / Maximale vermogensopname / Potenza assorbita massima / Absorción de máxima / Puissance absorbée maximum	4,3 W
Protection type / Schutzart / Beschermingklasse / Grado di protezione / Grado de protección / Type de protection	IP 40
Turnaround time / Umschaltzeit / Omschakeltijd / Tempo di commutazione / Tiempo de conmutación / Temps d'inversion	6s
KVS-coefficient / KVS-Wert / KVS-coëfficiënt / KVS-Coefficiente / KVS-coeficiente / KVS-valeur	7,7

Storage tank sensor / Speicherfühler / Opslagtank sensor / Sensore accumulato / Sonda ACS / Sonde ballon

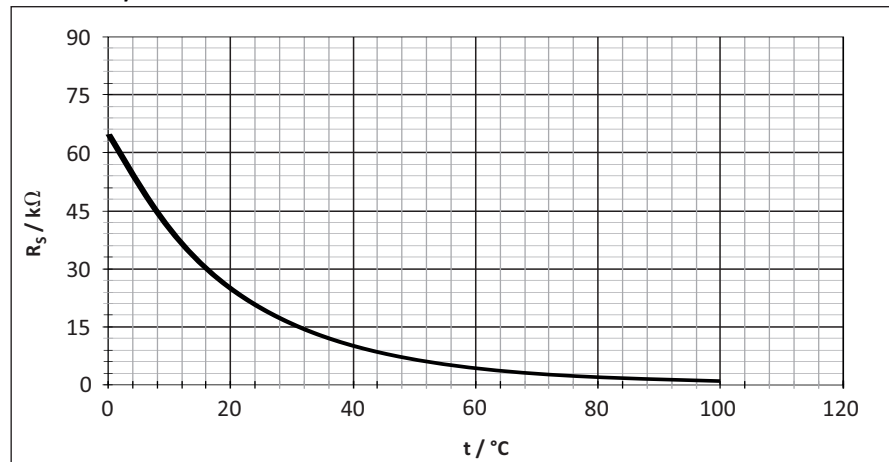

Resistance characteristics /  
Widerstandskennlinie /  
Weerstandskarakteristiek /  
Linea caratteristica /  
Curva característica /  
Caractéristiques de résistance

EHBH-CB; EHBH-D; ETBH-D; EABH-D + EKEPRHLT5H