

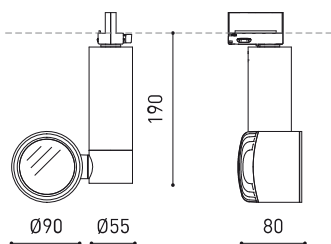

## DIMENSIONS



## ACCESSOIRES



HIGH CHROMATIC LED

ANTI-GLARE HONEYCOMB  
LOUVERELLIPTICAL REFRACTOR | BEAM  
MIXER DIFFUSER

TRACK 3L OPTIONS

## TROPHÉES



Nom	ZEN TUBE 3 FLOOD 42° 3000K NT
Référence	A2842331NT
Couleur	Noir Texturé
RAL	9005
Catégorie	TRACKLIGHTS

## PRODUIT

Type	LED
Flux lumineux brut	3190 lm
Température de couleur	3000 K - Autres K, veuillez consulter
Stabilité chromatique	MacAdam Step 2
Indice de reproduction chromatique	CRI > 90
Puissance	23 W
Courant	700 mA
Efficacité	139 lm/W
Durée de vie de la LED	L80B10 > 60.000h

## SOURCE DE LUMIÈRE

Efficacité lumineuse	90%
Angle du faisceau lumineux	42°

## LUMINAIRE | DONNÉS PHOTOMÉTRIQUES

Driver	Inclus
Valeurs de puissance du système	27,06 W
Tension	220V/240V
Fréquence	50/60 Hz
Variation d'intensité	Non Dim
Classe d'isolation électrique	<input type="checkbox"/>

## LUMINAIRE | DONNÉS ÉLECTRIQUES

Étanchéité	IP20
Contrôle sans fil	Veuillez consulter
Angle de basculement	270°
Angle de rotation	355°
Type de rail	Track 3L+N
Poids	1000 g
Poids avec emballage	1223,6 g
Dimensions de l'emballage	288,5 x 188,5 x 126 mm
Unités par emballage	1
Matériaux	Aluminium / Verre Transparent

## D'AUTRES DONNÉES



DIAGRAMME POLAIRE



DIAGRAMME CONIQUE



POUR PRÉSENTATION COMMERCIALE DU PRODUIT

Vivid Model Colour Temperature	2700K	3000K	3500K	4000K	Light Pink
📖 Reading			•	•	
🥬 Fruits & Vegetables		•	•		
🍞 Bakery	•				
👤 Retail		•	•		
💄 Cosmetics			•	•	
🥩 Meat					•
🐟 Fish				•	
🐠 Seafood				•	•

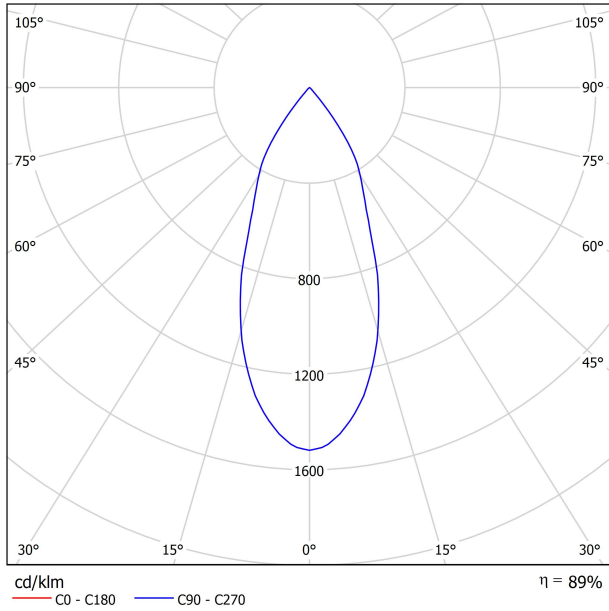
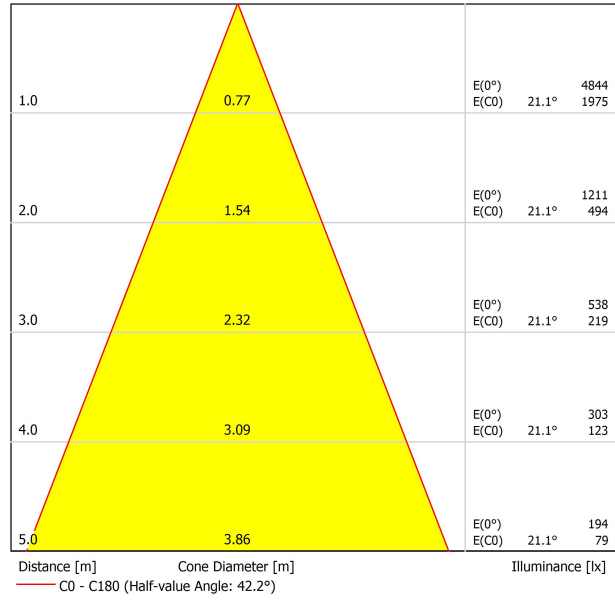

Arkoslight vous offre sur certains de ses produits la possibilité de les équiper d'un LED spécial, qui a été conçu pour une illumination orientée à la promotion visuelle de biens ou produits à des fins commerciales.

Il s'agit d'un LED de haute chromaticité permettant de mettre en évidence les tons qui favorisent une perception psychologique positive de l'objet illuminé.

Cette source de lumière LED spéciale vous offre une palette de couleurs plus attractive et intense, et plus vaste que celle d'un LED conventionnel. Ceci est possible grâce à la configuration du LED qui inclue un "paramètre spécial de saturation", lequel réussit à ce que les couleurs et la texture des objets apparaissent de manière plus attractive dans le spectre de lumière visible. Pour ce faire, le diode correspondant est sélectionné en fonction de chaque cas, et il en est de même pour son revêtement spécifique en phosphore.



	PRODUCT
Model	Anti-glare Honeycomb Louver
Reference	07020200
Category	Accessories

N'EST PAS VENDU SÉPARÉMENT.



Accessoire composé d'une grille en nid d'abeille pour réduire l'éblouissement et l'incidence directe des rayons dans la vision.



	PRODUCT
Model	Elliptical Refractor
Reference	07000800
Category	Accessories

N'EST PAS VENDU SÉPARÉMENT.

Lentille qui reformule le faisceau lumineux pour obtenir une forme elliptique par le biais de la réfraction de la lumière dans son verre optique.



	<b>PRODUCT</b>
<b>Model</b>	Beam Mixer Diffuser
<b>Reference</b>	08050200
<b>Category</b>	Accessories

N'EST PAS VENDU SÉPARÉMENT.

Le Diffuseur homogénéisateur de faisceau lumineux s'utilise pour atténuer les distorsions de l'émission de lumières provoquées par les lentilles paraboliques, Fresnel ou collimateurs TIR, sans allonger de manière significative le faisceau.

Son design exclusif permet une excellente homogénéisation en champs lointains et un mélange chromatique d'une luminosité axiale remarquable. Comparé avec un diffuseur traditionnel, ce diffuseur maintient une plus haute intensité lumineuse au centre du faisceau (CBPC) et diminue l'indésirable effet "champs de lumière" dans les angles plus amples.

## TRACK 3L+N SURFACE & SUSPENDED

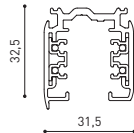

TRACK 3L 1m	A282-01-00-   B   N
TRACK 3L 2m	A282-02-00-   B   N
TRACK 3L 3m	A282-03-00-   B   N



## TRACK 3L+N FLUSH MOUNTING\*

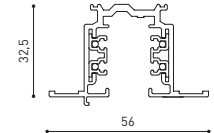

TRACK 3L FLUSH 1m	A282-11-00-   B   N
TRACK 3L FLUSH 2m	A282-12-00-   B   N
TRACK 3L FLUSH 3m	A282-13-00-   B   N



## WEIGHT BEAR CAPACITY

Distancia de fijación y capacidad de carga.  
Distancia fijación recomendada l- 1000 mm.

Fastening distance and loading capacity.  
Recommended fastening distance l- 1000 mm.

Distance de fixation et capacité de charge.  
Distance de fixation recommandée l- 1000 mm.

Distanza di installazione e capacità di carico.  
Distanza consigliata di fissazione l- 1000 mm.

Befestigungsabstand und Belastbarkeit.  
Empfohlener Abstand l- 1000 mm.

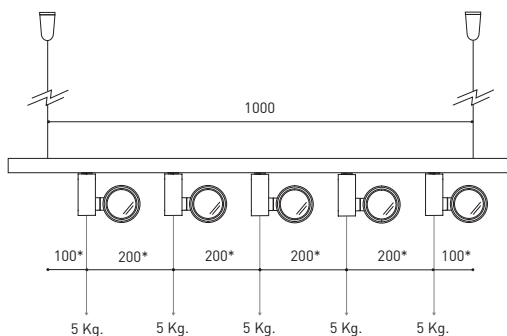

\*minimum distance (mm.)

## ACCESSORIES

FIT MODEL: ACCESSORIES ONLY IN BLACK FINISH  
SIX MODEL: ACCESSORIES NOT AVAILABLE

### TRACKLIGHT Surface Adapter

0000-55-43- | W |

0000-55-39- | N |



### TRACKLIGHT Recessed Adapter

0000-55-44- | W |

0000-55-40- | N |



COLOUR | B □ RAL 9016 | N ■ RAL 9005 |

## SURFACE & SUSPENDED

## FLUSH MOUNTING

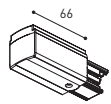

POLARITY GROOVE



### TRACK 3L Live-End Connector

A282-00-01- | B | N |

A282-00-02- | B | N |

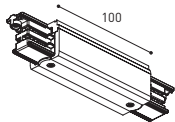

### TRACK 3L Central Connector

A282-00-03- | B | N |



### TRACK 3L Ceiling Kit

A219-21-06- | B | N |

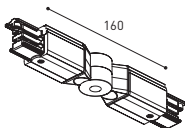

### TRACK 3L Universal Angle

A282-00-15- | B | N |

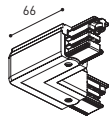

### TRACK 3L 90° Angle

A282-00-06- | B | N |

A282-00-07- | B | N |

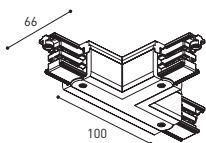

### TRACK 3L T Joint

A282-00-16- | B | N |

A282-00-17- | B | N |

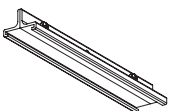

### TRACK 3L Mechanical Joint

A219-21-11- | B | N |



### TRACK 3L Suspension Kit

A219-21-10- | B | N |

At least 2 units needed

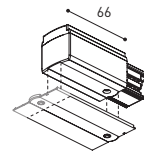

POLARITY GROOVE



### TRACK 3L Live-End Connector

A282-00-01- | B | N |

A282-00-02- | B | N |

### TRACK 3L FLUSH Cover Plate

A282-10-19- | B | N |

Mandatory for installation

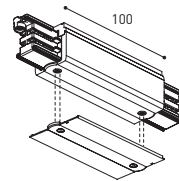

### TRACK 3L Central Connector

A282-00-03- | B | N |

### TRACK 3L FLUSH Cover Plate

A282-10-19- | B | N |

Mandatory for installation



### TRACK 3L FLUSH Ceiling Kit

A219-22-06- | B |

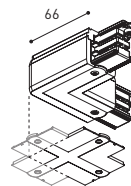

### TRACK 3L 90° Angle

A282-00-06- | B | N |

A282-00-07- | B | N |



### TRACK 3L FLUSH Corner Cover Plate

A282-10-20- | B | N |

Mandatory for installation

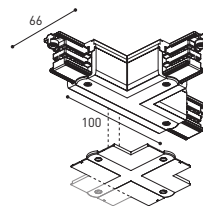

### TRACK 3L T Joint

A282-00-16- | B | N |

A282-00-17- | B | N |



### TRACK 3L FLUSH Corner Cover Plate

A282-10-20- | B | N |

Mandatory for installation

## SURFACE & SUSP. / FLUSH MOUNTING

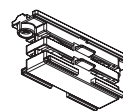

### TRACK Contact Joint

A282-00-04- | B | N |



### TRACK End

A219-20-02- | B | N |



### TRACK Clamp Kit for M6 ROD

A219-21-21- | B |

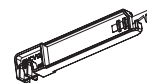

### TRACK Bending Tool

A282-00-00

For tracks its length has been modified

COLOUR | B □ RAL 9016 | N ■ RAL 9005 |



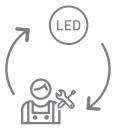

Fuente de luz (LED) reemplazable por un profesional autorizado

Replaceable (LED only) light source by an authorized professional.

Source lumineuse (LED) remplaçable par un professionnel agréé

Sorgente luminosa (LED) sostituibile da parte di un professionista autorizzato

Austauschbare (LED) Lichtquelle durch einen autorisierten Fachmann



Equipo de control reemplazable por un profesional autorizado

Replaceable control gear by an authorized professional

Dispositif de commande remplaçable par un professionnel agréé

Alimentatore sostituibile da parte di un professionista autorizzato

Auswechselbares Betriebsgerät durch autorisierten Fachmann

INSTRUCCIONES PARA EL FINAL DE VIDA Y LA ELIMINACIÓN LOS COMPONENTES  
 INSTRUCTIONS ON END-OF-LIFE AND COMPONENT DISPOSAL  
 INSTRUCTIONS POUR LA GESTION DES COMPOSANTS EN FIN DE VIE ET LEUR MISE AU REBUT  
 ISTRUZIONI PER IL FINE VITA E LO SMALTIMENTO DEI COMPONENTI  
 ANWEISUNGEN ZUR ENTSORGUNG DER LEUCHTENKOMPONENTEN



Interrumpir la alimentación del aparato  
 Cut the power supply to the luminaire  
 Couper l'alimentation du luminaire  
 Interrompere l'alimentazione dell'apparecchio  
 Stromversorgung der Leuchte unterbrechen



Quitar la(s) fuente(s) de luz para el desecho  
 Remove light source(s) for disposal  
 Retirer la (les) source(s) lumineuse(s) pour l'élimination  
 Rimuovere la/le sorgente/e di luce per lo smaltimento  
 Lichtquelle(n) zur Entsorgung entfernen

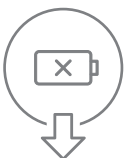

Quitar la batería para el desecho  
 Remove the battery for decommissioning  
 Retirer la batterie pour sa mise au rebut  
 Rimuovere la batteria per la dismissione  
 Die Batterie ordnungsgemäß entsorgen



Quitar el equipo de control para el desecho  
 Remove control gear for disposal  
 Retirer le dispositif de commande pour l'élimination  
 Rimuovere l'alimentatore per lo smaltimento  
 Betriebsgerät zur Entsorgung ausbauen



Enviar los materiales a un centro de recogida RAEE  
 Send the materials to a WEEE collection centre  
 Envoyer les matériaux dans une déchetterie DEEE  
 Inviare i materiali ad un centro di raccolta RAEE  
 Die Materialien in einem WEEE-Zentrum entsorgen

