



SFS60-HNBT2K02

SFS/SFM60

MOTOR FEEDBACK SYSTEMS ROTARY HIPERFACE®

SICK
Sensor Intelligence.



Illustration may differ



Ordering information

| Type | Part no. |
|----------------|----------|
| SFS60-HNBT2K02 | 1054384 |

Other models and accessories → www.sick.com/SFS_SFM60

Detailed technical data

Performance

| | |
|---|---|
| Sine/cosine periods per revolution | 1,024 |
| Number of the absolute ascertainable revolutions | 1 |
| Total number of steps | 32,768 |
| Measuring step | 0.3 " For interpolation of the sine/cosine signals with, e. g., 12 bits |
| Integral non-linearity | Typ. $\pm 45 "$, Error limits for evaluating sine/cosine period, without mechanical tension of the stator coupling |
| Differential non-linearity | $\pm 7 "$, Non-linearity within a sine/cosine period |
| Operating speed | $\leq 6,000 \text{ min}^{-1}$, up to which the absolute position can be reliably produced |
| Available memory area | 1,792 Byte |
| System accuracy | $\pm 52 "$ |

Interfaces

| | |
|--|--|
| Type of code for the absolute value | Binary |
| Code sequence | Rising, For clockwise shaft rotation, looking in direction "A" (see dimensional drawing) |
| Communication interface | HIPERFACE® |

Electrical data

| | |
|---|--|
| Connection type | Male connector, M12, 8-pin, radial |
| Supply voltage | 7 V DC ... 12 V DC |
| Recommended supply voltage | 8 V DC |
| Current consumption | < 80 mA (without load) |
| Output frequency for sine/cosine signals | $\leq 200 \text{ kHz}$ |
| MTTF: mean time to dangerous failure | 230 years (EN ISO 13849) ¹⁾ |

¹⁾ This product is a standard product and does not constitute a safety component as defined in the Machinery Directive. Calculation based on nominal load of components, average ambient temperature 60 °C, frequency of use 8760 h/a. All electronic failures are considered hazardous. For more information, see document no. 8015532.

Mechanical data

| | |
|---------------------------------------|---|
| Shaft version | Through hollow shaft |
| Shaft diameter | 1/2" |
| Shaft material | Stainless steel |
| Flange material | Zinc diecast |
| Housing material | Aluminum die cast |
| Flange type / stator coupling | Stator coupling |
| Dimensions | See dimensional drawing |
| Weight | ≤ 0.25 kg |
| Moment of inertia of the rotor | 40 gcm ² |
| Operating speed | ≤ 9,000 min ⁻¹ ¹⁾ |
| Angular acceleration | ≤ 500,000 rad/s ² |
| Operating torque | 0.6 Ncm (+20 °C) |
| Start up torque | + 0.8 Ncm (+20 °C) |
| Permissible movement static | ± 0.3 mm, ± 0.5 mm radial, axial |
| Permissible movement dynamic | ± 0.1 mm radial ± 0.2 mm axial |
| Life of ball bearings | 3.6 x 10 ⁹ revolutions |

¹⁾ Allow for self-heating of 3.3 K per 1,000 rpm when designing the operating temperature range.

Ambient data

| | |
|--|--|
| Operating temperature range | -40 °C ... +115 °C |
| Storage temperature range | -40 °C ... +115 °C, without package |
| Relative humidity/condensation | 90 %, Condensation not permitted |
| Resistance to shocks | 100 g, 6 ms (according to EN 60068-2-27) |
| Frequency range of resistance to vibrations | 20 g, 10 Hz ... 2,000 Hz (EN 60068-2-6) |
| EMC | According to EN 61000-6-2 and EN 61000-6-3 ¹⁾ |
| Enclosure rating | IP65, with mating connector inserted (IEC 60529) |

¹⁾ The EMC according to the standards quoted is achieved when the motor feedback system is mounted in an electrically conductive housing, which is connected to the central earthing point of the motor controller via a cable screen. The GND-(0 V) connection of the supply voltage is also grounded here. If other shielding concepts are used, users must perform their own tests.

Classifications

| | |
|---------------------|----------|
| eCl@ss 5.0 | 27270590 |
| eCl@ss 5.1.4 | 27270590 |
| eCl@ss 6.0 | 27270590 |
| eCl@ss 6.2 | 27270590 |
| eCl@ss 7.0 | 27270590 |
| eCl@ss 8.0 | 27270590 |
| eCl@ss 8.1 | 27270590 |
| eCl@ss 9.0 | 27270590 |
| eCl@ss 10.0 | 27273805 |
| eCl@ss 11.0 | 27273901 |

| | |
|-----------------------|----------|
| eCl@ss 12.0 | 27273901 |
| ETIM 5.0 | EC001486 |
| ETIM 6.0 | EC001486 |
| ETIM 7.0 | EC001486 |
| ETIM 8.0 | EC001486 |
| UNSPSC 16.0901 | 41112113 |

Dimensional drawing (Dimensions in mm (inch))

Through hollow shaft, male connector - standard system

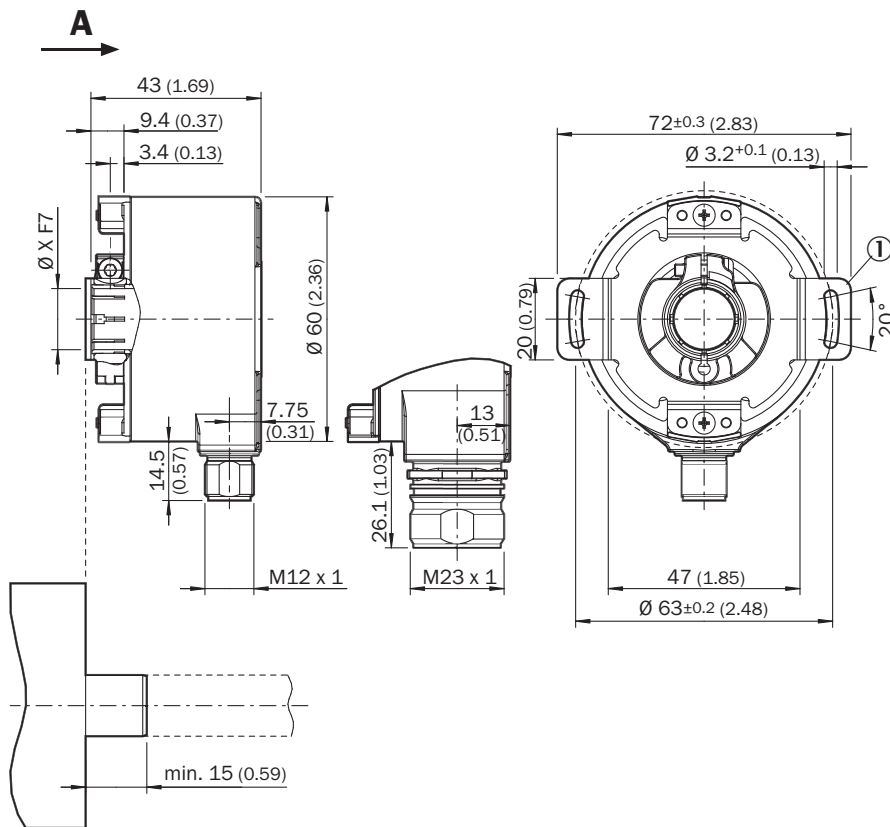

General tolerances according to DIN ISO 2768-mk

① Dimensional drawing of the stator coupling may differ depending on the variant. Please also refer to the dimensional drawing of the stator coupling.

BEF-DS02DFS/VFS

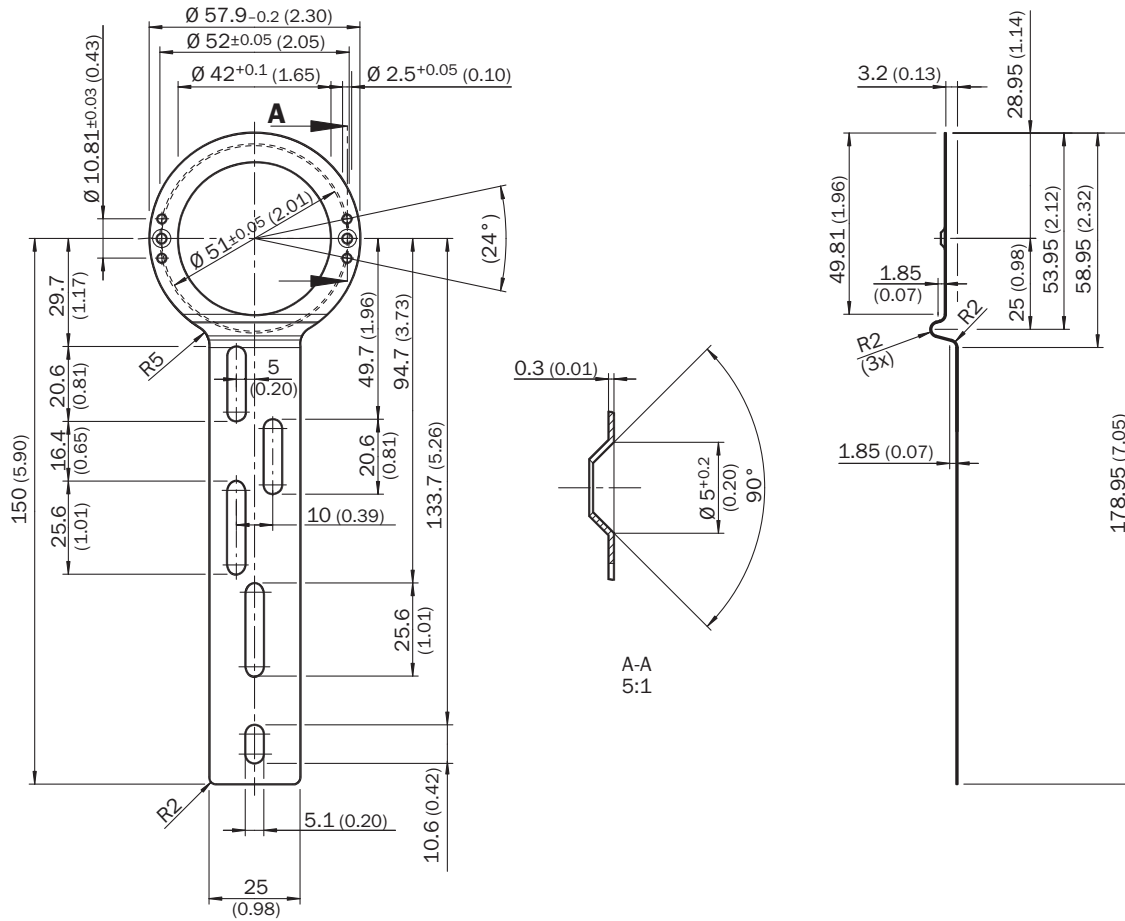

PIN assignment

View of the M12 male connector plug-in face

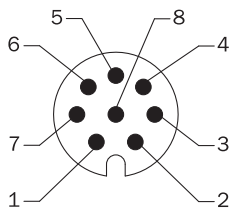

| PIN | Signal | Explanation |
|-----|----------------|--------------------------|
| 1 | REFSIN | Process data channel |
| 2 | + SIN | Process data channel |
| 3 | REFCOS | Process data channel |
| 4 | + COS | Process data channel |
| 5 | Data + | Parameter channel RS 485 |
| 6 | Data - | Parameter channel RS 485 |
| 7 | GND | Ground connection |
| 8 | U _S | Supply voltage |

| PIN | Signal | Explanation |
|---------|--------|-------------------------------------|
| Housing | Screen | Screen connected to encoder housing |

Diagrams



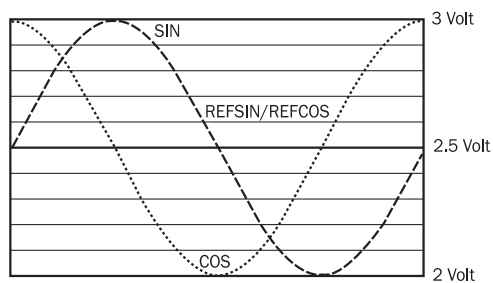



Signal specification of the process channel



Signal diagram for clockwise rotation of the shaft looking in direction "A" (see dimensional drawing) 1 period = $360^\circ : 1024$

Recommended accessories

Other models and accessories → www.sick.com/SFS_SFM60

| | Brief description | Type | Part no. |
|---|---|-----------------|----------|
| Programming and configuration tools | | | |
|  | SVip® LAN programming tool for all motor feedback systems | PGT-11-S LAN | 1057324 |
| Flanges | | | |
|  | One-sided stator coupling, slot, slot radius 33 mm to 48.5 mm, slot width 5.1 mm | BEF-DS01DFS/VFS | 2047428 |
|  | One-sided stator coupling, slot, slot radius 32.25 mm to 141.75 mm, slot width 5.1 mm | BEF-DS02DFS/VFS | 2047430 |
|  | One-sided stator coupling, slot, slot radius 33 mm to 211.9 mm, slot width 5.1 mm | BEF-DS03DFS/VFS | 2047431 |
|  | Stator coupling, 16.5 mm high | BEF-DS05XFX | 2057423 |
|  | Stator coupling with hole circle diameter Ø72 mm | BEF-DS07XFX | 2059368 |

SICK AT A GLANCE

SICK is one of the leading manufacturers of intelligent sensors and sensor solutions for industrial applications. A unique range of products and services creates the perfect basis for controlling processes securely and efficiently, protecting individuals from accidents and preventing damage to the environment.

We have extensive experience in a wide range of industries and understand their processes and requirements. With intelligent sensors, we can deliver exactly what our customers need. In application centers in Europe, Asia and North America, system solutions are tested and optimized in accordance with customer specifications. All this makes us a reliable supplier and development partner.

Comprehensive services complete our offering: SICK LifeTime Services provide support throughout the machine life cycle and ensure safety and productivity.

For us, that is “Sensor Intelligence.”

WORLDWIDE PRESENCE:

Contacts and other locations –www.sick.com