

# Metal flat enclosures MF

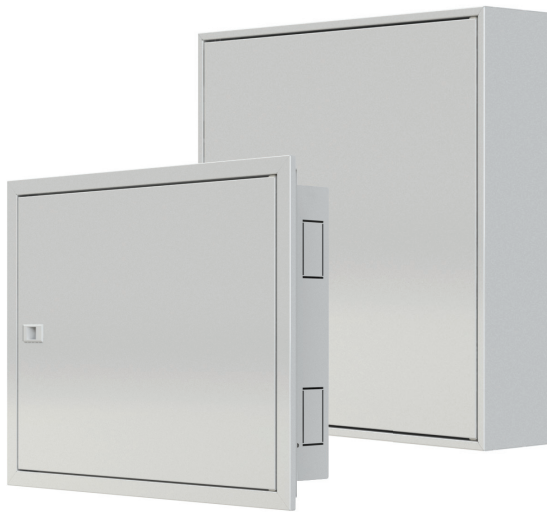

- Metal (sheet-steel) flat enclosures MF
- Tested according to EN 62208
- Variants for surface and flush mounting
- Versions with 24 and 33 modules per a row, 2 up to 6 rows
- Degree of protection IP40
- Protection against mechanical impact IK07
- White colour or upon request
- Mounting depth lower than 147 mm, suitable also for narrow walls

Sheet-steel enclosures MFF/MFS are suitable for various applications mainly in domestic and commercial installations. Their flat design and technical solution allow easy mounting onto wall or into relatively narrow walls, including plasterboard ones.

Removable adjustable doorframe allows to avoid possible damage during mounting and especially to compensate wall surface imperfections, including slight rotation. Besides blind white door there are also offered variants with glazed window. The door opening direction can be easily changed thanks to applied system of hinges.

On the enclosures there are prepared pre-cut openings for conductors or cable grommets. The adjusting before connecting can thus be done very quickly. All variants are equipped with a removable mounting frame with DIN rails. Whole installation part is covered with self-earthed sheet-steel front plates.

An important part of enclosures MF is a wide range of accessories for their customisation. There are offered mounting plates, space separators, front plates, cable grommets, cable fixing rail, key-locks and others.

## Type Key

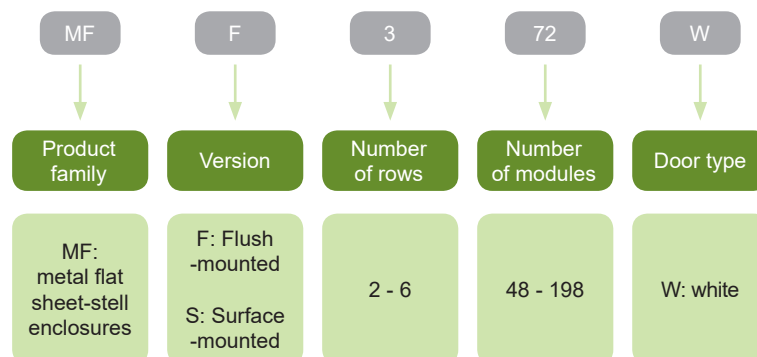

## Certification marks



# Metal flat enclosures MF

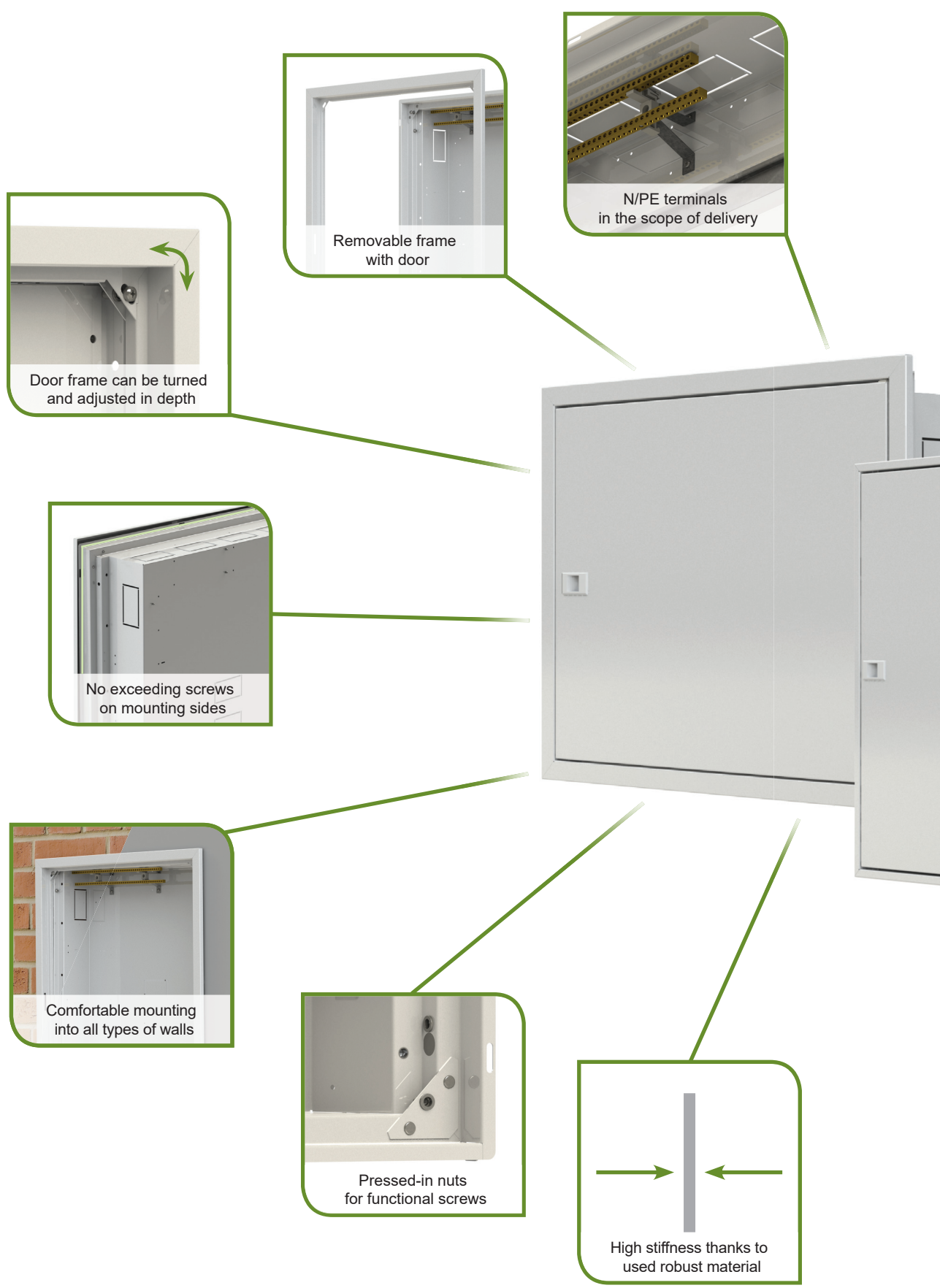

# Metal flat enclosures MF

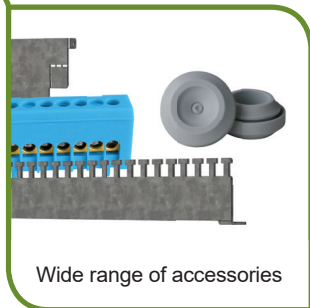
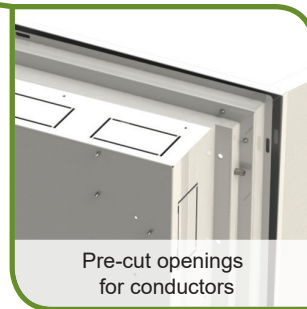
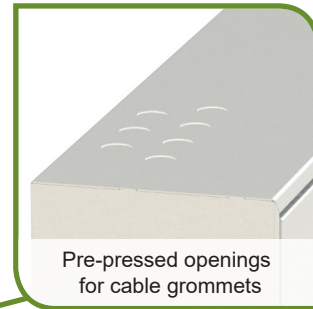
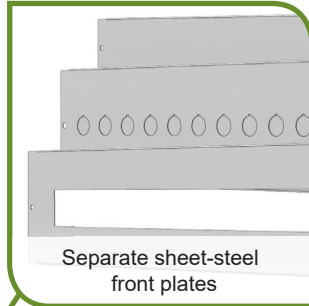

# Metal flat enclosures MF

## Flush mounted versions, sheet-steel door

- Flush mounted
- 24 or 33 modules per a row
- 2 up to 6 rows
- White door colour
- Scope of delivery: enclosure, metal frame with door, mounting frame with device DIN rails, N + PE terminals, front plates with device cutout, grounding cable for door connection, mounting material and instruction sheet



Modules per a row	Number of rows	Total modules	N+PE terminals	Article No.	Type	Packing
24	2	48	2x 2+43	105559	MFF2 48W	1
24	3	72	2x 2+43	105560	MFF3 72W	1
24	4	96	2x 2+43	105561	MFF4 96W	1
24	5	120	2x 2+43	105562	MFF5 120W	1
24	6	144	2x 2+43	105563	MFF6 144W	1
33	2	66	2x 2+43	105564	MFF2 66W	1
33	3	99	2x 2+43	105565	MFF3 99W	1
33	4	132	2x 2+43	105566	MFF4 132W	1
33	5	165	2x 2+43	105567	MFF5 165W	1
33	6	198	2x 2+43	105568	MFF6 198W	1

## Surface mounted versions, sheet-steel door

- Surface mounted
- 24 or 33 modules per a row
- 2 up to 6 rows
- White door colour
- Scope of delivery: enclosure, metal frame with door, mounting frame with device DIN rails, N + PE terminals (except E version), front plates with device cutout, grounding cable for door connection, mounting material and instruction sheet



Modules per a row	Number of rows	Total modules	N+PE terminals	Article No.	Type	Packing
24	2	48	2x 2+43	105886	MFS2 48W	1
24	3	72	2x 2+43	105887	MFS3 72W	1
24	4	96	2x 2+43	105888	MFS4 96W	1
24	5	120	2x 2+43	105889	MFS5 120W	1
24	6	144	2x 2+43	105890	MFS6 144W	1
33	2	66	2x 2+43	105891	MFS2 66W	1
33	3	99	2x 2+43	105892	MFS3 99W	1
33	4	132	2x 2+43	105893	MFS4 132W	1
33	5	165	2x 2+43	105894	MFS5 165W	1
33	6	198	2x 2+43	105895	MFS6 198W	1



# Metal flat enclosures MF

## Spare door

- Spare door with plastic lock for flush mounted enclosures
- 24 or 33 modules per a row
- 2 up to 6 rows
- White coloured sheet-steel parts of door
- Packed separately
- Door hinges are not included



Modules per a row	Number of rows	Total modules	Article No.	Type	Packing
24	2	48	105926	MFF DR2 48W	1
24	3	72	105927	MFF DR3 72W	1
24	4	96	105928	MFF DR4 96W	1
24	5	120	105929	MFF DR5 120W	1
24	6	144	105930	MFF DR6 144W	1
33	2	66	105931	MFF DR2 66W	1
33	3	99	105932	MFF DR3 99W	1
33	4	132	105933	MFF DR4 132W	1
33	5	165	105934	MFF DR5 165W	1
33	6	198	105935	MFF DR6 198W	1

## Spare door

- Spare door with plastic lock for surface mounted enclosures
- 24 or 33 modules per a row
- 2 up to 6 rows
- White coloured sheet-steel part of door
- Packed separately
- Door hinges are not included



Modules per a row	Number of rows	Total modules	Article No.	Type	Packing
24	2	48	105946	MFS DR2 48W	1
24	3	72	105947	MFS DR3 72W	1
24	4	96	105948	MFS DR4 96W	1
24	5	120	105949	MFS DR5 120W	1
24	6	144	105950	MFS DR6 144W	1
33	2	66	105951	MFS DR2 66W	1
33	3	99	105952	MFS DR3 99W	1
33	4	132	105953	MFS DR4 132W	1
33	5	165	105954	MFS DR5 165W	1
33	6	198	105955	MFS DR6 198W	1

## Spare door hinges

- Spare door hinges set (1 set necessary for 1 door)
- Common for flush and surface mounted enclosure's door
- Packed separately
- In the scope of delivery: plastic holders, metal hinges



Description	Article No.	Type	Packing
Spare door hinges	106021	MF SDH	1 set

# Metal flat enclosures MF

## Metal front plates

- Various types and sizes of spare front plates for covering of internal space in enclosures according to used devices and needs
- Common for flush and surface mounted enclosures
- 24 or 33 modules per a row variants
- White coloured sheet-steel
- Packed separately
- Mounting screws in the scope of delivery

### Metal front plates with device cutout 45 mm



Description	Modules per a row	Height	Article No.	Type	Packing
Standard plate	24	141 mm	105966	MF FP 1 24	1
Wide outer plate	24	212 mm	105968	MF FP 1+ 24	1
Standard plate	33	141 mm	105967	MF FP 1 33	1
Wide outer plate	33	212 mm	105969	MF FP 1+ 33	1

### Blind metal front plates



Description	Modules per a row	Height	Article No.	Type	Packing
Narrow outer plate	24	71 mm	105974	MF FPB 0+ 24	1
Standard plate	24	141 mm	105970	MF FPB 1 24	1
Wide outer plate	24	212 mm	105972	MF FPB 1+ 24	1
Narrow outer plate	33	71 mm	105975	MF FPB 0+ 33	1
Standard plate	33	141 mm	105971	MF FPB 1 33	1
Wide outer plate	33	212 mm	105973	MF FPB 1+ 33	1

### Metal front plates with opening for 22 mm panel devices

- Pre-cut design, blind front plate as the state of delivery
- Number of device cutouts 12 for 24 MU width, 16 for 33 MU width version
- Suitable for 22 mm panel mounted devices Ex9IL, Ex9P1, Ex9PB



Description	Modules per a row	Height	Article No.	Type	Packing
Narrow outer plate	24	71 mm	105978	MF FPPD 0+ 24	1
Standard plate	24	141 mm	105976	MF FPPD 1 24	1
Narrow outer plate	33	71 mm	105979	MF FPPD 0+ 33	1
Standard plate	33	141 mm	105977	MF FPPD 1 33	1

## Universal mounting plates

- Universal mounting plates for mounting of arbitrary devices of appropriate dimensions with screws
- Can be fitted also by means of pressed screws in order not to overlap outer dimensions of the enclosure
- Common for flush and surface mounted enclosures
- 24 or 33 modules per a row variants
- Galvanized sheet-sheet
- Packed separately
- Mounting material in the scope of delivery

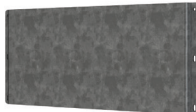

Description	Modules per a row	Height	Article No.	Type	Packing
Universal mounting plate	24	80 mm	105980	MF UMP 80 24	1
Universal mounting plate	24	160 mm	105982	MF UMP 160 24	1
Universal mounting plate	33	80 mm	105981	MF UMP 80 33	1
Universal mounting plate	33	160 mm	105983	MF UMP 160 33	1

# Metal flat enclosures MF

## Metal front plates for MCCBs Ex9M

- Pre-cut front plate for MCCB of Ex9M line mounted in vertical and horizontal position
- Common for flush and surface mounted enclosures
- 24 or 33 modules per row variants
- Front plate height 141 mm
- White coloured sheet-steel
- Packed separately
- Mounting material in the scope of delivery



Description	Modules per row	Article No.	Type	Packing
For vertically mounted Ex9M1 3P	24	105986	MF FP M1V 3P 24	1
For vertically mounted Ex9M1 4P	24	105988	MF FP M1V 4P 24	1
For vertically mounted Ex9M2 3P	24	105990	MF FP M2V 3P 24	1
For vertically mounted Ex9M2 4P	24	105992	MF FP M2V 4P 24	1
For horizontally mounted Ex9M1 3P	24	105987	MF FP M1H 3P 24	1
For horizontally mounted Ex9M1 4P	24	105989	MF FP M1H 4P 24	1
For horizontally mounted Ex9M2 3P	24	105991	MF FP M2H 3P 24	1
For vertically mounted Ex9M1 3P	33	105994	MF FP M1V 3P 33	1
For vertically mounted Ex9M1 4P	33	105996	MF FP M1V 4P 33	1
For vertically mounted Ex9M2 3P	33	105998	MF FP M2V 3P 33	1
For vertically mounted Ex9M2 4P	33	106000	MF FP M2V 4P 33	1
For horizontally mounted Ex9M1 3P	33	105995	MF FP M1H 3P 33	1
For horizontally mounted Ex9M1 4P	33	105997	MF FP M1H 4P 33	1
For horizontally mounted Ex9M2 3P	33	105999	MF FP M2H 3P 33	1

## Mounting plates for MCCBs line Ex9M

- Tailored pre-drilled mounting plates for mounting of MCCBs of Ex9M line, frame sizes M1 and M2
- Mounting holes with thread for easy mounting of Ex9M1 and Ex9M2
- In case common mounting depth of the M1 size breaker's front panel is requested, it is necessary to use mounting depth spacers WG 10
- Common for flush and surface mounted enclosures
- 24 or 33 modules per row variants
- Galvanized sheet-steel
- Packed separately
- Mounting material in the scope of delivery

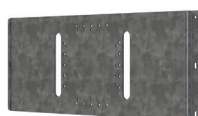

Description	Modules per row	Article No.	Type	Packing
Mounting plate for MCCBs	24	105984	MF MP M12 24	1
Mounting plate for MCCBs	33	105985	MF MP M12 33	1

## Mounting depth spacers for mounting of M1 size MCCB

- Set of mounting depth spacers for compensation of differences in height between frame sizes M1 and M2
- Assure the same position of front panel towards front plate
- Height 10 mm to fit M1 size of MCCBs with front plates MF FP M1



Description	Frame size	Height	Article No.	Type	Packing
Mounting depth spacers	M1	10 mm	106321	WG 10	1 set

# Metal flat enclosures MF

## Horizontal separators

- Horizontal space separators can be used e.g. for separation of electronic and electric part of installation
- Common for flush and surface mounted enclosures
- 24 or 33 modules per a row variants
- Galvanized sheet-sheet
- Packed separately
- Mounting material in the scope of delivery



Description	Modules per a row	Article No.	Type	Packing
Horizontal separator	24	106014	MF HS 24	1
Horizontal separator	33	106015	MF HS 33	1

## Cable fixing rails

- Metal rail suitable for cable fixing in the enclosure
- Common for flush and surface mounted enclosures
- 24 or 33 modules per row variants
- Galvanized sheet-sheet
- Packed separately
- Mounting material in the scope of delivery



Description	Modules per a row	Article No.	Type	Packing
Cable fixing rail	24	106019	MF CFR24	1
Cable fixing rail	33	106020	MF CFR33	1

## Mounting holders

- Set of metal straps for fixing and easier mounting of flush mounted enclosures into the walls
- Can be used as mounting holders when installing into brick walls or for fixing into construction of plaster boards, when the wall supports are not located directly at the edge of the enclosure
- Packed separately
- Four pieces in the scope of delivery



Description	Article No.	Type	Packing
Set of mounting holders for flush mounted enclosures	106022	MFF MH	1 set

## Spare mounting material

- Spare mounting material for MF line enclosures
- Scope of delivery: grounding cable for door with pads and nuts, screws



Description	Article No.	Type	Packing
Spare mounting material for flush mounted enclosures	106017	MFF SMM	1 set
Spare mounting material for surface mounted enclosures	106016	MFS SMM	1 set

# Metal flat enclosures MF

## Set for mounting of MF DLK lock-keys

- Set (two tailored metal cover plates) for mounting of lock-key to the plastic lock cutout in enclosure's door
- Suitable MF DLK lock-key to be ordered separately
- Common for flush and surface mounted enclosures
- White coloured sheet-steel
- Packed separately without lock-key



Description	Article No.	Type	Packing
Set for mounting of MF DLK lock-key	106018	MF LMS	1 set

## Lock-keys

- Suitable sets of lock-keys for mounting set MF LMS
- Various types of inserts
- Housing diameter 28 mm, height 18 mm
- Cam length 35 mm
- Packed separately without MF LMS
- In the scope of delivery: housing, insert, flat external seal, nut, cam, screw

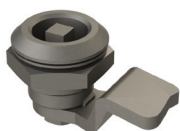

Insert shape		Article No.	Type	Packing
square socket, 6 mm		106826	MF DLK SQ6	1 set
square pin, 6 mm		106863	MF DLK SP6	1 set
double bit, 3 mm pin		106825	MF DLK DB3	1 set
double bit, 5 mm pin		106828	MF DLK DB5	1 set
slotted 2x4mm		106829	MF DLK S24	1 set
Czech crescent		106827	MF DLK CZ	1 set
Daimler-Benz		106830	MF DLK D	1 set

# Metal flat enclosures MF

## Spare DIN rails

- Spare single DIN rail
- Common for flush and surface mounted enclosures
- 24 or 33 modules per row variants
- Galvanized sheet-sheet
- Packed separately



Description	Modules per row	Article No.	Type	Packing
Spare single DIN rail	24	106002	MF DIN24	1
Spare single DIN rail	33	106003	MF DIN33	1

## Spare mounting frames

- Spare mounting frame (DIN rails with holder)
- Common for flush and surface mounted enclosures
- 24 or 33 modules per row variants
- Galvanized sheet-sheet
- Packed separately



Description	Modules per a row	Number of rows	Article No.	Type	Packing
Spare mounting frame	24	2	106004	MF SMF2 48	1
Spare mounting frame	24	3	106005	MF SMF3 72	1
Spare mounting frame	24	4	106006	MF SMF4 96	1
Spare mounting frame	24	5	106007	MF SMF5 120	1
Spare mounting frame	24	6	106008	MF SMF6 144	1
Spare mounting frame	33	2	106009	MF SMF2 66	1
Spare mounting frame	33	3	106010	MF SMF3 99	1
Spare mounting frame	33	4	106011	MF SMF4 132	1
Spare mounting frame	33	5	106012	MF SMF5 165	1
Spare mounting frame	33	6	106013	MF SMF6 198	1

## Additional N/PE terminals

- Rated current up to 63 A
- Packed separately

### Horizontal terminal bar holders



Description	Article No.	Type	Packing
Horizontal terminal bar holders	106823	MF TBH	1 set

### Terminal bars



Description	Terminals	Article No.	Type	Packing
N/PE terminal bar	2x25 + 45x16 mm <sup>2</sup>	106824	MF TB45+2	1



# Metal flat enclosures MF

## Covered neutral and grounding terminal bars

- Rated current up to 63 A
- Rated operational voltage 690 V AC
- All side finger-safe
- One-side closed conductor notch
- Plastic DIN-rail clip
- For wires up to 16 mm<sup>2</sup>



Terminals	Terminal capacity	Colour	Article No.	Type	Packing
7	up to 16 mm <sup>2</sup>	blue	103850	TBB 7x16	1/10
7	up to 16 mm <sup>2</sup>	green	103851	TBG 7x16	1/10
15	up to 16 mm <sup>2</sup>	blue	103852	TBB 15x16	1/10
15	up to 16 mm <sup>2</sup>	green	103853	TBG 15x16	1/10

## Uncovered neutral and grounding terminal bars

- Rated current up to 63 A
- Rated operational voltage 690 V AC
- Plastic DIN-rail clip
- For wires up to 10 mm<sup>2</sup>



Terminals	Terminal capacity	Colour	Article No.	Type	Packing
7	10 mm <sup>2</sup>	blue	103854	TBB 7x10	1/10
7	10 mm <sup>2</sup>	green	103855	TBG 7x10	1/10
12	10 mm <sup>2</sup>	blue	103856	TBB 12x10	1/10
12	10 mm <sup>2</sup>	green	103857	TBG 12x10	1/10

## Terminal bars up to 63 A with steel DIN rail clip

- Rated current up to 63 A
- Rated operational voltage 690 V AC
- Steel-sheet DIN-rail clip, self-earthed
- For wires up to 10 mm<sup>2</sup>

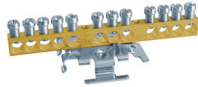

Terminals	Terminal capacity	Article No.	Type	Packing
7	10 mm <sup>2</sup>	103858	TB 7x10	1/10
12	10 mm <sup>2</sup>	103859	TB 12x10	1/10

# Metal flat enclosures MF

## Plastic cover for empty place

- Plastic cover for unused 45 mm device cutouts
- Total width 224 mm, can be shortened
- Segmented as 1x 15 mm, 22 x 1/2 module width, 1x 15 mm
- White colour plastic
- Packed separately



Description	Article No.	Type	Packing
Plastic cover for unused 45 mm device cutout	101574	B CC45	1/500

## Plastic documentation pocket

- Self-adhesive pocket for documentation
- Suitable for A4 paper size documents
- Two versions according to number of pages
- PVC material
- Packed separately

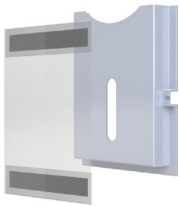

Description	Size	Article No.	Type	Packing
Self-adhesive documentation pocket	A4	106831	MF PDP A4	1
Self-adhesive documentation pocket, slim	A4	106832	MF PDP A4S	1

## Cable grommets

- Cable grommets suitable for cutouts prepared on the topside of surface mounted enclosures
- Top panels of MFS enclosures are pre-cut for 16 mm diameter grommets
- Used material allows to use various diameter of the conductors (up to 50 mm<sup>2</sup>)
- Packed separately



Description	Diameter	Article No.	Type	Packing
Cable grommet for MFS enclosures	16 mm	106860	CGQS M16	1
Cable grommet	20 mm	106208	CGQS M20	1
Cable grommet	25 mm	106209	CGQS M25	1
Cable grommet	32 mm	106210	CGQS M32	1

# Metal flat enclosures MF

## Type label

- Pre-printed type label for distribution boards according to EN 61439
- Box texts in EN, CZ, SK, PL, RO, DE, FR, RU, UK, BG, HR, HU, IT, LT, LV, EE language
- Material: Aluminium foil, resistive to chemical cleaners
- Self-adhesive



Description	Article No.	Type	Packing
Empty type label for distribution boards, self-adhesive	107841	MF TL	10

## Special colour on request

- Enclosures MF can be produced in non-standard colours
- Standards RAL codes can be chosen
- Please contact NOARK staff with specification, based on which real possibility will be checked

## Special version on request

- Enclosures MF can be produced in modified design
- Changes must not affect general parameters of the enclosure
- Typical changes - e.g. non-standard dimensions (within the range of smallest and biggest type), different internal configuration, etc.
- Please contact NOARK staff with specification, based on which real possibility will be checked

# Technical Data MF

## Metal (sheet-steel) flat enclosures

### General parameters

Sheet-steel enclosures suitable for various applications mainly in domestic and commercial applications
Variants for surface and flush mounting, usable also for hollow walls including plasterboard ones
Removable adjustable doorframe allows to compensate wall surface imperfections, including slight rotation
Prepared pre-cut openings for conductors or cable grommets
Wide range of accessories

### Electrical parameters

Tested according to	EN 62208
Rated operational voltage $U_e$	400 V AC
Rated frequency	50 Hz
Insulation voltage $U_i$	415 V AC
Degree of protection	IP40 (respect to recommended mounting)
Degree of protection against external mechanical impact	IK07 (versions with sheet-steel door)
Protection class	I
Overvoltage category	IV
Pollution degree	3

### Mechanical parameters

Number of modules (MU) per row	24, 33
Number of rows	2, 3, 4, 5, 6
Mounting	surface and flush-mounting
Mounting depth (MFF)	146.5 mm
Door	white sheet-steel
Door opening	left and right
Door load	1 kg
Door to front plates distance MFF / MFS	49 / 34 mm
Maximum door opening angle	110°
Used metal material - enclosure, door, front plates, separators, etc. - mounting plates	galvanized sheet-steel thickness 1 mm  thickness 2 mm
Painted metal parts colour	powder coated, white, flat, RAL 9003

### N/PE terminals in the scope of delivery

Max. rated current of N/PE terminals	63 A
Suitable material of conductors	Cu
Number of N/PE terminal bars	2
Terminal capacity	2x 25 mm <sup>2</sup> + 43x 16 mm <sup>2</sup>
Width	331 mm

# Technical Data MF

## Metal (sheet-steel) flat enclosures

### Maximum static load

Maximum allowed load of all installed devices and other non-standard parts

<b>MFF2 48W</b>	10,8 kg	<b>MFS2 48W</b>	11 kg
<b>MFF3 72W</b>	15,6 kg	<b>MFS3 72W</b>	16 kg
<b>MFF4 96W</b>	20,2 kg	<b>MFS4 96W</b>	20,8 kg
<b>MFF5 120W</b>	23,4 kg	<b>MFS5 120W</b>	24,3 kg
<b>MFF6 144W</b>	25,9 kg	<b>MFS6 144W</b>	28 kg
<b>MFF2 66W</b>	13,9 kg	<b>MFS2 66W</b>	14,4 kg
<b>MFF3 99W</b>	20 kg	<b>MFS3 99W</b>	20,8 kg
<b>MFF4 132W</b>	25,7 kg	<b>MFS4 132W</b>	26,7 kg
<b>MFF5 165W</b>	29,7 kg	<b>MFS5 165W</b>	32 kg
<b>MFF6 198W</b>	32 kg	<b>MFS6 198W</b>	37 kg

### Power dissipation

Maximum power dissipation of all installed devices at ambient temperature 30 °C

<b>MFF2 48W</b>	69 W	<b>MFS2 48W</b>	76 W
<b>MFF3 72W</b>	82 W	<b>MFS3 72W</b>	90 W
<b>MFF4 96W</b>	95 W	<b>MFS4 96W</b>	105 W
<b>MFF5 120W</b>	109 W	<b>MFS5 120W</b>	117 W
<b>MFF6 144W</b>	123 W	<b>MFS6 144W</b>	130 W
<b>MFF2 66W</b>	78 W	<b>MFS2 66W</b>	88 W
<b>MFF3 99W</b>	102 W	<b>MFS3 99W</b>	110 W
<b>MFF4 132W</b>	120 W	<b>MFS4 132W</b>	128 W
<b>MFF5 165W</b>	135 W	<b>MFS5 165W</b>	141 W
<b>MFF6 198W</b>	144 W	<b>MFS6 198W</b>	156 W

### Weight

Total weight of complete enclosure (including doors, front plates, mounting frame, etc.) without devices

<b>MFF2 48W</b>	10,5 kg	<b>MFS2 48W</b>	10,0 kg
<b>MFF3 72W</b>	13,2 / kg	<b>MFS3 72W</b>	12,7 kg
<b>MFF4 96W</b>	15,9 kg	<b>MFS4 96W</b>	16,8 kg
<b>MFF5 120W</b>	18,5 kg	<b>MFS5 120W</b>	17,8 kg
<b>MFF6 144W</b>	21,1 kg	<b>MFS6 144W</b>	20,5 kg
<b>MFF2 66W</b>	12,6 kg	<b>MFS2 66W</b>	12,2 kg
<b>MFF3 99W</b>	15,7 kg	<b>MFS3 99W</b>	15,3 kg
<b>MFF4 132W</b>	18,8 kg	<b>MFS4 132W</b>	18,5 kg
<b>MFF5 165W</b>	21,9 kg	<b>MFS5 165W</b>	21,8 kg
<b>MFF6 198W</b>	25,1 kg	<b>MFS6 198W</b>	24,9 kg

# Technical Data MF

## Metal (sheet-steel) flat enclosures

### Front plates in the scope of delivery

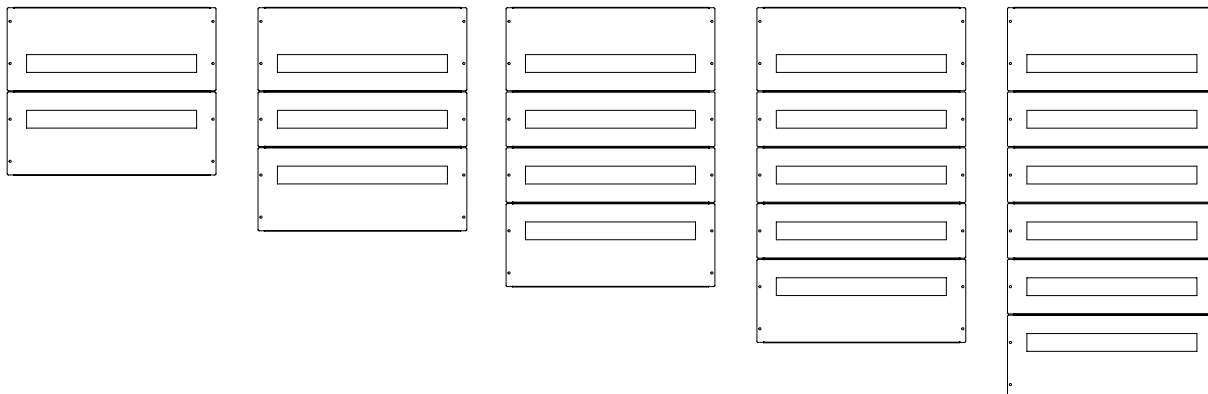

MFF#/MFS#

### Pre-cut openings for conductors or cable grommets - flush-mounted versions

MFF2 48W MFF3 72W MFF4 96W MFF5 120W	2x 47x85 mm (back side, center) + 4x 47x85 mm (top) + 4x 47x85 mm (bottom) + 2x 47x85 mm (left-hand side) + 2x 47x85 mm (right-hand side)
MFF6 144W	2x 47x85 mm (back side, center) + 4x 47x85 mm (top) + 4x 47x85 mm (bottom) + 2x 47x85 mm (left-hand side) + 2x 47x85 mm (right-hand side)
MFF2 66W MFF3 99W MFF4 132W MFF5 165W	2x 47x85 mm (back side, center) + 5x 47x85 mm (top) + 5x 47x85 mm (bottom) + 2x 47x85 mm (left-hand side) + 2x 47x85 mm (right-hand side)
MFF6 198 W	2x 47x85 mm (back side, center) + 5x 47x85 mm (top) + 5x 47x85 mm (bottom) + 3x 47x85 mm (left-hand side) + 3x 47x85 mm (right-hand side)

### Pre-cut openings for conductors or cable grommets - surface-mounted versions

all MFS variants	4x 47x55.6 mm (back side, center) + 4x 47x85 mm (back size, corners) + 14x round Ø16 mm (top)
------------------	---



# Technical Data MF

## Metal (sheet-steel) flat enclosures

### Dimensional drawings - flush-mounted versions

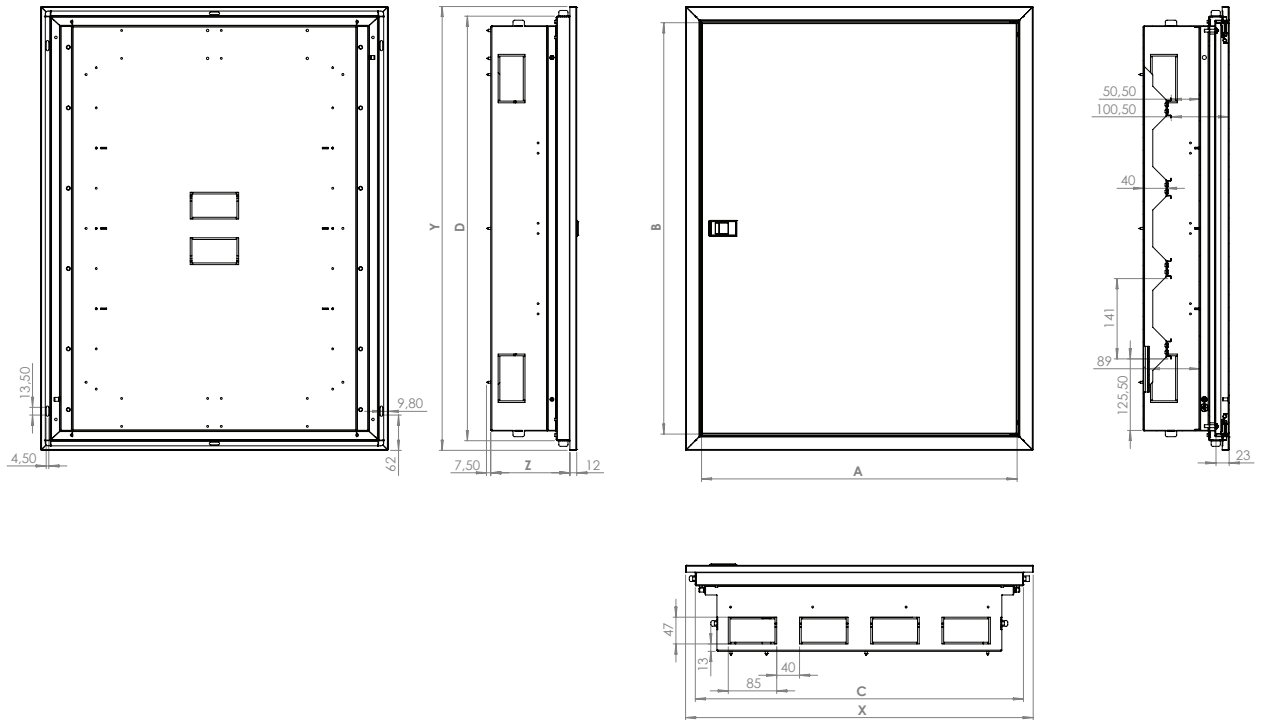

### Dimensions

Type	Dimensions [mm]						
	Width (X)	Height (Y)	Mounting depth (Z)	Door width (A)	Door height (B)	Wall opening width (C)	Wall opening height (D)
MFF2 48W	610,1	497	139	554	440	576	463
MFF3 72W	610,1	638	139	554	581	576	604
MFF4 96W	610,1	779	139	554	722	576	745
MFF5 120W	610,1	920	139	554	863	576	886
MFF6 144W	610,1	1061	139	554	1004	576	1027
MFF2 66W	774,1	497	139	718	440	740	463
MFF3 99W	774,1	638	139	718	581	740	604
MFF4 132W	774,1	779	139	718	722	740	745
MFF5 165W	774,1	920	139	718	863	740	886
MFF6 198W	774,1	1061	139	718	1004	740	1027

# Technical Data MF

## Metal (sheet-steel) flat enclosures

### Dimensional drawings - surface-mounted versions

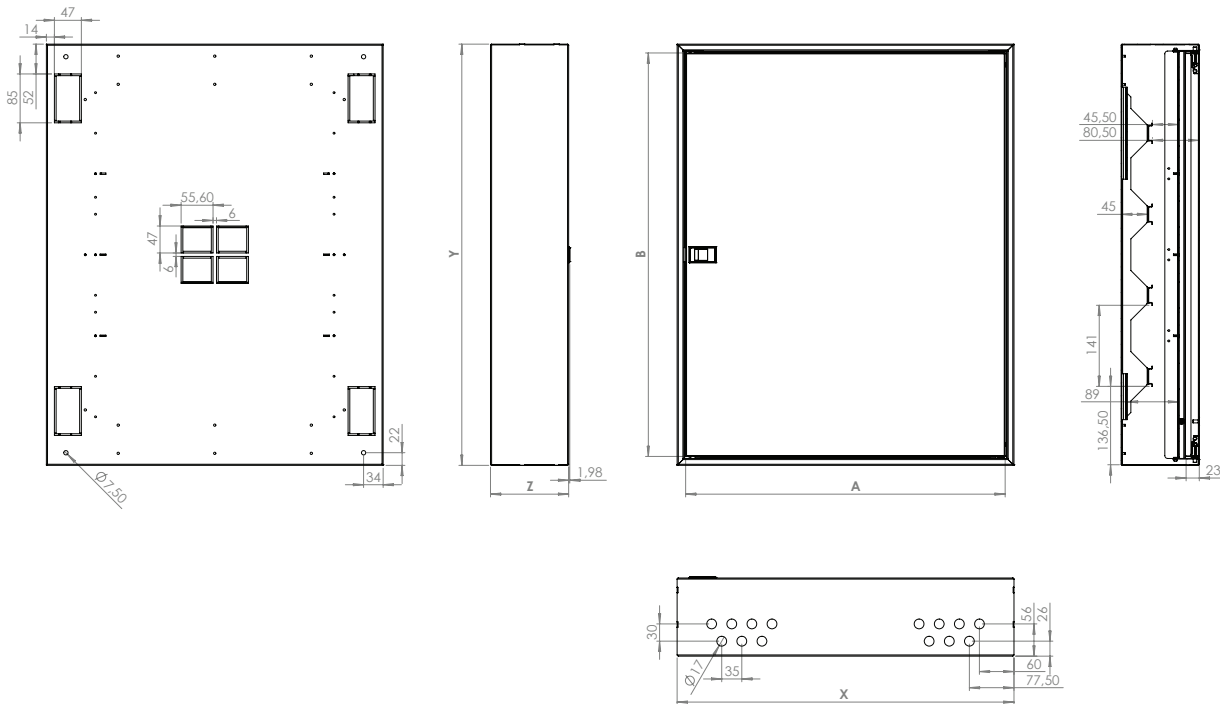

### Dimensions

Type	Dimensions [mm]				
	Width (X)	Height (Y)	Depth (Z)	Door width (A)	Door height (B)
MFS2 48W	586	451	136	556	420
MFS3 72W	586	592	136	556	561
MFS4 96W	586	733	136	556	702
MFS5 120W	586	874	136	556	843
MFS6 144W	586	1115	136	556	984
MFS2 66W	750	451	136	720	420
MFS3 99W	750	592	136	720	561
MFS4 132W	750	733	136	720	702
MFS5 165W	750	874	136	720	843
MFS6 198W	750	1115	136	720	984

# Technical Data MF

## Metal (sheet-steel) flat enclosures - description of technical solution

### Pre-cut openings for conductors

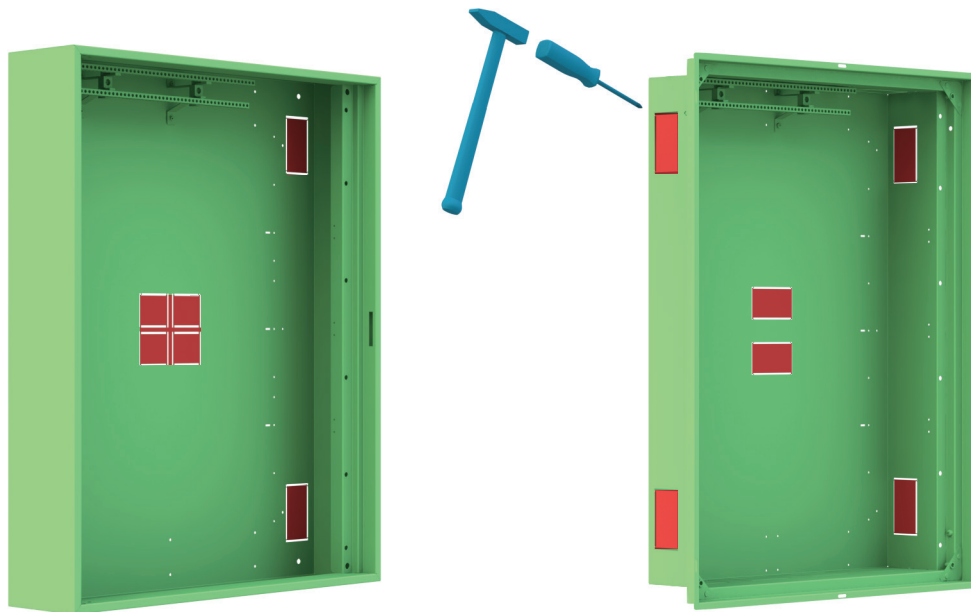

MF enclosures are equipped with pre-cut openings for conductors on the rear side and sides (MFF variants only).

#### Workflow:

1. Select suitable opening for conductors.
2. Using hammer and for example screwdriver cut the metal connecting bridges on the cover of the opening. Alternatively you can cut the bridges with the metal shears.
3. For breaking of the cover use flat pliers.

# Technical Data MF

## Metal (sheet-steel) flat enclosures - description of technical solution

### Prepared openings for cable grommets on MFS versions

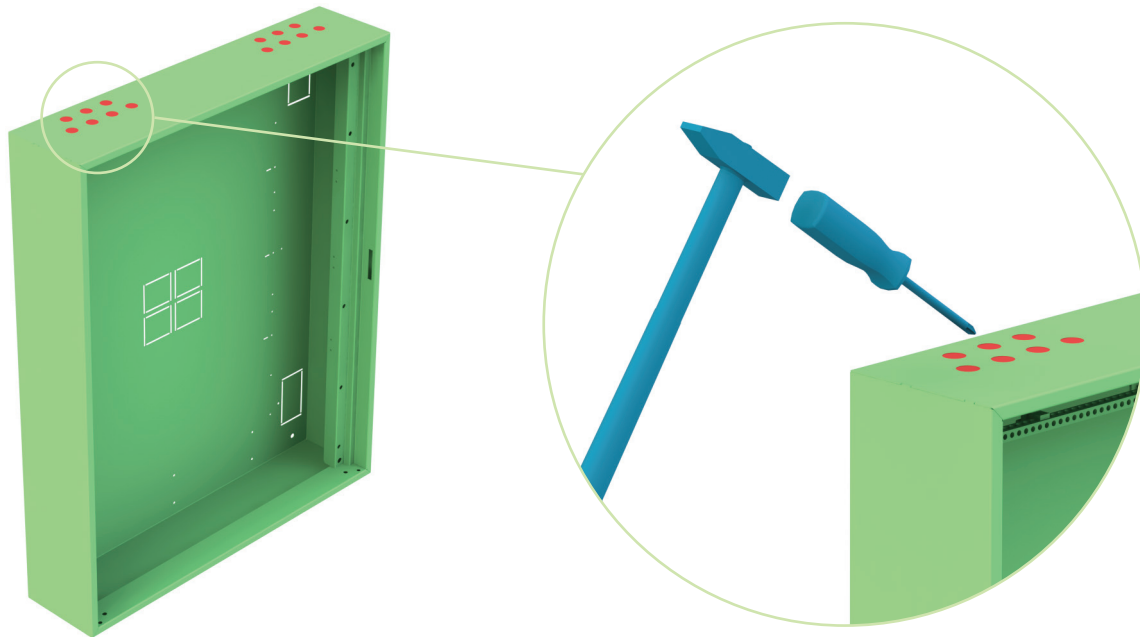

Surface-mounted enclosures MFS have prepared openings for the cable grommets CGQS M16 on the top side. This feature significantly simplifies installation and also reduces the risk of damage of the enclosure when drilling holes. Used technology also limits the size of unpainted surface of the hole.

With the ability to change the direction of the door opening and the position of N/PE terminals it is possible to turn the enclosure so that the cable grommets are located on the top or bottom side.

#### Workflow:

1. Select one prepared opening for the cable grommet.
2. Tapping with the hammer through a suitable tool (screwdriver, center punch) open the prepared hole for the cable grommet. Ensure a firm grip of the tool, not to damage paint outside the opening.

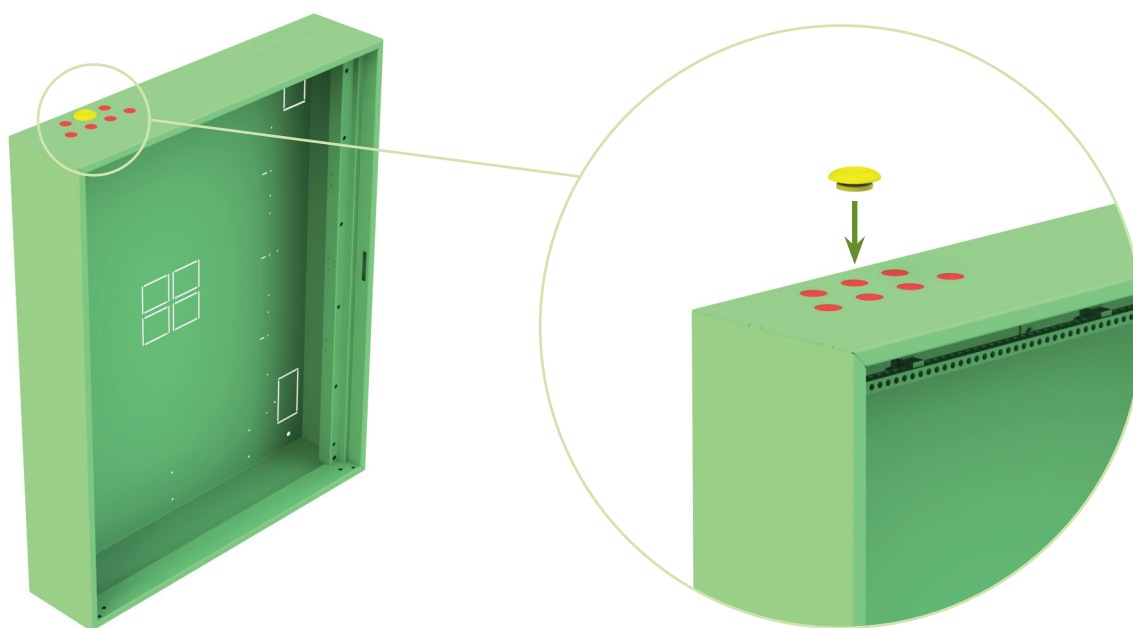

3. Push the cable grommet CGQS M16 into the hole.

# Technical Data MF

## Metal (sheet-steel) flat enclosures - description of technical solution

### Design of screw connections

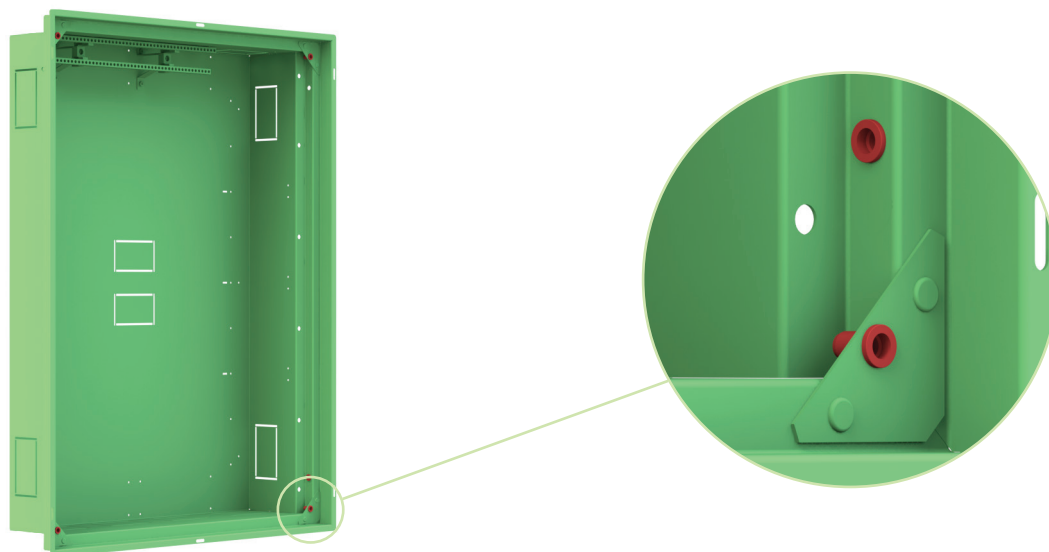

- Positions intended to be fitted with functional screws e.g. for fixing of front plates or grounding cable are equipped with pressed nuts. It improves mounting comfort and also reliability of the connection.
- Mounting points at the rear panel of the surface mounted enclosures MFS are done in version of pressed screws. As a result, there is no overlap of the screws out of the outer profile of the enclosure and thus they do not interfere during mounting onto a wall. Similar mounting way can be chosen also for accessories.

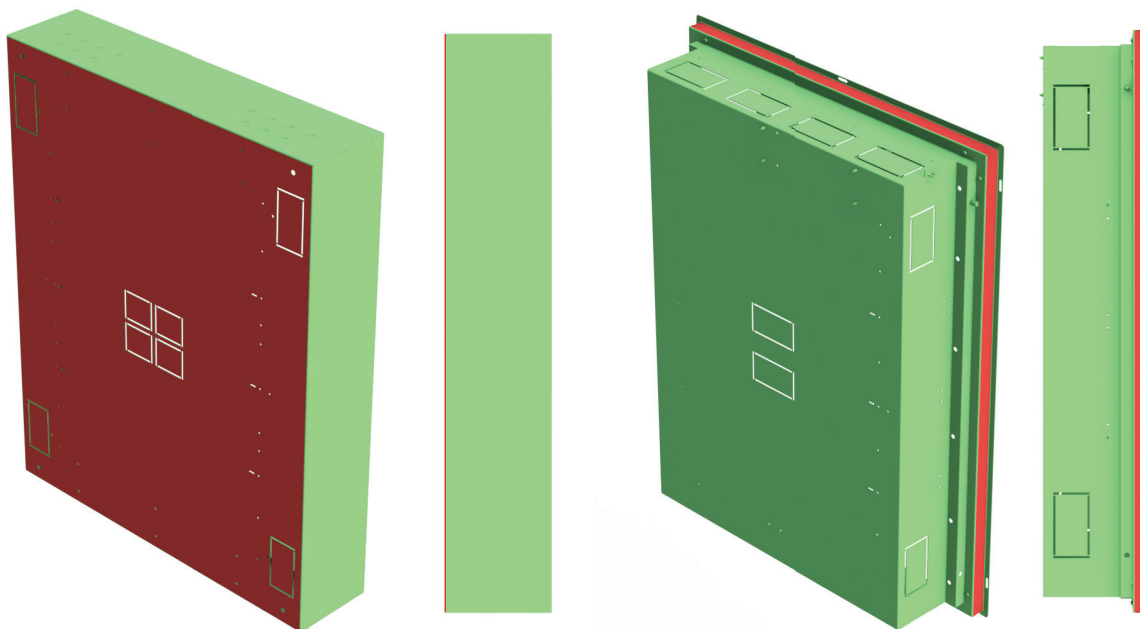

- Neither mounting screws nor pressed nuts in flush mounted enclosures MFF overlap outer profile of the board. Thus, mounting hole in the wall is plain without any additional cut outs for screws. This feature significantly speeds up and simplifies mounting into all types of walls, especially in cases when more accurate pointing is required or possible (such as plasterboard or aerated concrete walls).

# Technical Data MF

## Metal (sheet-steel) flat enclosures - description of technical solution

### Comfortable mounting onto/into all types of walls



Enclosures MF are designed for easy and comfortable mounting onto/into all types of walls without additional accessories. Due to mounting depth as only as 147 mm, the flush-mounted variants are suitable also for hollow walls.

#### Workflow:

1. Place the enclosure on the wall or into the prepared cutout in the wall.
2. If necessary, use for the temporary fixation of the variants MFF to the wall the mounting holders MFF MH.

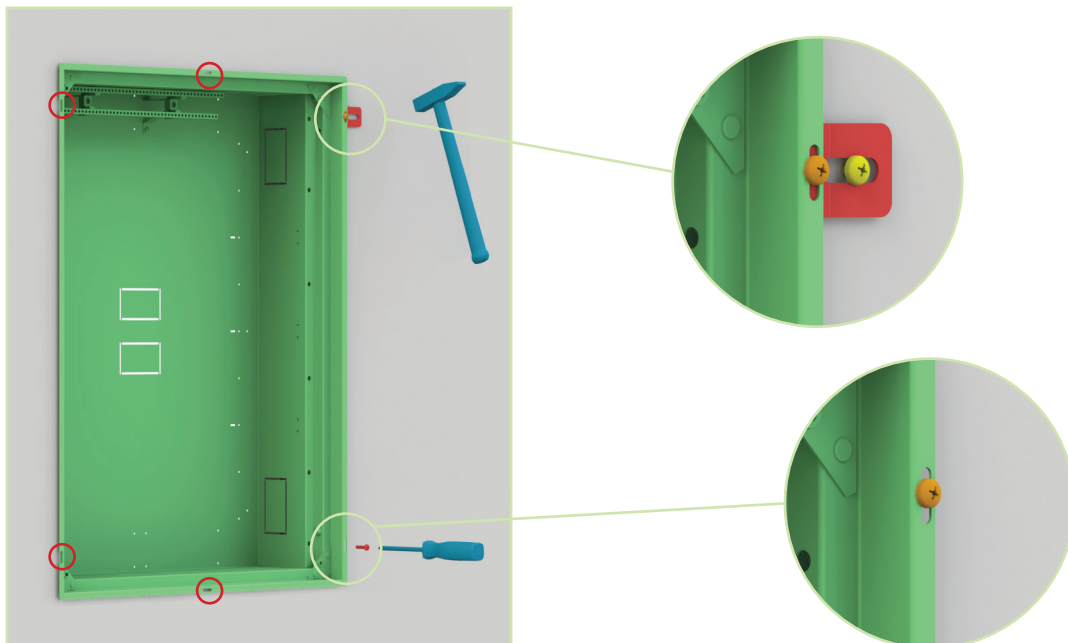

3. In case of mounting of MFF variants into the hollow walls it is possible to use directly the prepared holes in the enclosure frame or you can use the mounting holders MFF MH, if the wall support structure does not lie entirely to the enclosure.
4. Use an appropriate mounting material for fixing of the enclosure to the wall.



# Technical Data MF

## Metal (sheet-steel) flat enclosures - description of technical solution

### Mounting and adjusting of the frame on MFF variants

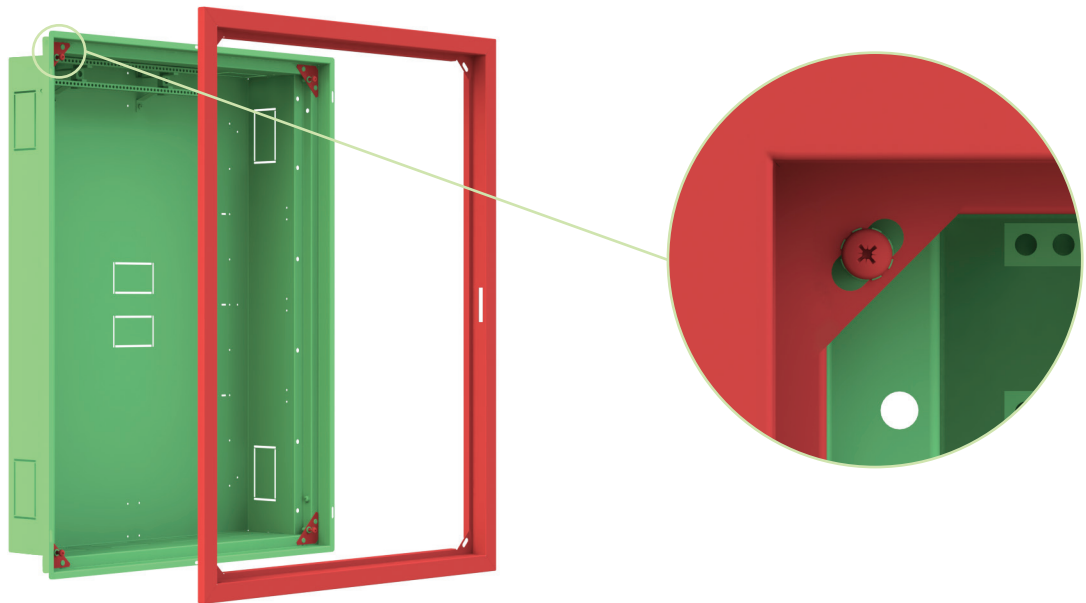

#### Workflow:

1. Place the door frame to the enclosure and fix it in the corners with the attached screws. Do not tighten them.
2. Align the frame into the correct position. The design of enclosures allows slightly adjust the position of the frame in all three axis in case of unaccurate walling and depth correction.

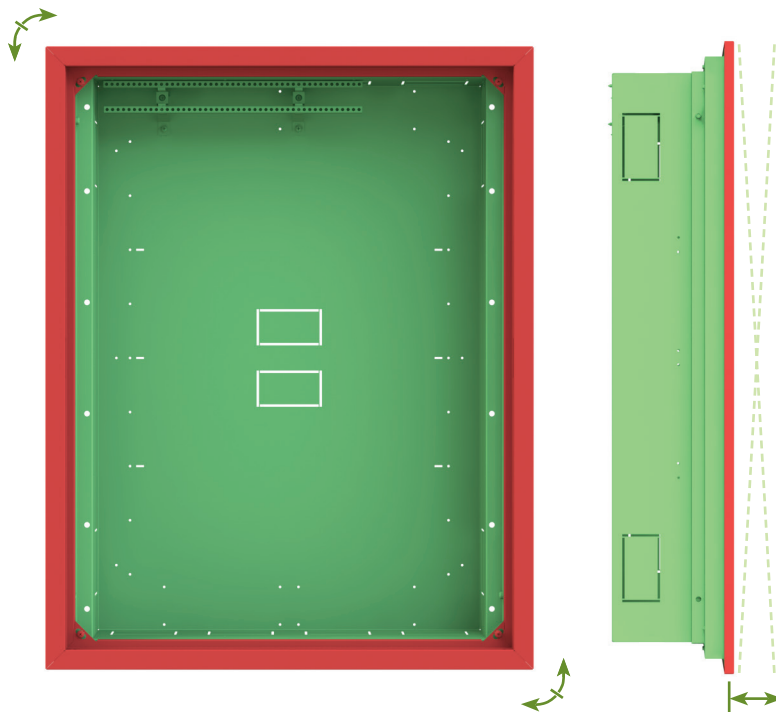

3. Tighten the mounting screws in the corners.

# Technical Data MF

## Metal (sheet-steel) flat enclosures - description of technical solution

### Position of N/PE terminals

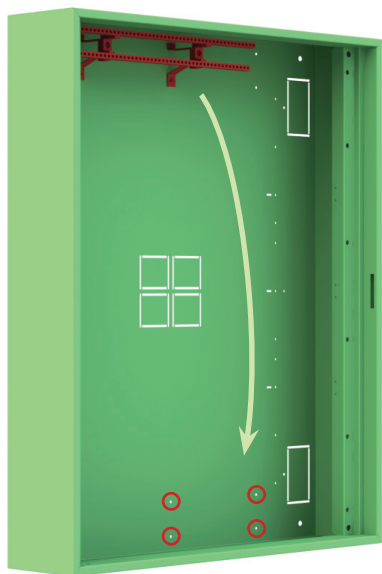

In MF enclosures it is possible to place N/PE terminals to the top or bottom part of the enclosure.

#### Workflow:

1. Remove fixing nuts/screws.
2. Place the terminals onto the designated screws/holes on the other side of the enclosure.
3. Fasten with nuts/screws.

# Technical Data MF

## Metal (sheet-steel) flat enclosures - description of technical solution

### Removing of DIN rail and shortening of mounting frame



In the MF enclosures it is possible to reduce number of DIN rails on the mounting frame. It may be required e.g. when MCCBs or other devices on universal mounting plate are installed. Removing of DIN rail can be done by removing of rivet connection between the rail and the mounting frame or shortening of the entire mounting frame. The mounting frame itself does not prevent installation of mounting plates.

#### Mounting frame shortening workflow:

1. Mark the point where the frame should be shortened. It is necessary to take care that the frame is shortened behind the area where the mounting hole is located so that it can be fastened through it to the enclosure.
2. Loosen the retaining nuts/screws and remove the mounting frame from the enclosure.
3. Shorten the mounting frame where indicated. Shortening can be done by hacksaw or metal shears.
4. Place the shortened mounting frame back into the enclosure to its original position. Fasten it in newly formed end area with screws. In case of surface-mounted versions MFS it is possible to fasten it also from the back side with the countersunk screw with nut to avoid exceeding over the outer surface profile.
5. Fasten with the nuts/screws.

# Technical Data MF

## Metal (sheet-steel) flat enclosures - description of technical solution

### Mounting of Ex9M line MCCB

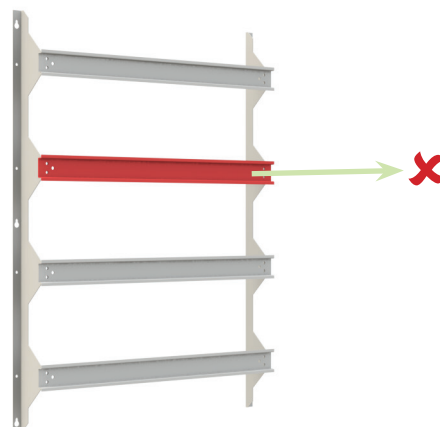

#### Workflow:

1. Place the mounting plate MF MP M to the required position. The plate can be placed in the position of middle front plates. In case of mounting into position of the outer front plates, the right position is given by inner edge of the front plate which should be equal with vertical position of the edge of the mounting plate. When choosing the position make sure that you have enough space for mounting and connecting of the conductors. Once a suitable position is selected, it is necessary to remove relevant DIN rail or shorten the entire frame. For the mounting of the mounting plate it is not necessary to remove the mounting frame itself. Place the mounting plate over the prepared holes in the rear side of the enclosure.

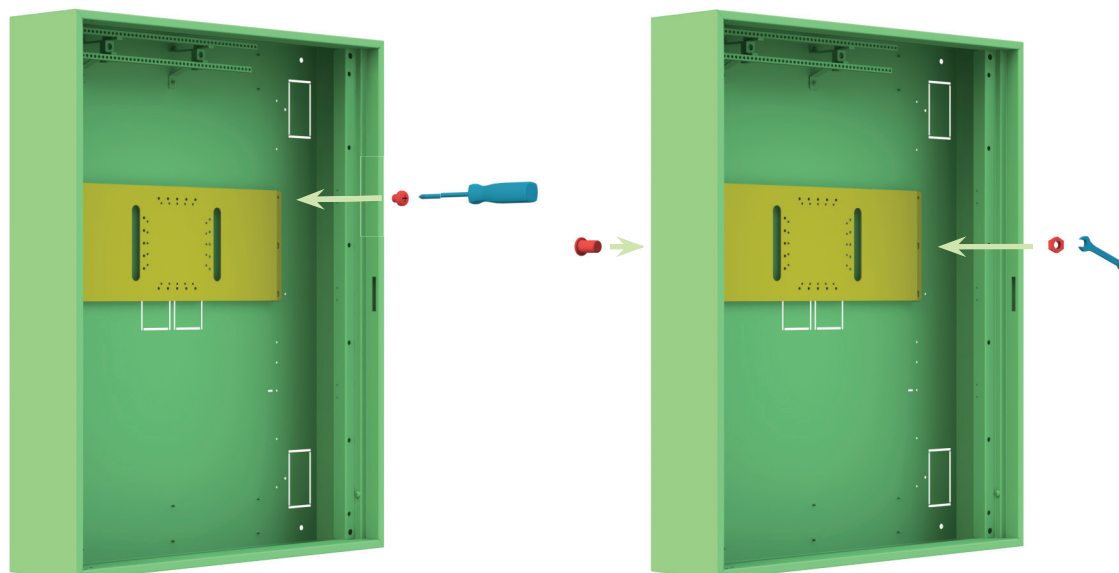

2. Fix the mounting plate using supplied screws. In case of surface-mounted versions MFS it is possible to fasten it also from the back side with the countersunk screw with nut to avoid exceeding over the outer surface profile.

# Technical Data MF

## Metal (sheet-steel) flat enclosures - description of technical solution

### Mounting of Ex9M line MCCB

Frame size and position of MCCB	Respective mounting holes	Frame size and position of MCCB	Respective mounting holes
Ex9M1 3P, vertical		Ex9M2 3P, vertical	
Ex9M1 4P, vertical		Ex9M2 4P, vertical	
Ex9M1 3P, horizontal		Ex9M2 3P, horizontal	
Ex9M1 4P, horizontal		Ex9M2 4P, horizontal	

3. Place the circuit breaker over the appropriate mounting holes on the mounting plate according to the table. The holes are equipped with metric threads, MCCB is mounted using supplied screws. So it can be mounted when the mounting plate is installed in the enclosure. MCCBs of frame size M2 are installed directly. Front panel of the device is in the same level with the front plates. For MCCBs of frame size M1 there are two possibilities of mounting depth. Maximum mounting depth is reached by direct mounting onto the plate. If it is required to have front panel in the same level with front plates, the mounting pads WG 10 are mounted first to the plate, then the MCCB over them.

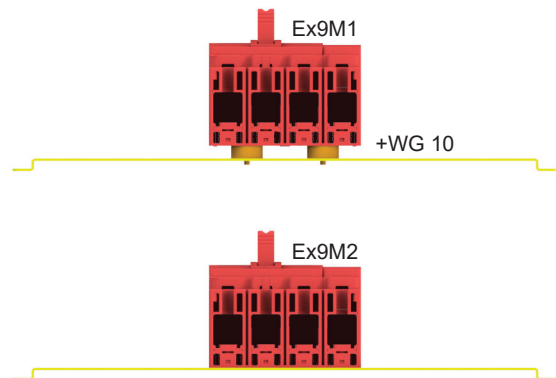
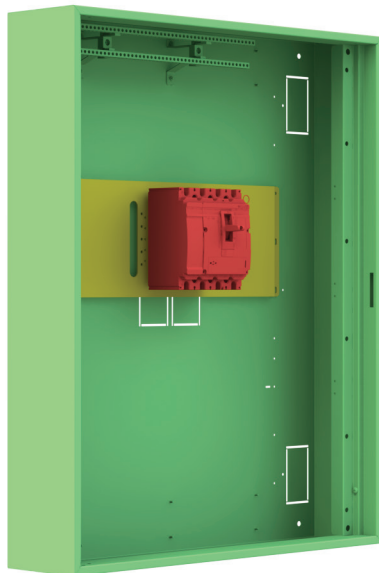

# Technical Data MF

## Metal (sheet-steel) flat enclosures - description of technical solution

### Mounting of Ex9M line MCCB

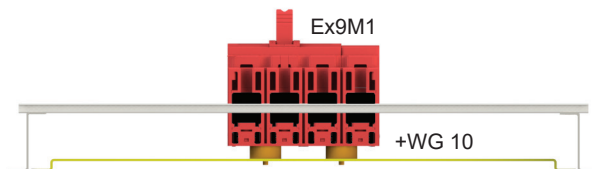

4. If it was removed and it is necessary for mounting of other devices, place the DIN mounting frame back to its place. Using of mounting plates MF UMP and MF MP M does not limit the use of the mounting frame with DIN rails. They can be installed simultaneously.

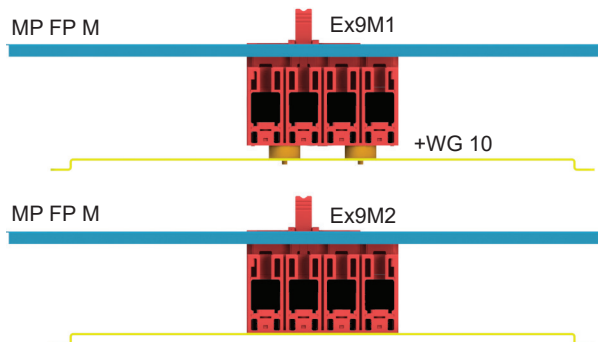

5. To cover the MCCB there can be used a special front plate MF FP. The suitable type is chosen according to the module width of the enclosure, frame size, number of poles and mounting position of the MCCB. In case of MCCB of frame size M1 it is necessary to mount the device on the mounting pads WG 10 to ensure correct mounting depth. Front plates should be properly tightened and screwed to ensure conductive connection and their grounding.



# Technical Data MF

## Metal (sheet-steel) flat enclosures - description of technical solution

### Mounting of universal mounting plate

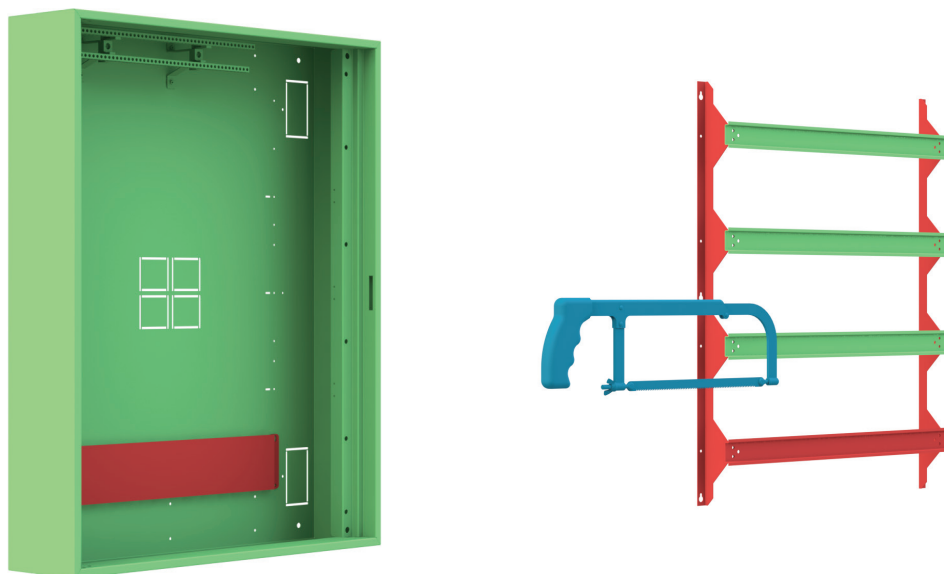

#### Workflow:

1. Place the mounting plate MF MP to the required position. The plate can be placed in the position of middle front plates. In case of mounting into position of the outer front plates, the right position is given by inner edge of the front plate which should be equal with vertical position of the edge of the mounting plate. When choosing the position make sure that you have enough space for mounting and connecting of the conductors. Once you have selected suitable position it is possible to let mounting frame complete and remove relevant DIN rail only or shorten the entire frame.

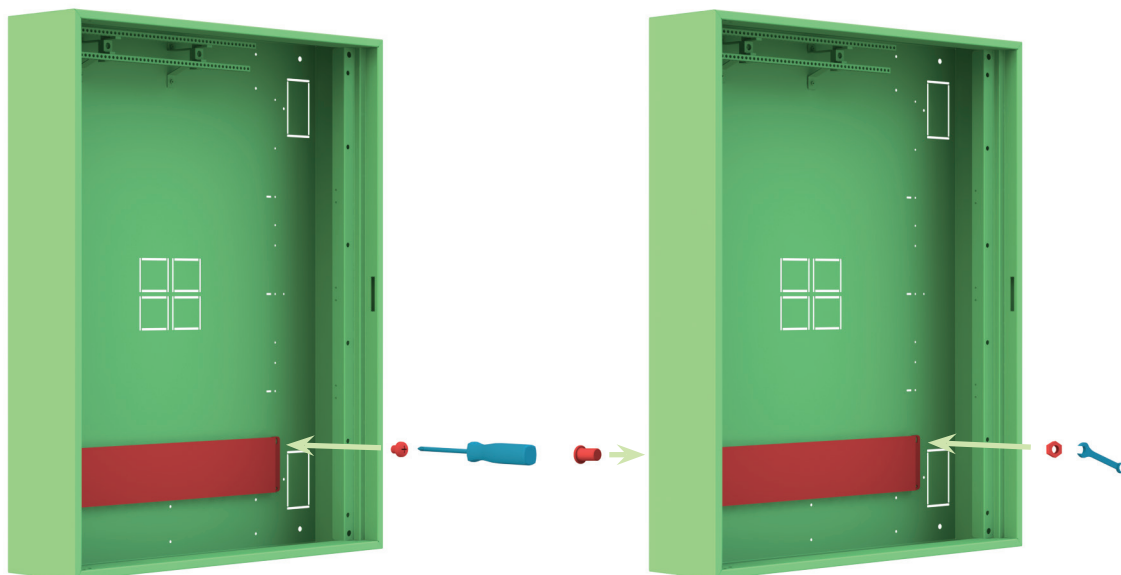

2. Fix the mounting plate using the supplied screws. In case of surface-mounted versions MFS it is possible to fasten it also from the back side with the countersunk screw with nut to avoid exceeding over the outer surface profile.
3. Using of mounting plates MF UMP and MF MP M does not limit the use of the mounting frame with DIN rails. In case of mounting of MCCB or other device with similar mounting depth the relevant DIN rail must be removed.

# Technical Data MF

## Metal (sheet-steel) flat enclosures - description of technical solution

### Cable fixing rail MF CFR

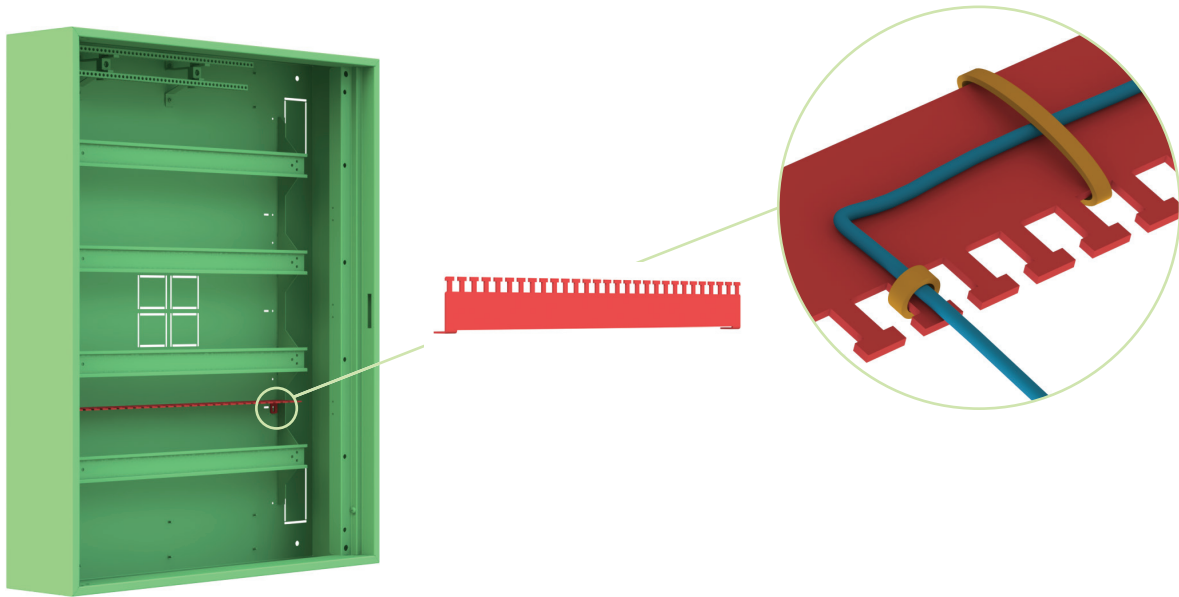

To organize conductors and prevent their tension against the terminals, enclosures MF can be equipped with cable fixing rail MF CFR. Conductors can be fixed to them e.g. using cable ties.

#### Workflow:

1. Place the cable fixing rail in the desired position in the enclosure so that the mounting holes are in alignment with the holes in the rear side of the enclosure.
2. Fasten it with supplied screws. In case of surface-mounted versions MFS it is possible to fasten it also from the back side with the countersunk screw with nut to avoid exceeding over the outer surface profile.
3. Arrange the conductors to the required position.
4. Fix the wires e.g. with plastic cable ties as shown in the picture.
5. Mounting of cable fixing rails does not require any changes and can be used together with the DIN rail mounting frame.

# Technical Data MF

## Metal (sheet-steel) flat enclosures - description of technical solution

### Horizontal space separator / shelf MF HS

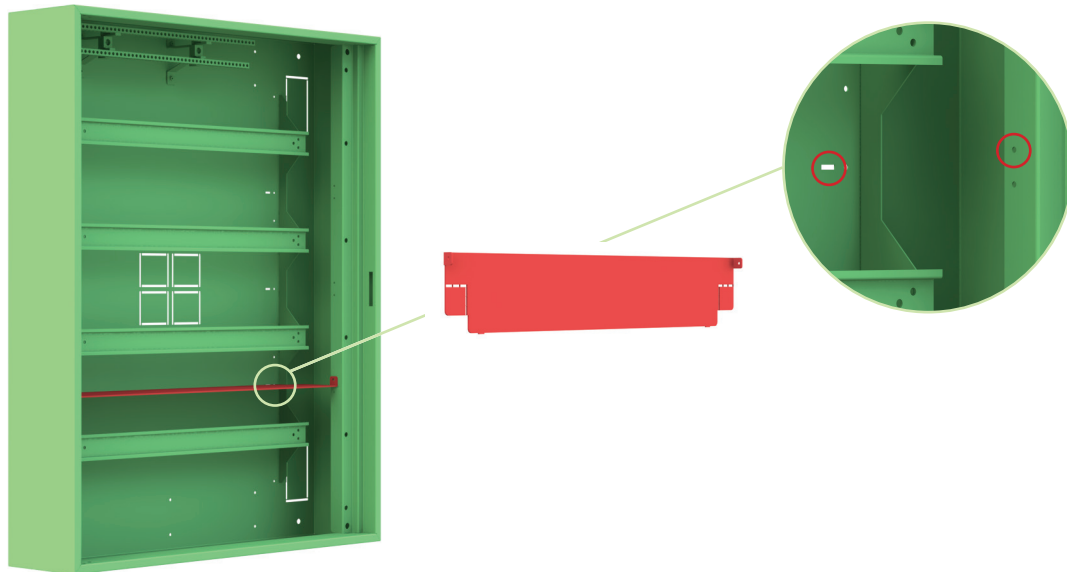

Horizontal separators MF HS are used for electromagnetic shielding (e.g. between electric and electronic part of the installation, SPDs, etc.) or to the division of space in the enclosures. They can be used also as the carrier shelves.

#### Workflow:

1. Select suitable position for the separator. Desing of enclosures assumes their positioning in the space between two DIN rails.
2. Using of the separator does not require changes on the mounting frame and can be used together with it.
3. Place the tabs on bottom side of the horizontal separator into the rectangular holes in the rear side of the enclosure from the inside.
4. Fix the separator to the sides of the enclosure with the supplied screws.
5. For fixing it is necessary to use provided screws with fan-shaped washers and ensure proper tightening so that there is ensured a conductive connection between the separator and the enclosure.
6. When it is used as a carrier shelf, make sure the maximum load capacity of 2 kg is not exceeded.

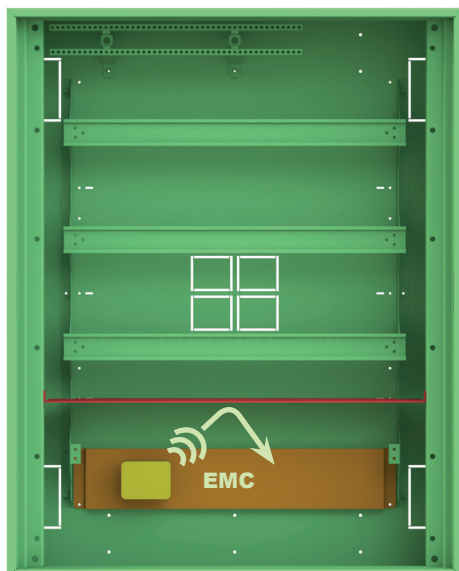

# Technical Data MF

## Metal (sheet-steel) flat enclosures - description of technical solution

### Variants of front plates

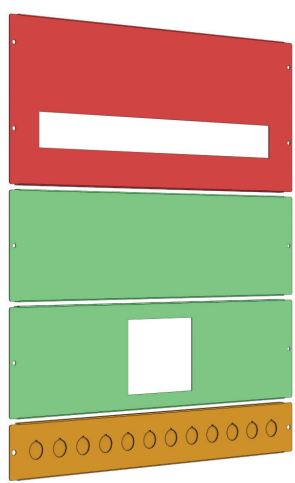

The enclosures are supplied with front plates with device cutout 45 mm (two wide outer plates and the rest standard middle plates). Number of front plates is determined by the size of the enclosure, see. p. 20. If necessary, basic plates can be replaced by other versions. Possible variants are depicted in the picture below.

#### Outer front plates - variants

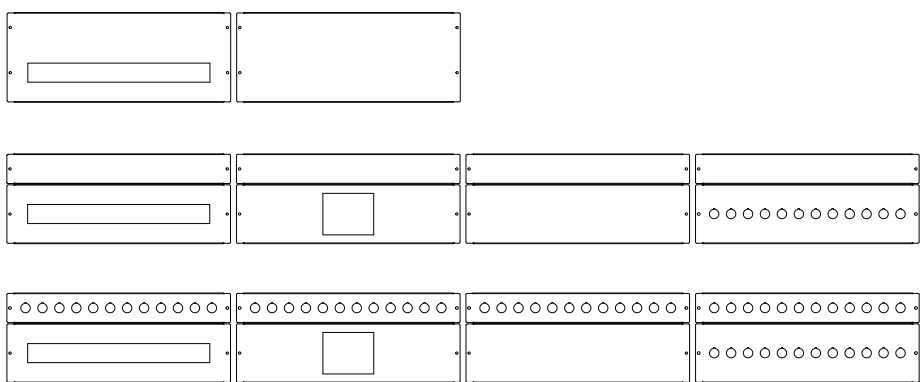

#### Standard middle front plates - variants



# Technical Data MF

## Metal (sheet-steel) flat enclosures - description of technical solution

### Grounding of front plates

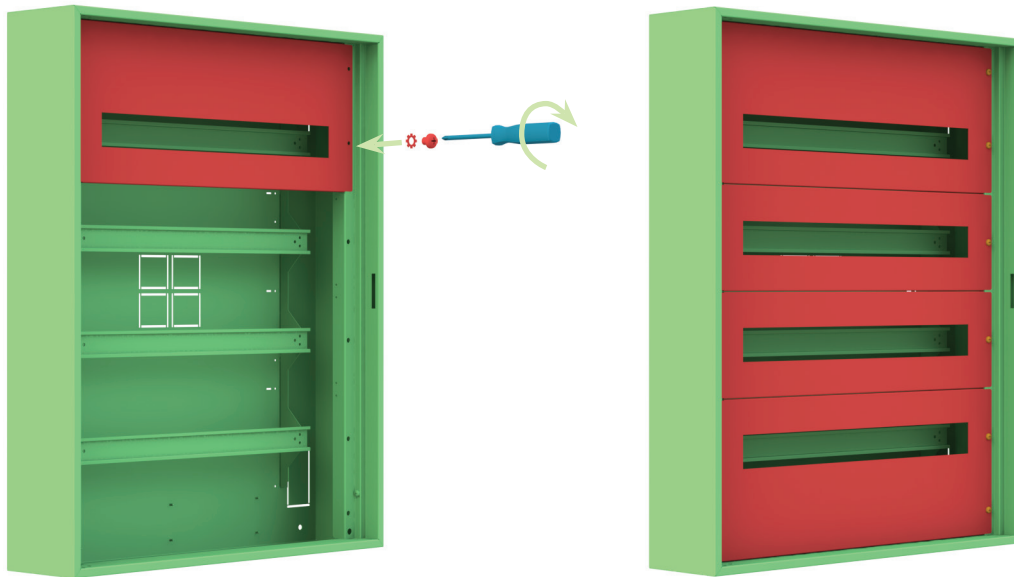

Front plates for covering of internal space in enclosure are offered in various versions.

They should be properly tightened and screwed to ensure conductive connection and their grounding.

#### Workflow:

1. Arrange the front plates to required arrangement.

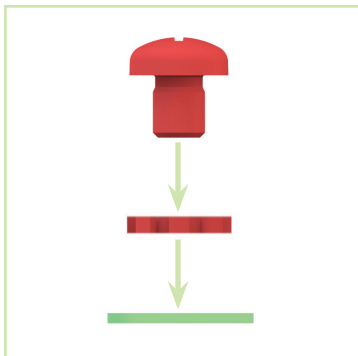

2. Using supplied screws tighten them via self-grounding washers.

# Technical Data MF

## Metal (sheet-steel) flat enclosures - description of technical solution

### Noiseless door construction

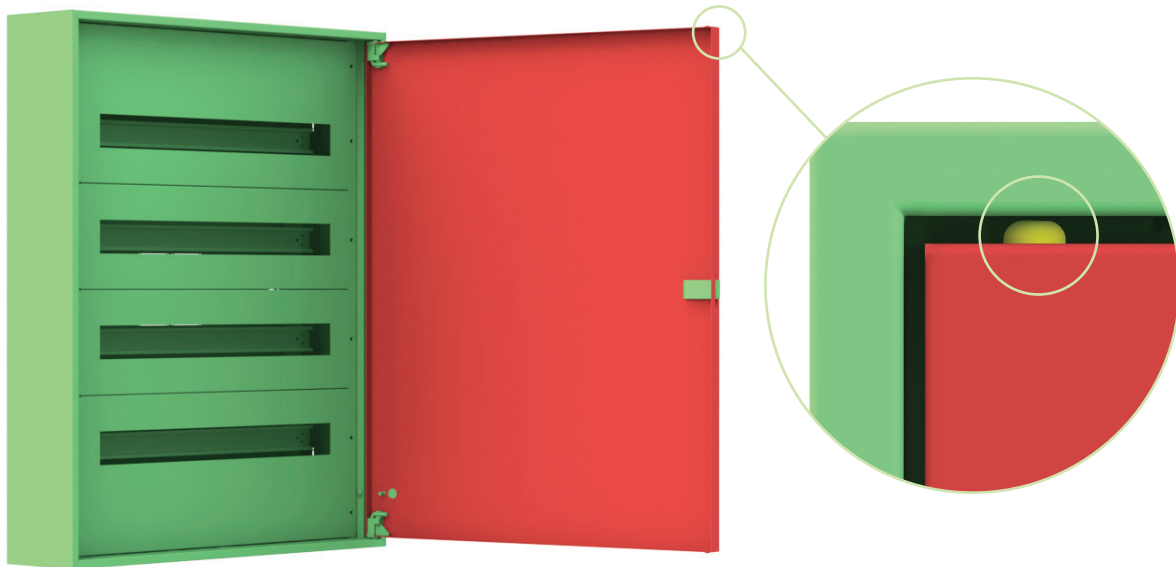

The design and construction of the door and door frame in the MF enclosures reduces noise for example during vibration of the building.

- When closed, the door are fixed in their position not only by lock and hinges, but also with plastic pads preventing movements and direct impact into the door frame.



- Horizontal door edges are shortened to avoid contact with the frame all around its circumference. This is reflected especially in cases where the enclosure is mounted into/onto uneven surface. This solution also optically reduces visibility of uneven mounting (twisting of door) caused by uneven wall.

# Technical Data MF

## Metal (sheet-steel) flat enclosures - description of technical solution

### Rigid and robust construction



**Enclosures MF are characterized with high stiffness thanks to robust material used.**

- They are less susceptible to damage during transport, installation and also during using.
- There is no deformation even at higher weight load by devices.
- There is no sag of the door, even when door are not fully closed. And it applies also if there are mounted e.g. panel mounted devices.

# Technical Data MF

## Metal (sheet-steel) flat enclosures - description of technical solution

### Reversible door, hinges



Used door hinges allow easy disassembling and change of the opening direction of the door from left to right and vice versa.

#### Workflow:

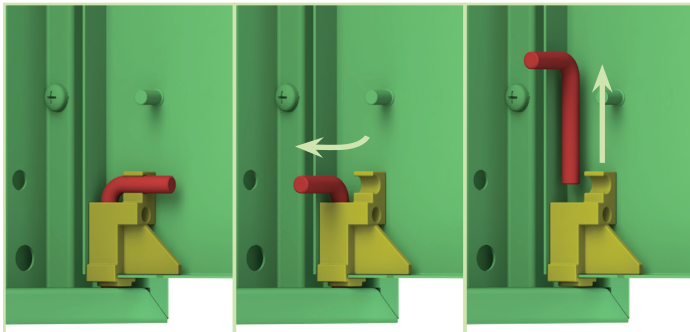

1. Loosen and pull out the hinge pins.
2. Detach the door and place it to the opposite side of the enclosure.



3. Push the hinge pins back and lock them in position.



# Technical Data MF

## Metal (sheet-steel) flat enclosures - description of technical solution

### Lock-key mounting

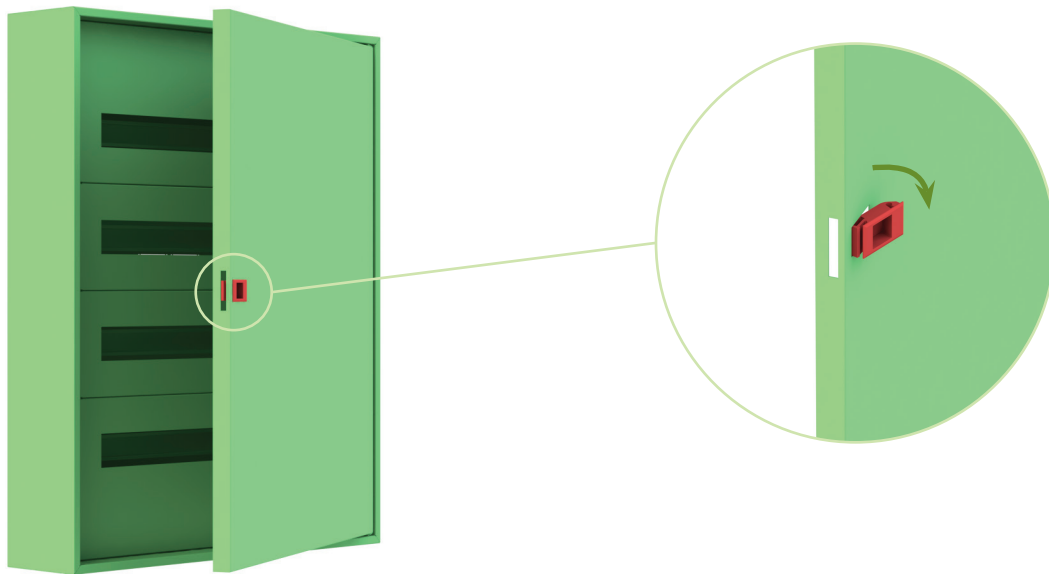

It is possible to replace the standard supplied plastic door lock with lock-key series MF DLK. For the mounting into the lock hole it is necessary to use mounting set MF LMS.

#### Workflow:

1. Pull out the plastic lock.
2. Fit the mounting set MF LMS onto the hole according to the picture.

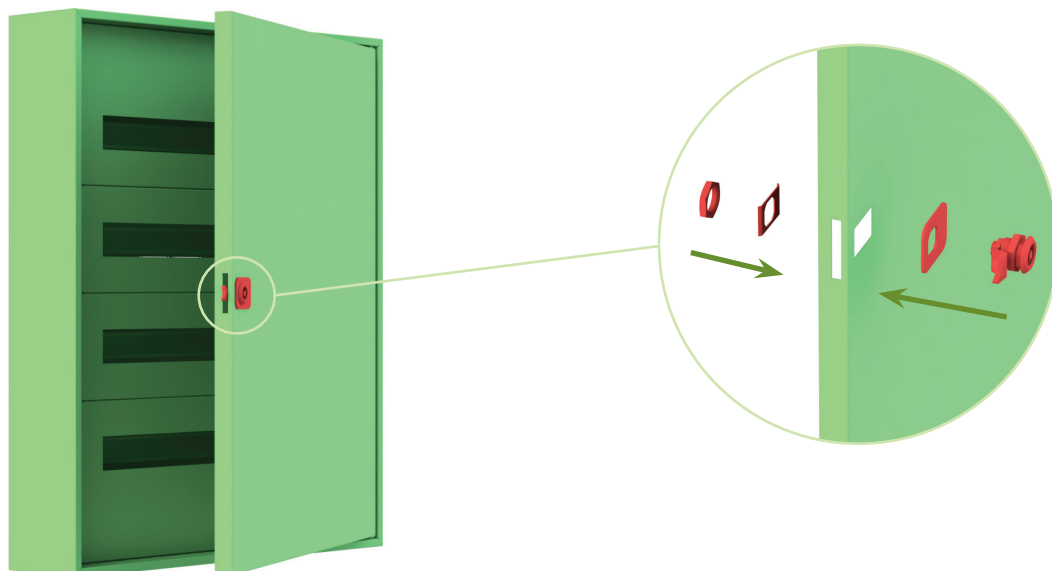

3. Insert body of MF DLK lock-key through the hole in MF LMS and fix it with the nut from the other side.
4. Fix the cam to lock body with supplied screw. Pay attention to its correct position to the opening in the door frame.