



# STR1-SAFM10P5

## STR1

NON-CONTACT SAFETY SWITCHES

**SICK**  
Sensor Intelligence.



### Ordering information

Type	Part no.
STR1-SAFM10P5	1069568

Consists of sensor (1073227) and actuator (1073221)

Other models and accessories → [www.sick.com/STR1](http://www.sick.com/STR1)



### Detailed technical data

#### Features

<b>System part</b>	Sensor with actuator
<b>Sensor principle</b>	RFID
<b>Number of safe outputs</b>	2
<b>Auxiliary contact (AUX)</b>	1 (Switching behavior complementary to OSSDs)
<b>Safe switch on distance <math>S_{ao}</math></b>	14 mm (-10 ... +70 °C) <sup>1)</sup> 10 mm (-30 ... -10 °C) <sup>1)</sup>
<b>Safe switch off distance <math>S_{ar}</math></b>	28 mm <sup>1)</sup>
<b>Active sensor surfaces</b>	3
<b>Active sensor surface</b>	Top, sides (left, right) <sup>2)</sup>
<b>Actuation directions</b>	5
<b>Coding</b>	Universally coded

<sup>1)</sup> Values apply for the frontal alignment of the sensor to the actuator. A detailed display of the alignment options and values can be found in the operating instructions.

<sup>2)</sup> For details see operating instructions.

#### Safety-related parameters

<b>Safety integrity level</b>	SIL 3 (IEC 61508)
<b>Category</b>	Category 4 (EN ISO 13849)
<b>Performance level</b>	PL e (EN ISO 13849)
<b>PFH<sub>D</sub> (mean probability of a dangerous failure per hour)</b>	$5,21 \times 10^{-9}$
<b>T<sub>M</sub> (mission time)</b>	20 years (EN ISO 13849)
<b>Type</b>	Type 4 (EN ISO 14119)
<b>Actuator coding level</b>	Low coding level (EN ISO 14119)
<b>Safe state in the event of a fault</b>	At least one safety-related semiconductor output (OSSD) is in the OFF state.

## Functions

<b>Safe series connection</b>	None, only individual wiring (with diagnostics)
-------------------------------	---

## Interfaces

<b>Connection type</b>	Cable, 5-wire
Length of cable	10 m
Long connecting cable	≤ 200 m
Cable diameter	5.5 mm
Conductor cross section	0.12 mm <sup>2</sup>
Bend radius (with fixed installation)	> 8 x cable diameter
Bend radius (with moving cable)	> 12 x cable diameter
Cable material	PVC
Conductor material	Copper
<b>Display elements</b>	LEDs
Diagnostics indicator	✓
Status display	✓

## Electrical data

<b>Protection class</b>	III (IEC 61140)
<b>Classification according to cULus</b>	Class 2
<b>Supply voltage V<sub>s</sub></b>	24 V DC (19.2 V DC ... 28.8 V DC)
<b>Power consumption</b>	50 mA
<b>Type of output</b>	Self-monitoring semiconductor outputs (OSSDs)
<b>Output current</b>	≤ 100 mA
<b>Response time</b>	40 ms <sup>1)</sup>
<b>Release time</b>	100 ms <sup>1) 2)</sup>
<b>Risk time</b>	80 ms <sup>1) 3)</sup>
<b>Switch-on time</b>	2.5 s <sup>4)</sup>

<sup>1)</sup> In a safe series connection, each downstream safety switch increases the system response time. More response times can be found in the operating instructions.

<sup>2)</sup> Response time on approach to the enable zone.

<sup>3)</sup> Detection time for internal oder external faults (e.g., short-circuit or cross-circuit of output signal switching devices). Follow the detailed information in the operating instructions.

<sup>4)</sup> The time specified applies to one sensor after the supply voltage has been applied to the safety switch. In a safe series connection, 0.1-s must be added for each sensor. An additional 0.5-s per taught-in actuator must be added for uniquely coded and permanently coded sensors.

## Mechanical data

<b>Dimensions (W x H x D)</b>	40 mm x 18 mm x 26 mm
<b>Weight</b>	423 g
<b>Housing material</b>	VISTAL®

## Ambient data

<b>Enclosure rating</b>	IP67, IP69K (EN 60529, ISO 20653)
<b>Ambient operating temperature</b>	-30 °C ... +70 °C <sup>1)</sup>
<b>Storage temperature</b>	-30 °C ... +70 °C

<sup>1)</sup> Only applies for safety switches whose serial numbers begin with number series 1825\*\*\*\* or higher. For safety switches whose serial numbers deviate from this, an ambient operating temperature of -10 °C ... +70 °C applies. The serial number is displayed on the safety switch over the data matrix code.

<b>Vibration resistance</b>	10 Hz ... 55 Hz, 1 mm (IEC 60068-2-6)
<b>Shock resistance</b>	30 g, 11 ms (IEC 60068-2-27)
<b>EMC</b>	EN IEC 61326-3-1, EN IEC 60947-5-2, EN IEC 60947-5-3, EN 300330 V2.1.1

<sup>1)</sup> Only applies for safety switches whose serial numbers begin with number series 1825\*\*\*\* or higher. For safety switches whose serial numbers deviate from this, an ambient operating temperature of -10 °C ... +70 °C applies.  
The serial number is displayed on the safety switch over the data matrix code.

### Classifications

<b>ECLASS 5.0</b>	27272403
<b>ECLASS 5.1.4</b>	27272403
<b>ECLASS 6.0</b>	27272403
<b>ECLASS 6.2</b>	27272403
<b>ECLASS 7.0</b>	27272403
<b>ECLASS 8.0</b>	27272403
<b>ECLASS 8.1</b>	27272403
<b>ECLASS 9.0</b>	27272403
<b>ECLASS 10.0</b>	27272403
<b>ECLASS 11.0</b>	27272403
<b>ECLASS 12.0</b>	27274601
<b>ETIM 5.0</b>	EC001829
<b>ETIM 6.0</b>	EC001829
<b>ETIM 7.0</b>	EC001829
<b>ETIM 8.0</b>	EC001829
<b>UNSPSC 16.0901</b>	39122205

### Dimensional drawing (Dimensions in mm (inch))

“Flat” actuator

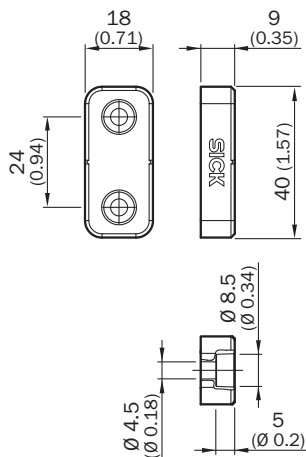

Sensor with cable

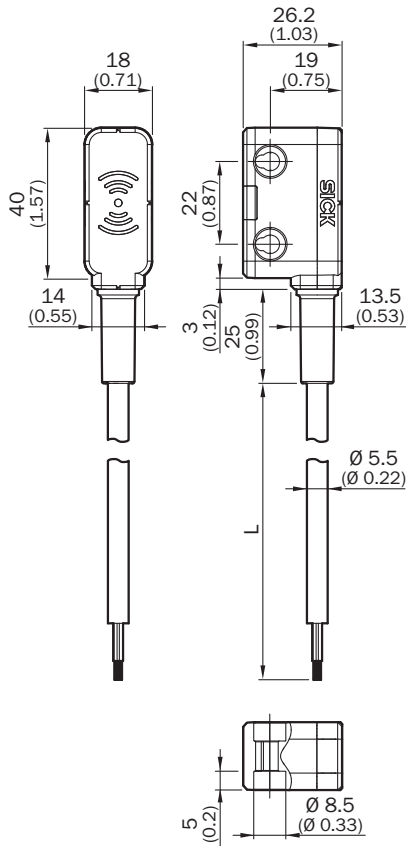

Response range

“Flat”/“Mini” actuator, active side sensor surface

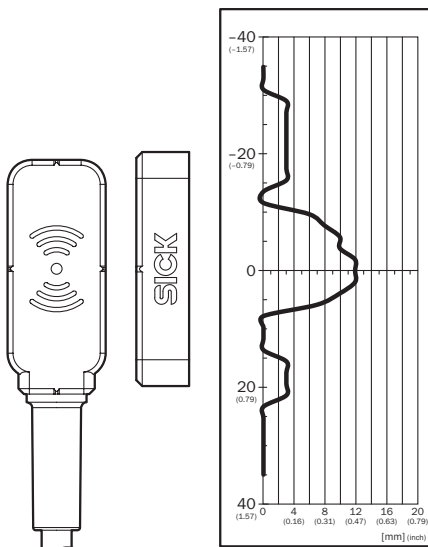

Assured switch on distance  $S_{ao}$  9 mm. Observe border areas for parallel approach: a minimum distance of 4 mm (typical) must be upheld when the actuator moves laterally to the sensor surface. This prevents early triggering due to the side preparation areas.

“Flat”/“Mini” actuator, active front sensor surface

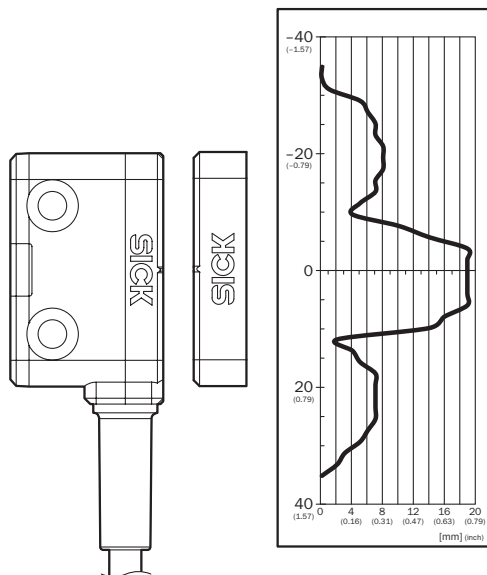

Assured switch on distance  $S_{ao}$  14 mm. Observe border areas for parallel approach: a minimum distance of 10 mm (typical) must be upheld when the actuator moves laterally to the sensor surface. This prevents early triggering due to the side preparation areas.

### Pin assignment

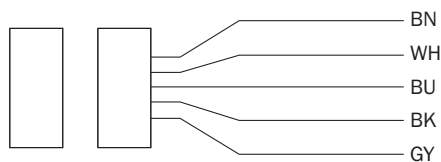

Brown	Voltage supply 24 V DC
White	OSSD 1
Blue	Voltage supply 0 V DC
Black	OSSD 2
Grey	Aux output (not safe)

### Recommended accessories

Other models and accessories → [www.sick.com/STR1](http://www.sick.com/STR1)

Brief description	Type	Part no.
Nuts and screws		
 10 pieces	Safety screws M4 x 14	5333570

## SICK AT A GLANCE

SICK is one of the leading manufacturers of intelligent sensors and sensor solutions for industrial applications. A unique range of products and services creates the perfect basis for controlling processes securely and efficiently, protecting individuals from accidents and preventing damage to the environment.

We have extensive experience in a wide range of industries and understand their processes and requirements. With intelligent sensors, we can deliver exactly what our customers need. In application centers in Europe, Asia and North America, system solutions are tested and optimized in accordance with customer specifications. All this makes us a reliable supplier and development partner.

Comprehensive services complete our offering: SICK LifeTime Services provide support throughout the machine life cycle and ensure safety and productivity.

For us, that is “Sensor Intelligence.”

## WORLDWIDE PRESENCE:

Contacts and other locations –[www.sick.com](http://www.sick.com)