

Part number

JCVI 10 LP



Bulkhead mounting housing, JEI®-V series, with 1 lever, size "57.27", with plastic cover

Product description

Product type	Bulkhead mounting housing
Series	JEI®-V
Closing type	With 1 lever
Size	Size 57.27
Cable entry	Without cable entry
Specification	With plastic cover

Technical data

IP degree of protection IP65

Further technical details

Weight	150,00 g
Operating temperature range (min, max)	-40°C...+125°C

Material properties

Other materials	Lever: Galvanized steel Gasket: NBR
Colour	RAL 7040 grey

Approvals / Standards

Certifications	DNV, BV
UL	ECBT2
cUL	ECBT8

General ordering information

EAN13 code 8015747137706

Packaging Information

Packaging length	370,00 mm
Packaging height	140,00 mm
Packaging width	210,00 mm
Packaging weight	3,28 kg
Packaging volume	10,88 dm ³
Packaging description	Carton box
Packaging quantity	20 Pcs
Packaging EAN code	8015747144018
Sub-packaging weight	0,82 kg
Sub-packaging description	Plastic packaging
Sub-packaging quantity	5 Pcs
Sub-packaging EAN barcode	8015747140195

Part number
JCVI 10 LP



Catalogue drawings



Catalogue drawings

JCVI LP

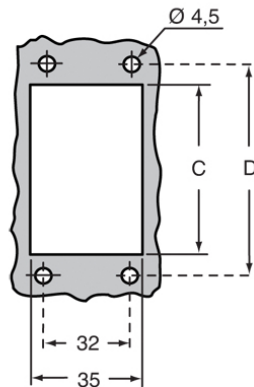
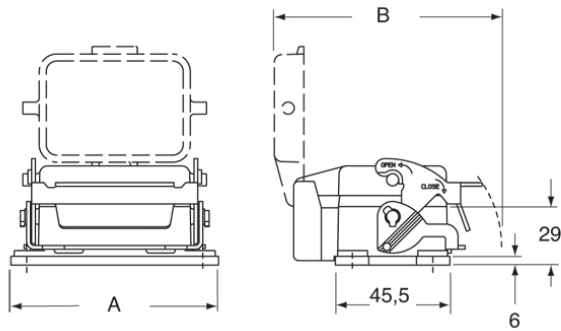

	A	B	C	D
JCVI 06 LP	82,5	89	52	70
JCVI 10 LP	95,5	94	65	83
JCVI 16 LP	115,5	94	86	103
JCVI 24 LP	142,5	94	112	130

Notes

Dimensions shown in mm are not binding and may be changed without notice.