

Yuma 240 LED

astro

GB Products with electronic ballasts / drivers must not be installed on the same electrical circuits as products with inductive loads, for example magnetic fluorescent luminaires, motors or ventilators. Inductive loads can generate excessive voltage surges which can damage electronic ballasts.

This product contains a light source of energy efficiency class E to Regulation (EU) No 2019/2015 (01/09/2021).

The light source in this luminaire shall only be replaced by the manufacturer or his service agent or a similar qualified person.

Please read the instructions carefully before commencing assembly

Live: Normally Brown / Red
Neutral: Normally Blue / Black
Earth: Normally Green / Yellow

FR Les luminaires utilisant un ballast électronique / drivers ne peuvent être installés sur le même circuit que des appareils avec charges inductives, tels que luminaires fluorescents magnétiques, moteurs et ventilateurs. Les charges inductives peuvent générer des voltages excessifs et ainsi endommager les ballasts électroniques.

Ce produit contient une source lumineuse de classe d'efficacité énergétique E selon le règlement (UE) n° 2019/2015 (01/09/2021).

La source lumineuse de ce luminaire devrait seulement être remplacée par le fabricant ou par un de ses agents de maintenance ou par une personne qualifiée similaire.

Lire attentivement les instructions avant de commencer le montage

Phase: Normalement Brun / Rouge
Neutre: Normalement Bleu / Noir
Terre: Normalement Vert / Jaune

IT Tutti i prodotti che includono ballast elettronici / driver non devono essere installati sugli stessi circuiti elettrici come anche prodotti con carichi induttivi quali lampadari a fluorescenza magnetica, motori e ventilatori. I carichi induttivi possono generare scariche eccessive che possono danneggiare i ballast.

Questo prodotto contiene una sorgente luminosa di classe di efficienza energetica E secondo il regolamento (UE) n° 2019/2015 (01/09/2021).

La sorgente di luce in questo apparecchio può essere sostituita solo dal produttore o da un suo agente di servizio o da una persona qualificata simile.

Leggere attentamente le istruzioni prima di cominciare l'assemblaggio

Cavo positivo: normalmente marrone o rosso
Cavo neutro: normalmente blu o nero
Cavo terra: normalmente verde o giallo

DE Produkte mit elektronischen Vorschaltgeräten/ Treibern dürfen nicht im selben Stromkreislauf installiert werden wie Verbraucher mit induktiven Lasten, z.B. magnetische Leuchtstofflampen, Motoren oder Ventilatoren. Induktive Lasten können übermäßige Spannungsspitzen erzeugen, die elektronische Vorschaltgeräte beschädigen könnten.

Dieses Produkt enthält eine Lichtquelle der Energieeffizienzklasse E gemäß Verordnung (EU) Nr. 2019/2015 (01/09/2021).

Die Lichtquelle in dieser Leuchte darf nur vom Hersteller oder seinem Servicemitarbeiter oder einer ähnlich qualifizierten Person ausgetauscht werden.

Lesen sie bitte die anweisungen sorgfältig durch, bevor sie mit dem zusammenbauen beginnen

Phase: Normalerweise Braun / Rot
Nulleiter: Normalerweise Blau / Schwarz
Erde: Normalerweise Grün / Gelb

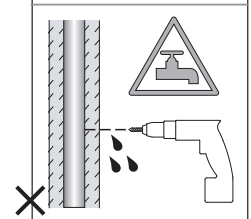
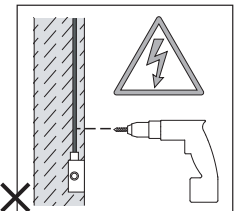
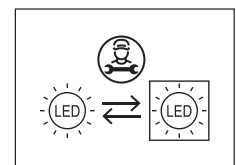

For Wall Use Only
Usage mural uniquement
Solo per uso a parete
Nur zur Verwendung als Wandleuchte

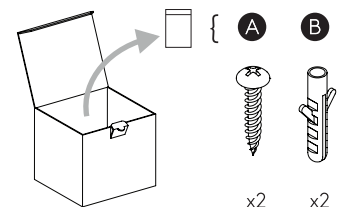
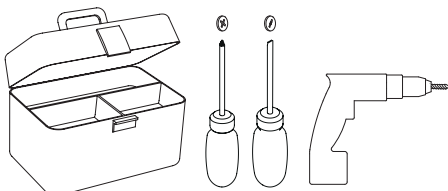

1

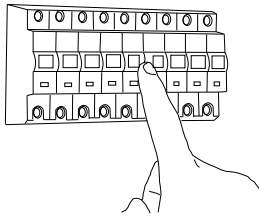

Turn off power
Couper le courant! /
Spegnere la corrente! /
Strom Abhalten!

2

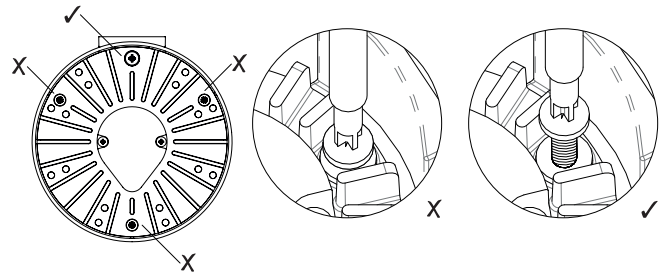
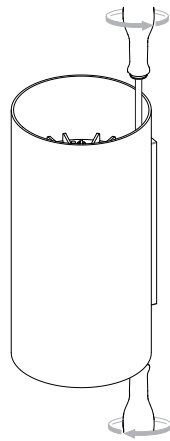

3

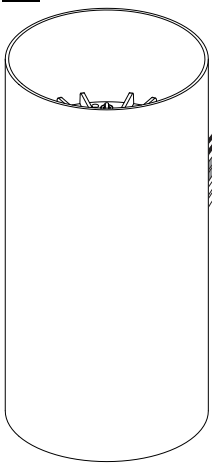

3a



3b

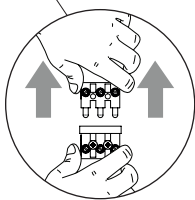

4

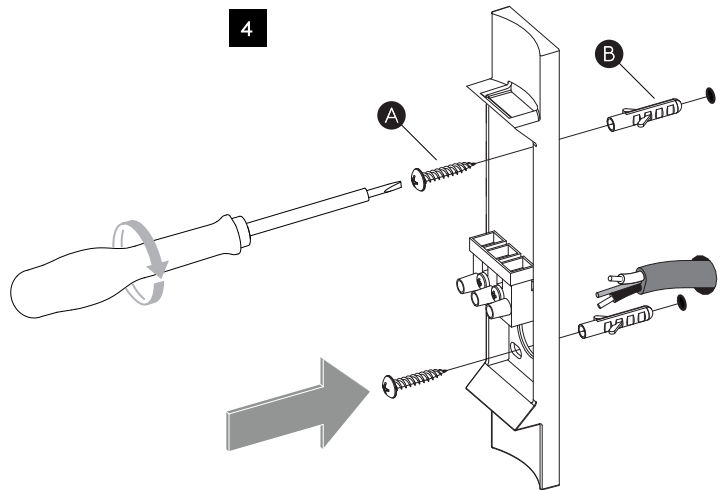

5

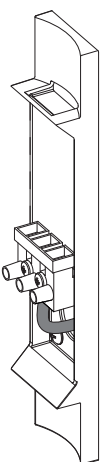

Neutral/Neutre/Neutro/Nulleiter
Blue/Black
Bleu/Noir
Azzurro/Nero
Blau/Schwarz

Earth/Terre/Tierra/Erde
Green/Yellow
Vert/Jaune
Verde/Giallo
Grün/Gelb

Live/Phase/Fase
Brown/Red
Brun/Rouge
Marrone/Rosso
Braun/Rot

Earth/Terre/Tierra/Erde
Green/Yellow
Vert/Jaune
Verde/Giallo
Grün/Gelb

6

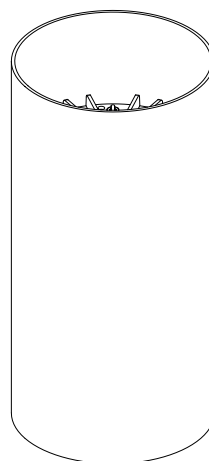

6a

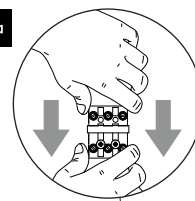

6b

7

