

KOPA

















| CODE | COULEUR | KLEUR | FARBE | COLOR | AC | LED | T° (K) | LED Lumen |
|-----------|------------|-----------|-----------|------------|---------|-----|--------|-----------|
| OU438WW24 | ANTHRACITE | ANTRACIET | ANTHRAZIT | ANTHRACITE | AC 230V | 9W | 3000K | 695 Lm |

F Ce produit contient 1 source(s) lumineuse(s) d'efficacité énergétique E.

D Dieses Produkt enthält 1 Lichtquelle(n) mit E energieeffizient.

N Dit product bevat 1 lichtbron(nen) energiezuinig E.

E This product contains 1 light source(s) of energy efficiency E.

| F | N | D | E |
|--|--|---|---|
|  Montage sur un mur uniquement. Ce luminaire éclaire avec 2 zones d'éclairage. | Wandmontage alleen. Deze lamp verlicht 2 verschillende zones. | Nur für Wandmontage. Diese Lampe beleuchtet zwei verschiedene Zonen. | Wall mounting only. This lamp illuminates on 2 areas. |
|  Usage extérieur. | Buitengebruik. | Außengebrauch. | Outdoor use. |
|  Etanchéité aux poussières. Protection contre les jets d'eau. | Stofdicht. Bescherming tegen waterstralen. | Staubdicht. Schutz gegen Wasserstrahlen. | Protected against the ingress of dust. Protected against jets of water. |
|  Protection contre une énergie de choc de 2 Joules. | Bescherming tegen een impact-energie van 2 Joule. | Schutz gegen eine Stoßenergie von 2 Joule. | Protection against an impact energy of 2 Joules. |
|  Produit à isolation principale qui comporte des dispositifs reliant l'ensemble de ses parties métalliques accessibles au conducteur de protection. | Product met hoofdisolatie, met een apparaat dat alle metalen delen die toegankelijk zijn met de beschermingsleiding verbindt. | Beleuchtung mit Hauptisolierung, mit einem Gerät welches alle seine Metallteile die zugänglich sind mit dem Schutzleiter verbindet. | Earth wire . Fixture equipped with primary insulation only. |
|  Homologation CE. | CE gekeurd. | CE Genehmigung. | Product in conformity CE. |
|  Risque photobiologique RG1 | Fotobiologisch risico RG1 | Photobiologisches Risiko RG1 | Photobiological risk RG1 |
|  Testé à 650°. | Getest bij 650°. | Getestet bei 650°. | Test on 650°. |
|  Installation sur surfaces normalement inflammables. | Installatie op normaal ontvlambare oppervlakken. | Installation auf normal entflammbaren Oberflächen. | Suitable for installation on normally flammable surfaces. |
|  Produit sous haute température en fonctionnement. Interdiction d'avoir des objets ou des parois proches pendant toute la durée de dégagement de chaleur. Même après extinction. | Product onder hoge temperatuur bij werking. Verbod voorwerpen of muren nabij te hebben gedurende de hele oververhitting, zelfs na uitdoving. | Produkt unter hoher Temperatur bei Betrieb. Verbot Gegenstände oder Wände in der Nähe zu haben während der ganzen Dauer der Überhitzung, auch nach dem Erlöschen. | Produkt emitting high temperature. Can not be installed too close of walls and objects even after extinction. |
|  Attention ! Risque d'électrocution. Extinction de la source électrique avant chaque manipulation. | Let op gevaar voor elektrocuteren. Afluiten van de stroom voor iedere manipulatie. | Achtung Gefahr eines elektrischen Schlags. Stromquelle abschliessen bevor jede Manipulation. | Attention! Risk of electric shock. Switch off before any intervention on the luminaire. |
|  Alimentation incluse. | Voeding inbegrepen. | Stromversorgung einbegriffen. | Power supply included. |
|  A connecter à un courant alternatif de 230V. | Aan te sluiten op een AC-circuit van 230V. | An eine AC-Schaltung von 230 Volt an zu schliessen. | To connect to a 230V AC circuit. |
|  Garantie 3 ans. | 3 jaar garantie. | 3 Jahre Garantie. | 3 years warranty. |
|  L'appareil doit être éliminé dans des centres de ramassage spécialisés. | Het toestel moet worden afgevoerd in een speciale collectie centra. | Das Gerät muss von einer speziellen Sammelstelle entsorgt werden. | Luminaire must be disposed in specialized collection center. |
|  Driver remplaçable par un électricien. | Driver vervangbaar door elektricien. | Driver von einem Elektriker austauschbar. | Replaceable control gear by an electrician. |
|  LED non remplaçable. | Niet-vervangbare lichtbron. | Lichtquelle nicht austauschbar. | Non-replaceable light source. |

| | | | |
|---|--|---|---|
| <p> • Toutes les sources de chaleur (ampoules, transformateurs, convertisseurs, ...) doivent obligatoirement être suffisamment espacées et ventilées pour empêcher l'incendie. Veuillez nous contacter lors de cas particulier de montage.</p> <p>• Ce document doit être conservé pendant toute la durée de vie du produit.</p> <p>• Le produit ne sera ni échangé, ni repris en cas d'erreur de montage.</p> <p>• INDIGO se réserve le droit de modifier les spécifications sans préavis.</p> <p>Le luminaire doit être monté et installé par un professionnel et il sert uniquement à éclairer.</p> | <p>• Alle warmtebronnen (lampen, transformatoren, omvormers, ...) moeten voldoende worden geventileerd en op een voldoende afstand zijn om de brand te voorkomen. Neem contact met ons op in geval van speciale montage.</p> <p>• Dit document moet worden bewaard voor de hele levensduur van het product.</p> <p>• Het product wordt nog terug genomen, nog vervangen bij foutieve installatie.</p> <p>• INDIGO behoudt zich het recht om specificaties te wijzigen zonder voorafgaande kennisgeving.</p> <p>De armatuur moet worden gemonteerd en geïnstalleerd door vakmensen en dient alleen om te verlichten.</p> | <p>• Alle Wärmequellen (Lampen, Transformatoren, Umformer, ...) müssen ausreichend belüftet sein und einen genügenden Abstand haben um das Feuer zu verhindern. Bitte kontaktieren Sie uns bei einer speziellen Montage.</p> <p>• Dieses Dokument muss für die ganze Lebensdauer des Produkts aufbewahrt werden.</p> <p>• Das Produkt wird weder zurückgenommen noch ungetauscht bei falscher Installation.</p> <p>• INDIGO behält das Recht für Spezifikationen, ohne vorherige Ankündigung, zu ändern.</p> <p>Die Leuchte darf nur von Fachleuten montiert und installiert werden und dient nur zur Beleuchtung.</p> | <p>• All heat source (bulbs, transformers, converters, ...) are required to be sufficiently spaced and ventilated to prevent the fire.</p> <p>Please contact us in case of special installation.</p> <p>• This document must be kept for the all lifetime of the product.</p> <p>• The product can't be returned or exchanged following to installation error.</p> <p>• INDIGO reserve the right to modify specifications without prior notice.</p> <p>The fixture should be assembled and installed by professionals and used only to illuminate.</p> |
|---|--|---|---|

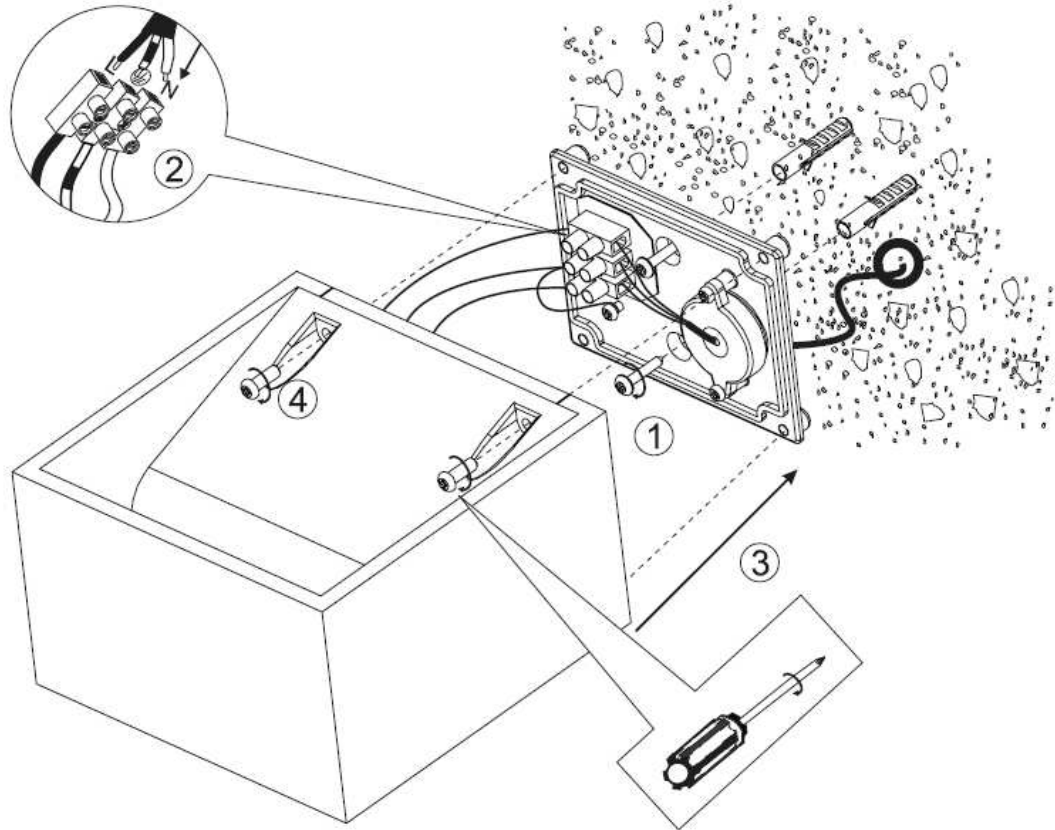

| | | |
|--|---|--|
| | L | = Brun-Bruin-Braun-Brown |
| | N | = Bleu-Blauw-Blau-Blue |
| | ⏚ | = Vert/Jaune-Groen/Geel-Grün/Gelb-Green/Yellow |



L'installation doit être effectuée par un installateur qualifié.
 We raden aan om de installatie door een erkend vakman te laten doen.
 Die Installation durch einen Fachmann vornehmen lassen.
 Installation should be carried out by your local electrician.