



# WEU26/3-203A00

WSU/WEU26-3

**SAFETY SINGLE-BEAM SENSORS**

**SICK**  
Sensor Intelligence.



### Ordering information

Scanning range	System part	Type	Part no.
70 m	Receiver	WEU26/3-203A00	1048379

Other models and accessories → [www.sick.com/WSU\\_WEU26-3](http://www.sick.com/WSU_WEU26-3)



### Detailed technical data

#### Features

<b>Scanning range</b>	70 m
<b>Dimension of the light path</b>	15 m ... 70 m
<b>Number of beams</b>	1
<b>Detection capability</b>	30 mm
<b>Response time</b>	≤ 22 ms
<b>Front screen heating</b>	✓
<b>Synchronization</b>	Optical synchronisation

#### Safety-related parameters

<b>Type</b>	Type 4 (IEC 61496-1)
<b>Safety integrity level</b>	SIL 3 (IEC 61508)
<b>Category</b>	Category 4 (EN ISO 13849)
<b>Performance level</b>	PL e (EN ISO 13849)
<b>B<sub>10d</sub> parameter</b>	1 x 10 <sup>6</sup> switching cycles (AC-15, 230 V, 0.4 A), 2.6 x 10 <sup>5</sup> switching cycles (AC-15, 230 V, 2.0 A), 1 x 10 <sup>6</sup> switching cycles (DC-13, 24 V, 0.6 A), 2 x 10 <sup>5</sup> switching cycles (DC-13, 24 V, 1.5 A)
<b>PFH<sub>D</sub> (mean probability of a dangerous failure per hour)</b>	4.0 x 10 <sup>-9</sup> (EN ISO 13849)
<b>T<sub>M</sub> (mission time)</b>	20 years (EN ISO 13849)

#### Interfaces

<b>Connection type</b>	PG gland (13,5)
<b>Display elements</b>	LEDs

#### Electrical data

<b>Protection class</b>	I (EN 50178)
<b>Supply voltage V<sub>S</sub></b>	24 V DC (19.2 V DC ... 28.8 V DC)
<b>Power consumption</b>	≤ 8 W

<sup>1)</sup> Upon applying the supply voltage.

<b>Switch-on time</b>	$\leq 10 \text{ s}^{1)}$
<b>Switching outputs</b>	Relays
Usage category	AC-15/DC-13 (EN 60947-5-1)
Switching voltage	10 V DC ... 30 V DC 10 V AC ... 230 V AC
Current-carrying capacity per OSSD	0.02 A ... 2 A
Contact material	Ag alloy with Au coating
Electrical life (relay contacts)	$\geq 1 \times 10^5$ switching cycles
Mechanical life (relay contacts)	$\geq 1 \times 10^7$ switching cycles

<sup>1)</sup> Upon applying the supply voltage.

## Mechanical data

<b>Design</b>	Rectangular
<b>Dimensions (W x H x D)</b>	50 mm x 156 mm x 116 mm
<b>Housing material</b>	Aluminum die cast
<b>Front screen material</b>	Polycarbonate, scratch-resistant coating
<b>Weight</b>	$\leq 1 \text{ kg}$

## Ambient data

<b>Enclosure rating</b>	IP67 (EN 60529)
<b>Ambient operating temperature</b>	-25 °C ... +55 °C
<b>Storage temperature</b>	-25 °C ... +70 °C
<b>Air humidity</b>	15 % ... 95 %, Non-condensing
<b>Vibration resistance</b>	5 g, 10 Hz ... 55 Hz (IEC 60068-2-6)
<b>Shock resistance</b>	10 g, 16 ms (IEC 60068-2-29)

## Other information

<b>Wave length</b>	850 nm
--------------------	--------

## Classifications

<b>ECLASS 5.0</b>	27272701
<b>ECLASS 5.1.4</b>	27272701
<b>ECLASS 6.0</b>	27272701
<b>ECLASS 6.2</b>	27272701
<b>ECLASS 7.0</b>	27272701
<b>ECLASS 8.0</b>	27272701
<b>ECLASS 8.1</b>	27272701
<b>ECLASS 9.0</b>	27272701
<b>ECLASS 10.0</b>	27272701
<b>ECLASS 11.0</b>	27272701
<b>ECLASS 12.0</b>	27272701
<b>ETIM 5.0</b>	EC001831
<b>ETIM 6.0</b>	EC001831
<b>ETIM 7.0</b>	EC001831



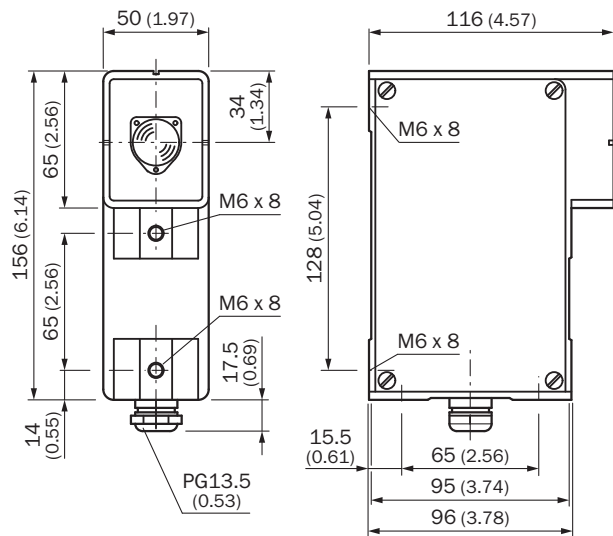

<b>ETIM 8.0</b>	EC001831
<b>UNSPSC 16.0901</b>	46171620





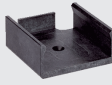

### Dimensional drawing (Dimensions in mm (inch))



### Recommended accessories

Other models and accessories → [www.sick.com/WSU\\_WEU26-3](http://www.sick.com/WSU_WEU26-3)

Brief description	Type	Part no.
<b>Reduction and extension pieces</b>		
Adapter for cable entry from PG 13 to PG 21	PG extension for PG13 to PG21	5306052
<b>Alignment aids</b>		
	AR60	1015741
	AR60 adapter, WSU/WEU26	4031156
<b>Deflector mirrors</b>		
	PNS75-008	1026647
	PSK1	1005229
	PSK45	5306053

	Brief description	Type	Part no.
Test and monitoring tools			
		Test rod 30 mm	2022602
Distributors			
	<ul style="list-style-type: none"> <li>• <b>Description:</b> PG expansion with 2 cable entries PG21</li> </ul>	Two-way splitter	5305978
Mounting brackets and plates			
		BEF-4WNAEFAL1	2007900
		BEF-4AAAAHST3	2012473

## SICK AT A GLANCE

SICK is one of the leading manufacturers of intelligent sensors and sensor solutions for industrial applications. A unique range of products and services creates the perfect basis for controlling processes securely and efficiently, protecting individuals from accidents and preventing damage to the environment.

We have extensive experience in a wide range of industries and understand their processes and requirements. With intelligent sensors, we can deliver exactly what our customers need. In application centers in Europe, Asia and North America, system solutions are tested and optimized in accordance with customer specifications. All this makes us a reliable supplier and development partner.

Comprehensive services complete our offering: SICK LifeTime Services provide support throughout the machine life cycle and ensure safety and productivity.

For us, that is “Sensor Intelligence.”

## WORLDWIDE PRESENCE:

Contacts and other locations –[www.sick.com](http://www.sick.com)