



Product designation
Product type designation

Power contactor
BGF09

Contact characteristics

Number of poles	Nr.	4
Rated insulation voltage U_i IEC/EN	V	690
Rated impulse withstand voltage U_{imp}	kV	6
Operational frequency	min	Hz 25
	max	Hz 400
IEC Conventional free air thermal current I_{th}	A	20
Operational current I_e	AC-1 ($\leq 40^\circ\text{C}$)	A 20
	AC-1 ($\leq 55^\circ\text{C}$)	A 18
	AC-1 ($\leq 70^\circ\text{C}$)	A 15
	AC-3 ($\leq 440\text{V} \leq 55^\circ\text{C}$)	A 9
	AC-4 (400V)	A 4
Rated operational power AC-1 ($T \leq 40^\circ\text{C}$)	230V	kW 8
	400V	kW 14
	500V	kW 16
	690V	kW 22
IEC max current I_e in DC1 with $L/R \leq 1\text{ms}$ with 1 poles in series	$\leq 24\text{V}$	A 12
	48V	A 10
	75V	A 4
	110V	A 3
	220V	A –
IEC max current I_e in DC1 with $L/R \leq 1\text{ms}$ with 2 poles in series	$\leq 24\text{V}$	A 15
	48V	A 14
	75V	A 9
	110V	A 8
	220V	A –
IEC max current I_e in DC1 with $L/R \leq 1\text{ms}$ with 3 poles in series	$\leq 24\text{V}$	A 16
	48V	A 16
	75V	A 10
	110V	A 10
	220V	A 2
IEC max current I_e in DC1 with $L/R \leq 1\text{ms}$ with 4 poles in series	$\leq 24\text{V}$	A 16
	48V	A 16
	75V	A 10
	110V	A 10
	220V	A 2
IEC max current I_e in DC3-DC5 with $L/R \leq 15\text{ms}$ with 1 poles in series		

	≤24V	A	7
	48V	A	6
	75V	A	2
	110V	A	1
	220V	A	–
<hr/>			
IEC max current I _e in DC3-DC5 with L/R ≤ 15ms with 2 poles in series	≤24V	A	8
	48V	A	8
	75V	A	5
	110V	A	4
	220V	A	–
<hr/>			
IEC max current I _e in DC3-DC5 with L/R ≤ 15ms with 3 poles in series	≤24V	A	10
	48V	A	10
	75V	A	6
	110V	A	5
	220V	A	0,8
<hr/>			
IEC max current I _e in DC3-DC5 with L/R ≤ 15ms with 4 poles in series	≤24V	A	10
	48V	A	10
	75V	A	6
	110V	A	5
	220V	A	0,8
<hr/>			
Short-time allowable current for 10s (IEC/EN60947-1)		A	96
<hr/>			
Protection fuse			
	gG (IEC)	A	20
	aM (IEC)	A	10
<hr/>			
Making capacity (RMS value)		A	92
<hr/>			
Breaking capacity at voltage			
	440V	A	72
	500V	A	72
	690V	A	72
<hr/>			
Resistance per pole (average value)		mΩ	10
<hr/>			
Power dissipation per pole (average value)			
	I _{th}	W	4
	AC-3	W	0.81
<hr/>			
Tightening torque for terminals			
	min	Nm	0.8
	max	Nm	1
	min	lbin	9
	max	lbin	9
<hr/>			
Tightening torque for coil terminal			
	min	Nm	0.8
	max	Nm	1
	min	lbin	9
	max	lbin	9
<hr/>			
Max number of wires simultaneously connectable		Nr.	2
<hr/>			
Conductor section			
	AWG/Kcmil		
	max		12
<hr/>			
	Flexible w/o lug conductor section		
	min	mm ²	0.75
	max	mm ²	2.5

Flexible c/w lug conductor section			
	min	mm ²	1.5
	max	mm ²	2.5
Flexible with insulated spade lug conductor section			
	min	mm ²	1.5
	max	mm ²	2.5
Power terminal protection according to IEC/EN 60529			IP20 when properly wired
Mechanical features			
Operating position			
	normal allowable		Vertical plan ±30°
Fixing			Screw / DIN rail 35mm
Weight			g 210
Conductor section			
AWG/kcmil conductor section			
	max		12
Auxiliary contact characteristics			
Thermal current I _{th}			A 10
IEC/EN 60947-5-1 designation			Q600
Operations			
Mechanical life			cycles 20000000
Electrical life			cycles 500000
Safety related data			
Performance level B10d according to EN/ISO 13489-1			
	rated load	cycles	500000
	mechanical load	cycles	20000000
Mirror contacts according to IEC/EN 60947-4-1			yes
EMC compatibility			yes
DC coil operating			
DC rated control voltage			V 60
DC operating voltage			
pick-up			
	min	%Us	75
	max	%Us	115
drop-out			
	min	%Us	10
	max	%Us	25
Average coil consumption ≤20°C			
	in-rush	W	3.2
	holding	W	3.2
Max cycles frequency			
Mechanical operation			cycles/h 3600
Operating times			
Average time for U _s control in AC			
Closing NO			
	min	ms	12
	max	ms	21
Opening NO			
	min	ms	9
	max	ms	18
Closing NC			

		min	ms	17
		max	ms	26
	Opening NC			
		min	ms	7
		max	ms	17
<hr/>				
in DC				
	Closing NO			
		min	ms	18
		max	ms	25
	Opening NO			
		min	ms	2
		max	ms	3
	Closing NC			
		min	ms	3
		max	ms	5
	Opening NC			
		min	ms	11
		max	ms	17

UL technical data

Full-load current (FLA) for three-phase AC motor

at 480V	A	7.6
at 600V	A	6.1

Yielded mechanical performance

for single-phase AC motor

110/120V	HP	0.5
230V	HP	1.5

for three-phase AC motor

200/208V	HP	2
220/230V	HP	3
460/480V	HP	5
575/600V	HP	5

General USE

Contactor

AC current	A	20
------------	---	----

Short-circuit protection fuse, 600V

High fault

Short circuit current	kA	100
Fuse rating	A	30
Fuse class		J

Standard fault

Short circuit current	kA	5
Fuse rating	A	30

Ambient conditions

Temperature

Operating temperature

min	°C	-50
max	°C	+70

Storage temperature

min	°C	-60
max	°C	+80

Max altitude

m	3000
---	------

Resistance & Protection

Pollution degree

3

Dimensions

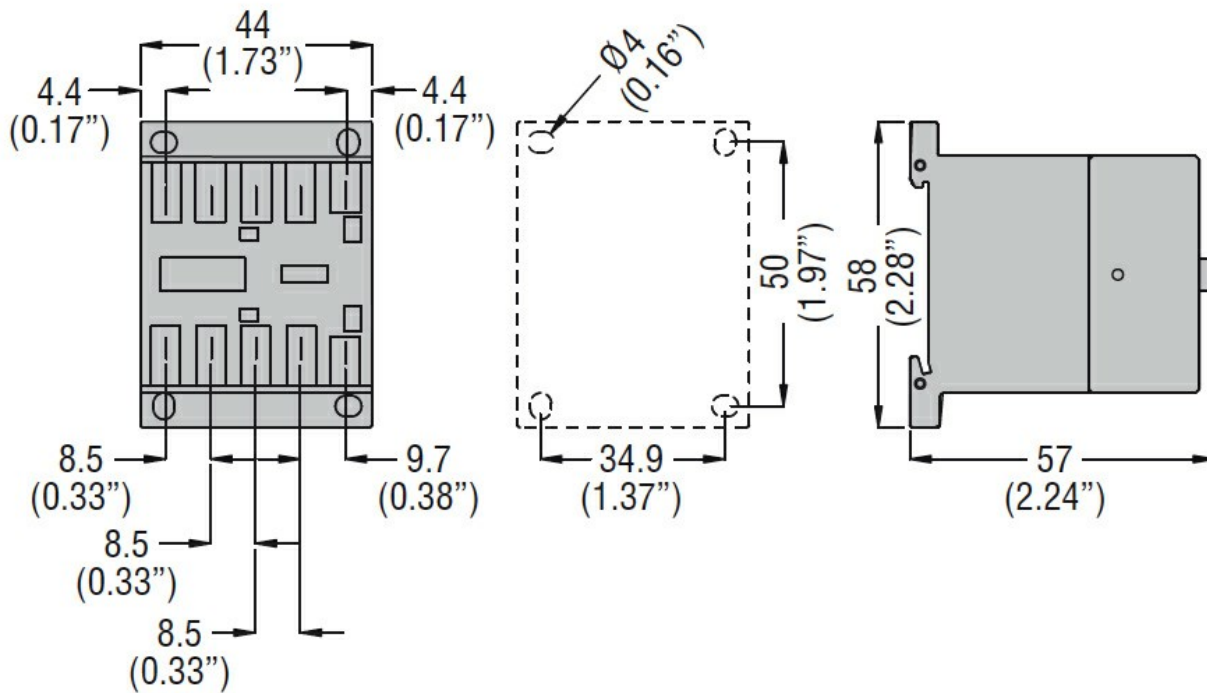

Wiring diagrams

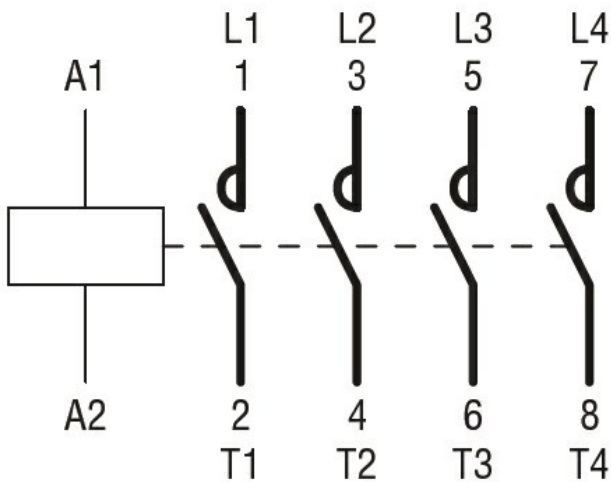

Certifications and compliance

Compliance

CSA C22.2 n° 60947-1
 CSA C22.2 n° 60947-4-1
 IEC/EN 60947-1
 IEC/EN 60947-4-1
 UL 60947-1
 UL 60947-4-1

Certificates

CCC
 cULus
 EAC

ETIM classification

ETIM 8.0

EC000066 -
 Power contactor,
 AC switching