



LMS4111R-13000

LMS4000

2D LIDAR SENSORS

SICK
Sensor Intelligence.

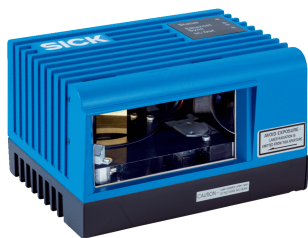

Ordering information

Type	Part no.
LMS4111R-13000	1091423

Other models and accessories → www.sick.com/LMS4000



Detailed technical data

Features

Application	Indoor
Reading field	Front
Light source	Visible red light (660 nm)
Laser class	2 (IEC 60825-1:2014, EN 60825-1:2014)
Aperture angle	Horizontal 70°
Scanning frequency	600 Hz
Angular resolution	0.0833°
Working range	0.7 m ... 3 m
Scanning range	At 2% remission 2.3 m At 3,5% remission 3 m At 10% remission factor 3 m

Mechanics/electronics

Connection type	1 x M12, 5-pin plug (Power + I/O + Sync) 1 x M12, 8-pin female connector (Ethernet) 1 x M12, 5-pin female connector (Encoder + I/O)
Supply voltage	24 V DC, ± 25 %
Power consumption	≤ 16 W, start-up phase max. 29 W
Output current	≤ 100 mA
Housing	Aluminum die cast
Housing color	Light blue (RAL 5012)
Enclosure rating	IP65
Protection class	III
Electrical safety	IEC 61010-1:2011
Weight	2.4 kg
Dimensions (L x W x H)	192 mm x 130 mm x 107 mm
MTBF	80 years

Safety-related parameters

MTTF_D	> 100 years
-------------------------	-------------

Performance

Scan/frame rate	504,600 measurement point/s
Response time	≥ 4.8 ms
Detectable object shape	Almost any
Systematic error	± 1.5 mm ¹⁾
Statistical error	2.5 mm ¹⁾
Integrated application	Data output
Filter	Rectangular filter Edge filter Median filter Gloss compensation Average filter

¹⁾ Typical value; actual value depends on environmental conditions.

Interfaces

Ethernet	✓, TCP/IP, UDP/IP
Function	Measurement data output (distance, RSSI, angle)
Data transmission rate	100 Mbit/s ... 1,000 Mbit/s, half/full-duplex
Digital inputs	2
Encoder inputs	2 (phase A, phase B)
Digital outputs	3
Synchronization inputs/outputs	One (master / slave)
Optical indicators	4 LEDs
Configuration software	SOPAS ET
Maximum encoder frequency	50 kHz

Ambient data

Object remission	3.5 % ... 300 %
Electromagnetic compatibility (EMC)	EN 61000-6-3:2007+A1:2011, IEC 61000-6-3:2006+AMD1:2010
Vibration resistance	EN 60068-2-6:2007
Shock resistance	EN 60068-2-27:2008
Ambient operating temperature	-10 °C ... +50 °C ¹⁾
Storage temperature	-20 °C ... +70 °C
Permissible relative humidity	≤ 90 %, Non-condensing
Ambient light immunity	2,000 lx

¹⁾ Initialization phase: 0 °C ... 50 °C.

General notes

Note on use	The sensor does not constitute a safety component as defined by relevant legislation on machine safety.
--------------------	---------------------------------------------------------------------------------------------------------

Classifications

ECLASS 5.0	27270990
ECLASS 5.1.4	27270990

ECLASS 6.0	27270913
ECLASS 6.2	27270913
ECLASS 7.0	27270913
ECLASS 8.0	27270913
ECLASS 8.1	27270913
ECLASS 9.0	27270913
ECLASS 10.0	27270913
ECLASS 11.0	27270913
ECLASS 12.0	27270913
ETIM 5.0	EC002550
ETIM 6.0	EC002550
ETIM 7.0	EC002550
ETIM 8.0	EC002550
UNSPSC 16.0901	41111615

Dimensional drawing (Dimensions in mm (inch))

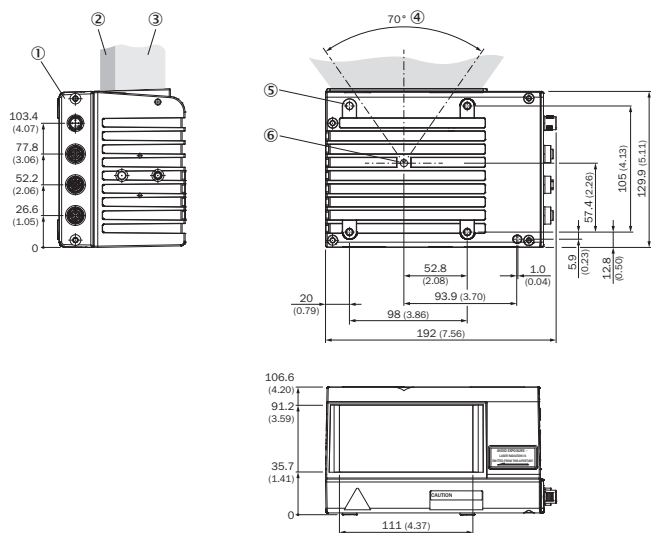

- ① Interfaces, types and number can vary
- ② Sending area
- ③ Receiving area
- ④ Aperture angle
- ⑤ Reference boreholes
- ⑥ Distance measurement zero point

Working range diagram

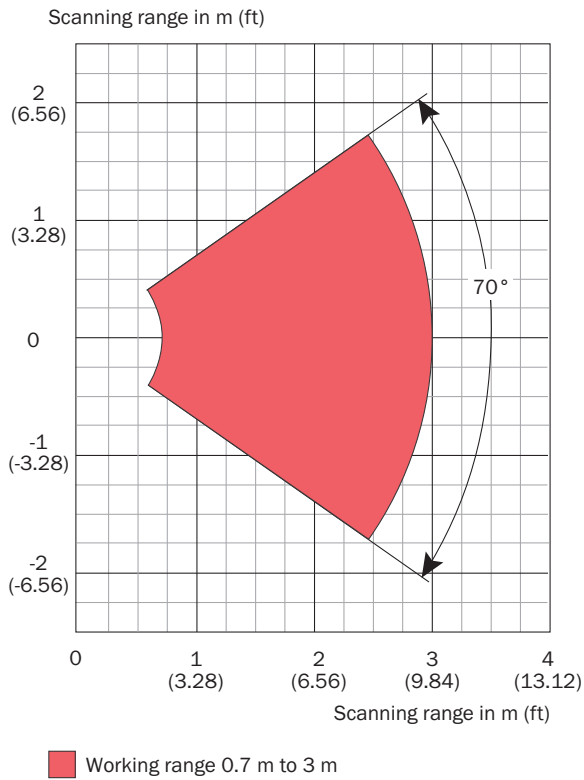

Connection type

Gigabit Ethernet

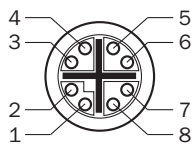

M12, 8-pin female connector, X-coded (Gigabit Ethernet)

- ① TRD0_P
- ② TRD0_N
- ③ TRD1_P
- ④ TRD1_N
- ⑤ TRD3_P
- ⑥ TRD3_N
- ⑦ TRD2_P
- ⑧ TRD2_N

PIN assignment

Encoders

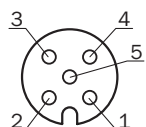

Female connector M12, 5-pin, A-coded

- ① 24 V DC ± 25 %
- ② Encoders B
- ③ GND
- ④ Encoders A
- ⑤ IN1/OUT1

Power

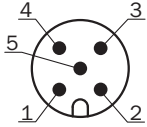







Connector M12, 5-pin, A-coded

- ① 24 V DC ± 25 %
- ② SYNC
- ③ GND
- ④ IN2/OUT2
- ⑤ OUT4

Recommended accessories

Other models and accessories → www.sick.com/LMS4000

	Brief description	Type	Part no.
Plug connectors and cables			
	<ul style="list-style-type: none"> • Connection type head A: Male connector, M12, 8-pin, straight, X-coded • Connection type head B: Male connector, RJ45, 8-pin, straight • Signal type: Ethernet, Gigabit Ethernet • Cable: 5 m, 8-wire, PUR, halogen-free • Description: Ethernet, Gigabit Ethernet, shielded • Application: Zones with oils and lubricants 	YM2X18-050EG1MRJA8	2106259
Terminal and alignment brackets			
	Holder for Item Profile	Alignment bracket	2030421
Others			
	<ul style="list-style-type: none"> • Connection type head A: Female connector, M12, 5-pin, straight, A-coded • Connection type head B: Male connector, M12, 5-pin, straight, A-coded • Signal type: Sensor/actuator cable • Cable: 5 m, 5-wire, PUR, halogen-free • Description: Sensor/actuator cable, shielded • Application: Zones with oils and lubricants, Drag chain operation 	YF2A85-050UB6M2A85	2096119
	<ul style="list-style-type: none"> • Connection type head A: Female connector, M12, 5-pin, straight, A-coded • Connection type head B: Flying leads • Signal type: Sensor/actuator cable • Cable: 5 m, 5-wire, PUR, halogen-free • Description: Sensor/actuator cable, shielded • Application: Zones with oils and lubricants, Drag chain operation, Robot 	YF2A25-050UB6XLEAX	2095733
		PS50W-24V	7028789

	Brief description	Type	Part no.
Measuring wheel encoders			
	<ul style="list-style-type: none"> • Measuring wheel circumference: 300 mm • Measuring wheel surface: O-ring NBR70 • Communication interface: 10 V ... 32 V, Incremental, HTL, Push pull • Supply voltage: 10 V ... 32 V • Connection type: Male connector, M12, 5-pin, radial • Resolution in pulses/mm: 5 • Specialty: M12 male connector, 5-pin 	DFV60B-22EZ0-S03	1051292

Recommended services

Additional services → www.sick.com/LMS4000

	Type	Part no.
Maintenance		
<ul style="list-style-type: none"> • Product area: 2D LiDAR sensors, 3D LiDAR sensors • Range of services: Inspection, analysis and restoring of defined functions, Inspection and adaptation of basic settings, parameters of field application, filters for raw data output, and product-specific configuration • Duration: Additional work will be invoiced separately • Travel expenses: The prices do not include travel costs such as hotel, flight, travel time and expenses. 	Maintenance of LiDAR sensors	1682593
Commissioning		
<ul style="list-style-type: none"> • Product area: 2D LiDAR sensors, 3D LiDAR sensors • Range of services: Inspection of connection, fine adjustment, configuration of monitored areas, configuration and optimization of parameters as well as tests, Setup of previously defined functions of basic settings, parameters of field application, filters for raw data output and product-specific configuration • Travel expenses: The prices do not include travel costs such as hotel, flight, travel time and expenses. • Duration: Additional work will be invoiced separately 	Commissioning LiDAR sensors	1680672
Extended warranty		
<ul style="list-style-type: none"> • Product area: Identification solutions, machine vision, Detection and ranging solutions, safety camera sensors, Safety laser scanners, Safety radar sensors • Range of services: The services correspond to the scope of the statutory manufacturer warranty (SICK general terms of delivery). • Duration: Five-year warranty from delivery date. 	Extended warranty for a total of five years from delivery date	1680671
Service agreements		
<ul style="list-style-type: none"> • Product area: Robot guidance systems, Track and trace systems, Driver assistance systems, Object detection systems, Profiling systems, Gateway systems, Quality control systems • Range of services: Maintenance, Troubleshooting, extended warranty, 8/5 remote support, 8/5 help desk • Duration: Duration is arranged individually with the customer and defined in the contract 	Bronze service agreements for Systems	1616164

SICK AT A GLANCE

SICK is one of the leading manufacturers of intelligent sensors and sensor solutions for industrial applications. A unique range of products and services creates the perfect basis for controlling processes securely and efficiently, protecting individuals from accidents and preventing damage to the environment.

We have extensive experience in a wide range of industries and understand their processes and requirements. With intelligent sensors, we can deliver exactly what our customers need. In application centers in Europe, Asia and North America, system solutions are tested and optimized in accordance with customer specifications. All this makes us a reliable supplier and development partner.

Comprehensive services complete our offering: SICK LifeTime Services provide support throughout the machine life cycle and ensure safety and productivity.

For us, that is “Sensor Intelligence.”

WORLDWIDE PRESENCE:

Contacts and other locations –www.sick.com