



Product designation				Enclosed switch disconnecter
Product type designation				GLZM
Number of poles	Nr.			3
Operating voltage type				AC
Contact characteristics				
IEC Conventional free air thermal current I _{th}	A			250
Rated insulation voltage U _i IEC/EN	V			1000
Rated impulse withstand voltage U _{imp}	kV			12
Operating current I _e				
AC21A	400V	A	250	
	500V	A	250	
	690V	A	250	
AC22A	400V	A	250	
	500V	A	250	
	690V	A	250	
AC23A	400V	A	250	
	500V	A	250	
	690V	A	250	
Power dissipation per pole max	W			6.5
Rated operational power AC23A	400V	kW	140	
	690V	kW	250	
Conditional short-circuit current (rms)	kA			100
Short-circuit protection with fuse	Class/A			gG/250
Making capacity AC23A 400V	A			2500
Breaking capacity AC23A 400V	A			2000
Mechanical life	cycles			10000
Mechanical features				
Operating position	normal allowable			Vertical plan Any
Terminals	type			M8 x 25
Tightening torque for terminals	min	Nm	15	
	max	Nm	22	
	min	lbin	132	
	max	lbin	194	
Conductor section	IEC min	mm ²	70	
	IEC max	mm ²	185	

AWG/kcmil min	00
AWG/kcmil max	400

Ambient conditions

Operating temperature

min	°C	-25
max	°C	+55

Storage temperature

min	°C	-40
max	°C	+70

Max altitude

m	3000
---	------

Resistance & Protection

Frontal IP degree

IP65

IP degree of protection

IP65

Pollution degree

3

Dimensions

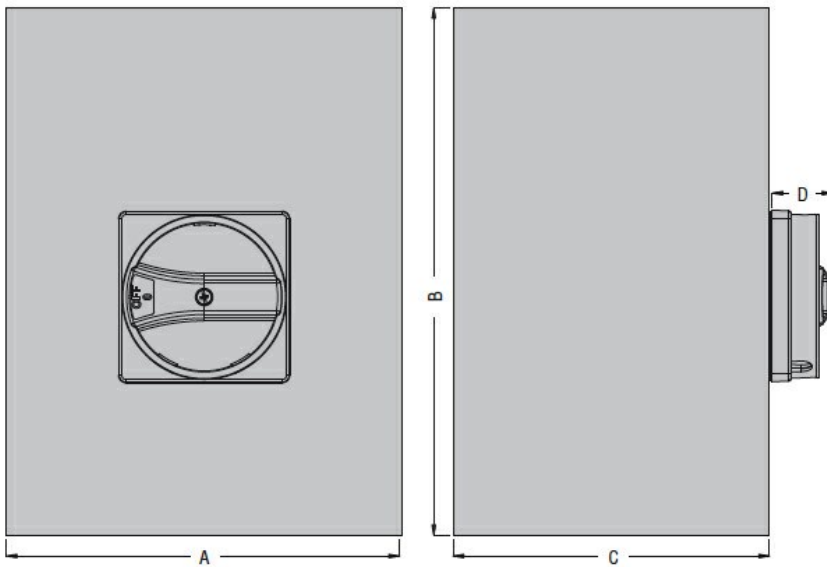

Type	A	B	C	D
GLZM0160...GLZM0315...	300 (11.81")	400 (15.75")	250 (9.84")	45,7 (1.80")

Wiring diagrams

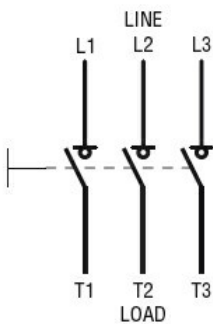

Certifications and compliance

Compliance

IEC/EN 60947-1
IEC/EN 60947-3

ETIM classification

ETIM 8.0

EC000216 -
Switch
disconnector