



Product designation	Hinge operating		
Product type designation	KMP		
General characteristics			
General characteristics			
Housing Material	Aluminium-zinc alloy		
Rod material	Long solid		
Contact characteristics			
Type of contact	1NO+2NC Slow action		
Thermal current I _{th}	A	10	
IEC/EN 60947-5-1 designation	A300 Q300		
Rated insulation voltage U _i	V	440	
Rated impulse withstand voltage U _{imp}	kV	4	
Short-circuit protection with fuse	Class/A	10 gG/SC QUICK FUSE	
Switching speed	min	m/s	0.5
	max	m/s	1.5
IEC Conventional free air thermal current I _{th}	A	10	
Resistance per pole (average value)	mΩ	<10	
Operations			
Mechanical life	cycles	100000	
B10d	cycles	100000	
Mechanical operation	cycles/h	3600	
Output characteristics			
Mechanical life	cycles	100000	
Mechanical features			
Operating head fixing	Locking bayonet insert		
Operating torque	Ncm	15	
	ozin	21.2	
Tightening torque (Max)			
Switch fixing	Nm	2.5	
	lbin	22.1	
Contact terminals	Nm	0.8	
	lbin	7	
Body lid screw fixing	Nm	0.8	
	lbin	7	
Conductor section	AWG/Kcmil		

LIMIT SWITCH, K SERIES, HINGE OPERATING, 1 BOTTOM CABLE ENTRY. DIMENSIONS TO EN 50047, METAL BODY, CONTACTS 1NO+2NC SLOW ACTION. LONG SOLID SHAFT

	min	16	
	max	14	
IEC			
	min	mm ²	1 or 2
	max	mm ²	2.5
Cable connection	Self-releasing screw terminal		
Cable entry	M20 on the bottom		
Ambient conditions			
Pollution degree	3		
Temperature			
Operating temperature			
	min	°C	-25
	max	°C	+70
Storage temperature			
	min	°C	-40
	max	°C	+70

Dimensions

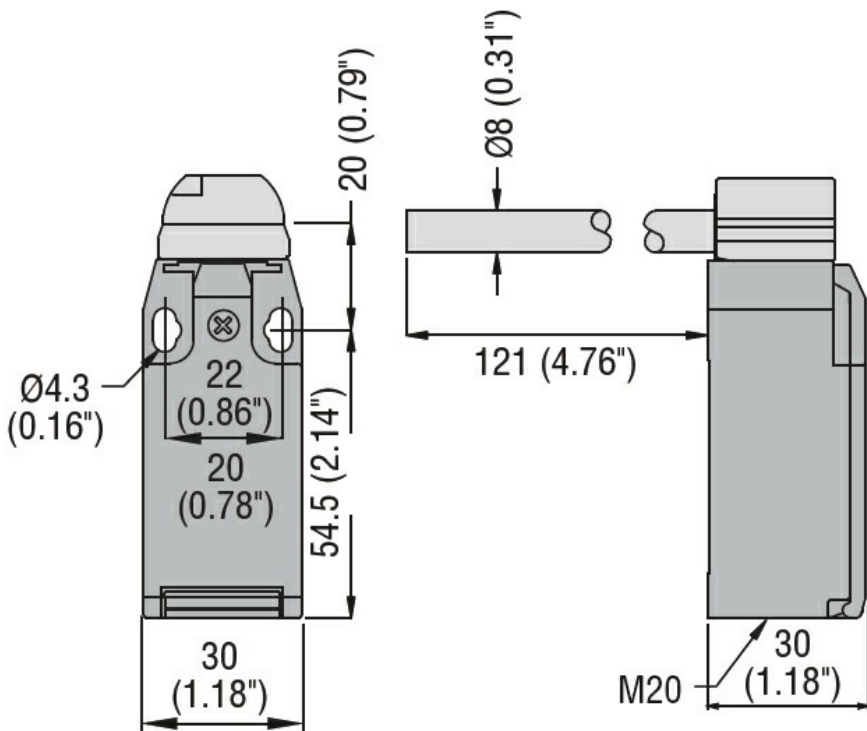

Wiring diagrams

Slow action

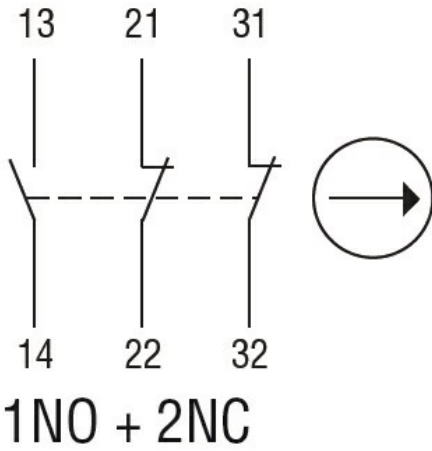

Certifications and compliance

Compliance

CSA C22.2 n° 14

EN 50047

IEC/EN 60204-1

IEC/EN 60947-1

IEC/EN 60947-5-1

UL508

Certificates

CCC

cULus

EAC

ETIM classification

ETIM 8.0

EC000030 - End switch