

THIS COPY IS PROVIDED ON A RESTRICTED BASIS AND IS NOT TO BE USED IN ANY WAY DETRIMENTAL TO THE INTERESTS OF PANDUIT CORP.

- NOTES:
1. SHEET 1 - LENGTHS LESS THAN OR EQUAL TO 100ft. (30m)
  2. WEIGHT: 63 lbs (28.6kg) WITH 100 FT. OF CABLE
  3. 1 ENCLOSURE AND CABLE WILL BE PACKAGED WITHIN BOX UP TO 100 FT (30m).
  4. 3 BOXES CAN BE STACKED ON 1 PALLET.
  5. PART NUMBER MATRIX SHOWN ON SHEET 4.
  6. VIEW ONLINE INFORMATION FOR FDFUE4GY FOR INQUIRIES ABOUT ENCLOSURE.
  7. VISIT OUR ON-LINE CATALOG AT WWW.PANDUIT.COM FOR A LIST OF CURRENT PARTS APPLICABLE FOR USE WITH THIS PRODUCT.
  8. DIMENSIONS IN ( ) ARE METRIC.
  9. ALL MATERIALS AND COMPONENTS USED MEET THE MATERIAL RESTRICTIONS OF RoHS (EUROPEAN DIRECTIVE 2011/65/EU ON THE RESTRICTION OF HAZARDOUS SUBSTANCES) AS PROPOSED BY THE RoHS TECHNICAL ADAPTATION COMMITTEE.

TETHERED LEFT

TETHERED LEFT TRAY LABEL FORMAT (12 TRAYS)

FLEXCORE 4RU ODF ENCLOSURE (FDFUE4GY)

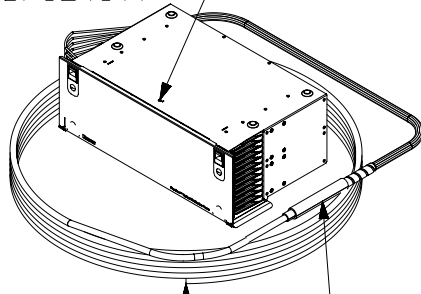
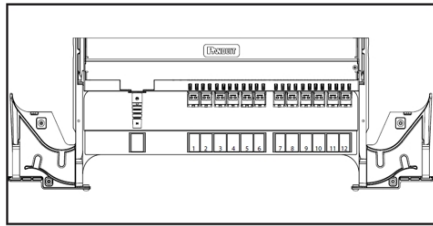

PULLING EYE NOT SHOWN, AVAILABLE ON BLUNT END

O.D. OF CABLE TRANSITION = 0.875" (22.5mm)

TETHERED RIGHT

TETHERED RIGHT TRAY LABEL FORMAT (12 TRAYS)

FLEXCORE 4RU ODF ENCLOSURE (FDFUE4GY)

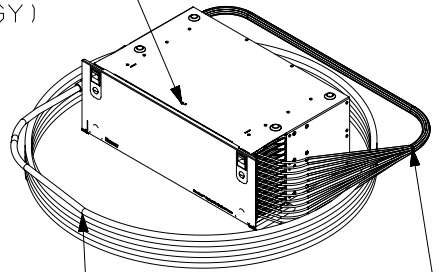
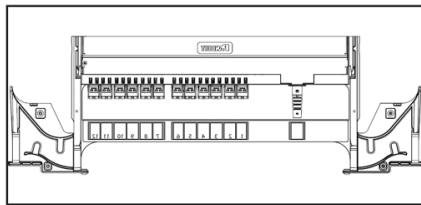

O.D. OF CABLE = 0.49" (12.5mm)

30" (762mm) BREAKOUT LENGTH FROM CABLE TRANSITION TO ENTRANCE OF CASSETTE

TRAYS LABELS INSTALLED  
12 - TOP ROW  
1 - BOTTOM ROW

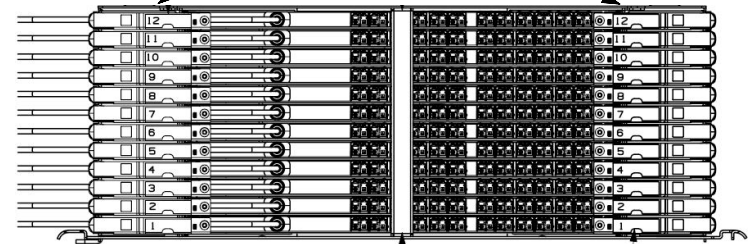

PART NUMBER		F8BNM**BNS*****		
TITLE				
288 Fiber Tethered FlexCore ODF Enclosure Tethered Left or Right to Blunt End [Less than or Equal to 100ft. (30m)]				
CUSTOMER DRAWING				
ITEM REVISION NAME		01171EAK/01		
DATASET FILE NAME		01171EAK_DC/01A		
MATERIAL		N/A		
DRAWN BY		DATE	CHK	SCALE
SAT		09/21/22	BJBE	NONE
DRAWING NUMBER		01171EAK-DC		
SHEET 1 OF 4		A		

A-SIZE CUSTOMER

01A	3-30-22	SAT	BJBE	EJH	ADDED LENGTHS UP TO 240 FT. (73m) (SHEET 2)	01171EAK-DC
00A	11-28-22	SAT	BJBE	EJH	INITIAL RELEASE	01171EAK-DC
REV	DATE	BY	CHK	APR	DESCRIPTION	ECN

THIS COPY IS PROVIDED ON A RESTRICTED BASIS AND IS NOT TO BE USED IN ANY WAY DETRIMENTAL TO THE INTERESTS OF PANDUIT CORP.

TETHERED LEFT TRAY LABEL FORMAT (12 TRAYS)

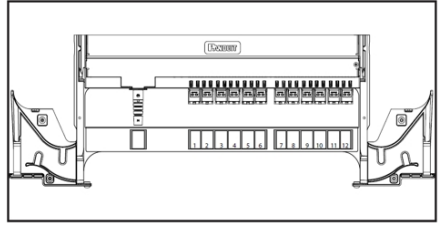

TETHERED LEFT

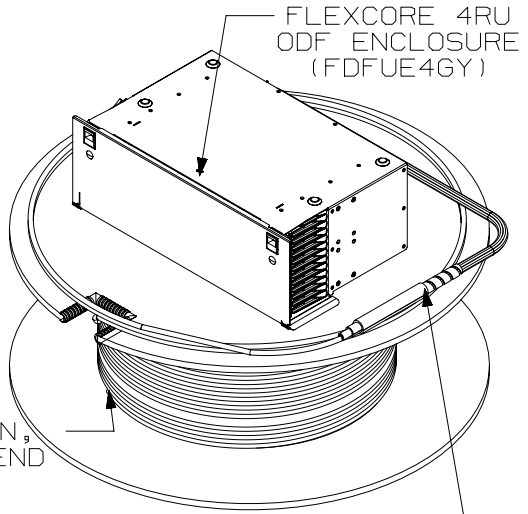

PULLING EYE NOT SHOWN, AVAILABLE ON BLUNT END

O.D. OF CABLE TRANSITION = 0.875" (22.5mm)

TETHERED RIGHT

TETHERED RIGHT TRAY LABEL FORMAT (12 TRAYS)

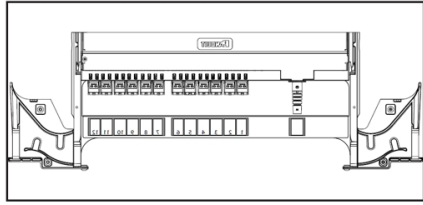

FLEXCORE 4RU ODF ENCLOSURE (FDFUE4GY)

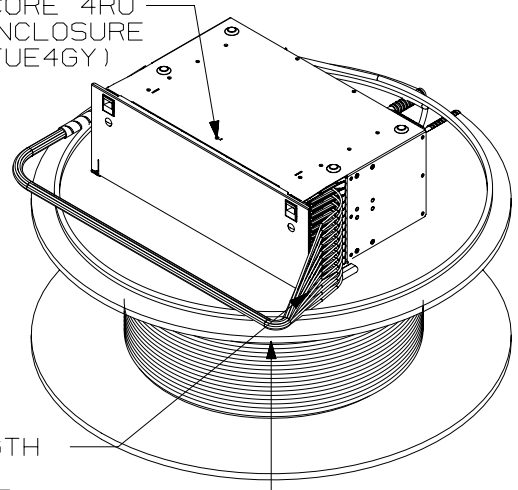

30" (762mm) BREAKOUT LENGTH FROM CABLE TRANSITION TO ENTRANCE OF CASSETTE

O.D. OF CABLE = 0.49" (12.5mm)

NOTES:

1. SHEET 2 - LENGTHS FROM 101ft (31m) TO 240ft (73m)
2. WEIGHT: 93 lbs (42.2kg) WITH 150 FT. OF CABLE AND SPOOL
3. 1 ENCLOSURE AND CABLE WILL BE PACKAGED ON TOP OF SPOOL
4. 1 SPOOL PER PALLET
5. PART NUMBER MATRIX SHOWN ON SHEET 4.
6. VIEW ONLINE INFORMATION FOR FDFUE4GY FOR INQUIRIES ABOUT ENCLOSURE.
7. VISIT OUR ON-LINE CATALOG AT WWW.PANDUIT.COM FOR A LIST OF CURRENT PARTS APPLICABLE FOR USE WITH THIS PRODUCT.
8. DIMENSIONS IN ( ) ARE METRIC.
9. ALL MATERIALS AND COMPONENTS USED MEET THE MATERIAL RESTRICTIONS OF RoHS (EUROPEAN DIRECTIVE 2011/65/EU ON THE RESTRICTION OF HAZARDOUS SUBSTANCES) AS PROPOSED BY THE RoHS TECHNICAL ADAPTATION COMMITTEE.

TRAYS LABELS INSTALLED  
12 - TOP ROW  
1 - BOTTOM ROW

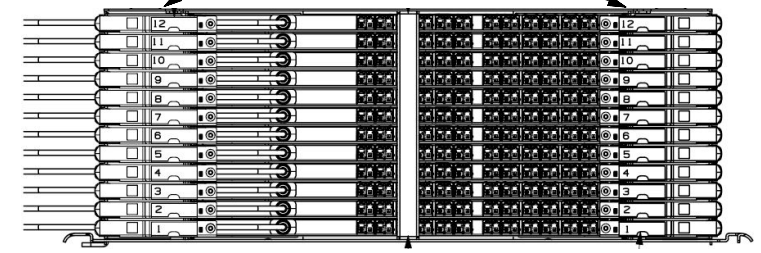

PART NUMBER		F8BNM**BNS*****		
TITLE				
288 Fiber Tethered FlexCore ODF Enclosure Tethered Left or Right to Blunt End [From 101ft. (31m) to 240ft. (73m)]				
CUSTOMER DRAWING				
ITEM REVISION NAME		01171EAK/01		
DATASET FILE NAME		01171EAK_DC/01A		
MATERIAL		N/A		
DRAWN BY		DATE	CHK	SCALE
SAT		09/21/22	BJBE	NONE
DRAWING NUMBER		01171EAK-DC		
REV		DATE	BY	CHK
SEE SHEET 1 FOR REVISION HISTORY		DESCRIPTION		
ECN		SHEET 2 OF 4		
A-SIZE CUSTOMER		A		

THIS COPY IS PROVIDED ON A RESTRICTED BASIS AND IS NOT TO BE USED IN ANY WAY DETRIMENTAL TO THE INTERESTS OF PANDUIT CORP.

TETHERED LEFT SHOWN BELOW  
SAME LABELING AS TETHERED RIGHT

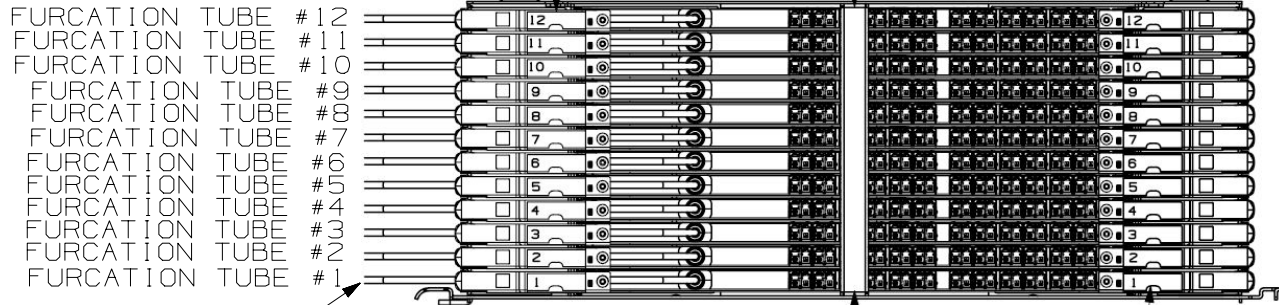

FURCATION TUBE LABEL ON CABLE (1 EACH TUBE)

FURCATION TUBE #	ROW ON ENCLOSURE	RIBBONS INSIDE CASSETTE	SYMBOLS ON FLEXIBLE RIBBON ON BLUNT END
1	1	1	
		2	
2	2	3	
		4	
3	3	5	□
		6	□
4	4	7	□
		8	□
5	5	9	□
		10	□ □
6	6	11	□ □
		12	□ □
7	7	13	□ □
		14	□ □
8	8	15	□ □ □
		16	□ □ □
9	9	17	□ □ □
		18	□ □ □
10	10	19	□ □ □
		20	□ □ □ □
11	11	21	□ □ □ □
		22	□ □ □ □
12	12	23	□ □ □ □
		24	□ □ □ □

LEFT TETHERED STANDARD POLARITY

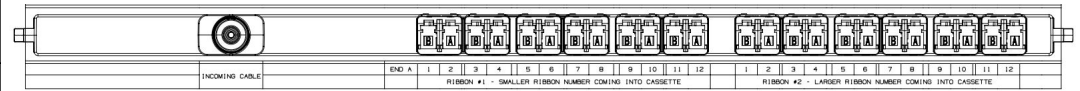

RIGHT TETHERED STANDARD POLARITY

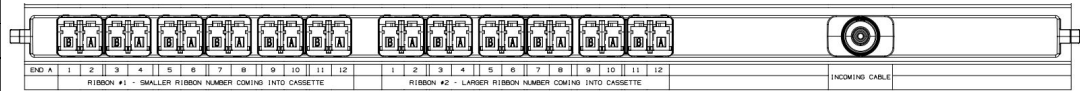

FIBER COLOR KEY	
FIBER 1 - BLUE	FIBER 7 - RED
FIBER 2 - ORANGE	FIBER 8 - BLACK
FIBER 3 - GREEN	FIBER 9 - YELLOW
FIBER 4 - BROWN	FIBER 10 - VIOLET
FIBER 5 - SLATE	FIBER 11 - ROSE
FIBER 6 - WHITE	FIBER 12 - AQUA

PART NUMBER  
**F8BNM\*\*BNS\*\*\*\***

TITLE  
**288 Fiber Tethered FlexCore ODF Enclosure  
Tethered Left or Right to Blunt End  
[All Lengths up to 240ft. (73m)]**

CUSTOMER DRAWING

ITEM REVISION NAME  
01171EAK/01

DATASET FILE NAME  
01171EAK\_DC/01A

MATERIAL  
N/A

DRAWING NUMBER  
01171EAK-DC

THIRD ANGLE PROJECTION

REV | DATE | BY | CHK | APR | DESCRIPTION | ECN | DRAWN BY | DATE | CHK | SCALE | SHEET 3 OF 4 | SIZE

SAT | 09/21/22 | BJB | NONE | A

SEE SHEET 1 FOR REVISION HISTORY

DESCRIPTION

ECN

DRAWN BY

SAT

DATE

09/21/22

CHK

BJBE

SCALE

NONE

DRAWING NUMBER

01171EAK-DC

SHEET 3 OF 4

SIZE

A

FINISHED GOOD PART NUMBER MATRIX														
1	2	3	4	5	6	7	8	9	10	11	12	13	14	15
F	8	B	N	M	*	*	B	N	S	*	*	*	*	*
											LENGTH: 005 TO 073 M. 015 TO 240 FT.			
											LENGTH: F = FEET M = METERS			
											PULLING EYE: A = PULLING EYE ON BLUNT END N = NO PULLING EYE			
											POLARITY/PERFORMANCE: S = STANDARD PERFORMANCE/STANDARD POLARITY			
											TRANSITION AND CONNECTOR ON OTHER END: N = NONE (PIGTAIL OPTION ONLY)			
											TRANSITION DISTANCE (ONLY ON 1 END): B = 30" EQUAL BREAKOUT FOR TETHERED CASSETTES			
											TETHERED CASSETTE OPTION (ONLY ON 1 END): L = LEFT TETHERED ODF FRONT ACCESS CASSETTE R = RIGHT TETHERED ODF FRONT ACCESS CASSETTE			
											CONNECTORS (ONLY ON 1 END): 9 = ODF FLEXCORE UNIVERSAL ENCLOSURE - LC PC M = ODF FLEXCORE UNIVERSAL ENCLOSURE - LC APC			
											FLAME RATING: M = LSZH EUROCLASS Ccd/RISER OFNR (OFS ACCU RISER 288-864)			
											CABLE TYPE: N = INDOOR/OUTDOOR TRUNK			
											FIBER COUNT: B = 288 FIBERS			
											FIBER TYPE: B = BISMF G.657.A2 9/125um SINGLEMODE			
											PRODUCT DESIGNATION: F = FIBER			

\*DUE TO LARGE NUMBER OF TERMINATIONS, STD. PERFORMANCE FOR THIS PRODUCT IS THE FOLLOWING FOR CONNECTOR LOSS

LC/PC: IL LESS THAN 0.6dB, RL GREATER THAN 55dB  
LC/APC: IL LESS THAN 0.5dB, RL GREATER THAN 55dB

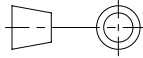
PART NUMBER		F8BNM**BNS*****										
TITLE		288 Fiber Tethered FlexCore ODF Enclosure Tethered Left or Right to Blunt End [All Lengths up to 240ft. (73m)]										
		CUSTOMER DRAWING										
ITEM REVISION NAME		01171EAK/01										
DATASET FILE NAME		01171EAK_DC/01A										
		THIRD ANGLE PROJECTION										
MATERIAL		N/A										
		DRAWING NUMBER 01171EAK-DC										
REV	DATE	BY	CHK	APR	DESCRIPTION	ECN	DRAWN BY	DATE	CHK	SCALE	SHEET 4 OF 4	SIZE
					SEE SHEET 1 FOR REVISION HISTORY		SAT	09/21/22	BJBE	NONE		A

A-SIZE CUSTOMER