



# WT34-R240

W34

COMPACT PHOTOELECTRIC SENSORS

**SICK**  
Sensor Intelligence.



Illustration may differ



### Ordering information

Type	Part no.
WT34-R240	1019239

Other models and accessories → [www.sick.com/W34](http://www.sick.com/W34)

### Detailed technical data

#### Features

<b>Functional principle</b>	Photoelectric proximity sensor
<b>Functional principle detail</b>	Background suppression
<b>Dimensions (W x H x D)</b>	27 mm x 92 mm x 70 mm
<b>Housing design (light emission)</b>	Rectangular
<b>Sensing range max.</b>	100 mm ... 1,200 mm <sup>1)</sup>
<b>Sensing range</b>	100 mm ... 1,200 mm
<b>Type of light</b>	Visible red light
<b>Light source</b>	LED <sup>2)</sup>
<b>Light spot size (distance)</b>	Ø 40 mm (1,200 mm)
<b>Wave length</b>	660 nm
<b>Adjustment</b>	Potentiometer

<sup>1)</sup> Object with 90% remission (based on standard white, DIN 5033).

<sup>2)</sup> Average service life: 100,000 h at T<sub>J</sub> = +25 °C.

#### Mechanics/electronics

<b>Supply voltage U<sub>B</sub></b>	20 V AC/DC ... 250 V AC/DC
<b>Power consumption</b>	< 2 VA
<b>Switching output</b>	Relay, electrically isolated <sup>1)</sup>
<b>Output function</b>	Change-over contacts
<b>Switching mode</b>	Light switching, Dark switching <sup>1)</sup>
<b>Switching mode selector</b>	Selectable via light/dark selector

<sup>1)</sup> Provide suitable spark suppression for inductive or capacitive loads.

<sup>2)</sup> With light/dark ratio 1:1.

<sup>3)</sup> A = V<sub>S</sub> connections reverse-polarity protected.

<sup>4)</sup> C = interference suppression.

<sup>5)</sup> Rated voltage: 250 V AC/DC.

<b>Switching current (switching voltage)</b>	4 A @ 250 V AC, 4 A @ 24 V DC, 0.125 A @ 250 V DC
<b>Response time</b>	≤ 10 ms
<b>Switching frequency</b>	10 Hz <sup>2)</sup>
<b>Connection type</b>	Terminal connection with M16 gland
<b>Circuit protection</b>	A <sup>3)</sup> C <sup>4)</sup>
<b>Protection class</b>	II <sup>5)</sup>
<b>Weight</b>	140 g
<b>Housing material</b>	Plastic, ABS
<b>Enclosure rating</b>	IP67
<b>Ambient operating temperature</b>	-40 °C ... +60 °C
<b>Ambient temperature, storage</b>	-40 °C ... +75 °C
<b>UL File No.</b>	NRKH.E181493 & NRKH7.E181493

1) Provide suitable spark suppression for inductive or capacitive loads.

2) With light/dark ratio 1:1.

3) A = V<sub>S</sub> connections reverse-polarity protected.

4) C = interference suppression.

5) Rated voltage: 250 V AC/DC.

### Safety-related parameters

<b>MTTF<sub>D</sub></b>	509 years
<b>DC<sub>avg</sub></b>	0 %
<b>T<sub>M</sub> (mission time)</b>	20 years

### Classifications

<b>ECLASS 5.0</b>	27270904
<b>ECLASS 5.1.4</b>	27270904
<b>ECLASS 6.0</b>	27270904
<b>ECLASS 6.2</b>	27270904
<b>ECLASS 7.0</b>	27270904
<b>ECLASS 8.0</b>	27270904
<b>ECLASS 8.1</b>	27270904
<b>ECLASS 9.0</b>	27270904
<b>ECLASS 10.0</b>	27270904
<b>ECLASS 11.0</b>	27270904
<b>ECLASS 12.0</b>	27270903
<b>ETIM 5.0</b>	EC002719
<b>ETIM 6.0</b>	EC002719
<b>ETIM 7.0</b>	EC002719
<b>ETIM 8.0</b>	EC002719
<b>UNSPSC 16.0901</b>	39121528

### Dimensional drawing (Dimensions in mm (inch))

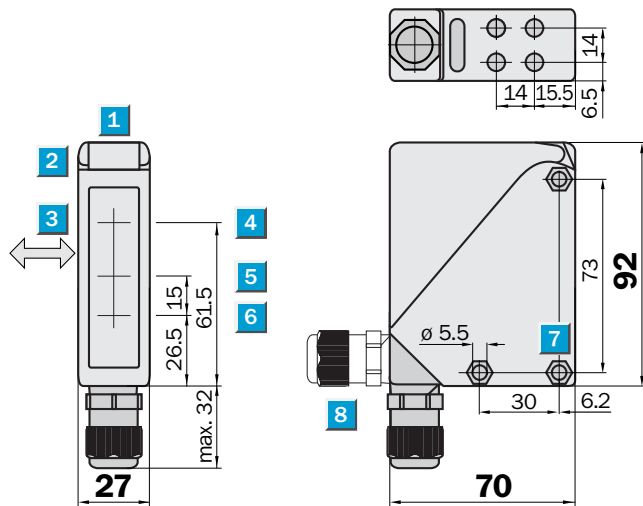

- ① Alignment sight
- ② LED signal strength indicator
- ③ Standard direction of the material being detected
- ④ Center of optical axis, sender
- ⑤ Center of optical axis, receiver (close range)
- ⑥ Center of optical axis, receiver (far range)
- ⑦ Mounting hole  $\varnothing$  5.5 mm, for M5 hexagon nuts on both sides

### Adjustments

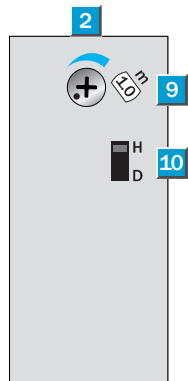

- ② LED signal strength indicator
- ⑨ Adjustment of sensing range
- ⑩ Light/dark selector

### Connection type

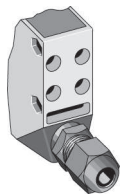

### Connection diagram

Cd-167

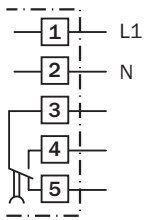

### Characteristic curve

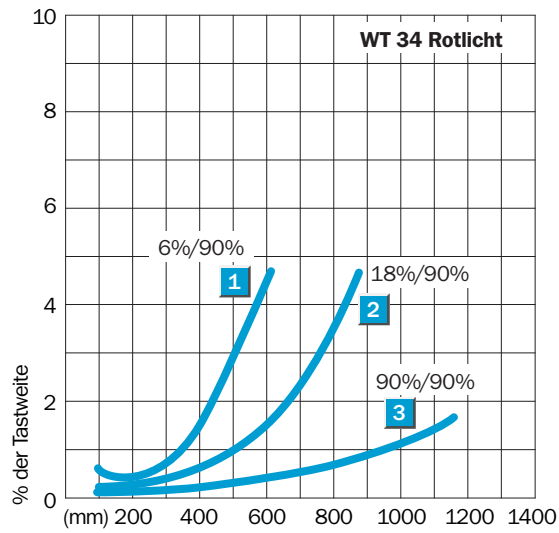

### Sensing range diagram

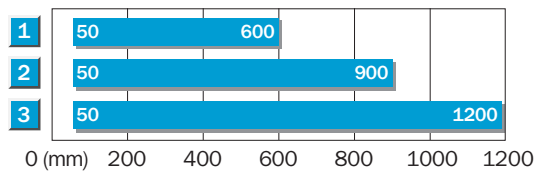

1	Scanning distance on black <sup>9)</sup>
2	Scanning distance on grey <sup>9)</sup>
3	Scanning distance on white <sup>9)</sup>

### Recommended accessories

Other models and accessories → [www.sick.com/W34](http://www.sick.com/W34)

	Brief description	Type	Part no.
Mounting brackets and plates			
	Mounting bracket, Stainless steel (1.4301), mounting hardware included	BEF-WN-W24	2015248

## SICK AT A GLANCE

SICK is one of the leading manufacturers of intelligent sensors and sensor solutions for industrial applications. A unique range of products and services creates the perfect basis for controlling processes securely and efficiently, protecting individuals from accidents and preventing damage to the environment.

We have extensive experience in a wide range of industries and understand their processes and requirements. With intelligent sensors, we can deliver exactly what our customers need. In application centers in Europe, Asia and North America, system solutions are tested and optimized in accordance with customer specifications. All this makes us a reliable supplier and development partner.

Comprehensive services complete our offering: SICK LifeTime Services provide support throughout the machine life cycle and ensure safety and productivity.

For us, that is “Sensor Intelligence.”

## WORLDWIDE PRESENCE:

Contacts and other locations –[www.sick.com](http://www.sick.com)