



AHS36A-S3QK016384

AHS/AHM36

ABSOLUTE ENCODERS

SICK
Sensor Intelligence.



Ordering information

Type	Part no.
AHS36A-S3QK016384	1101567

Other models and accessories → www.sick.com/AHS_AHM36

Illustration may differ



Detailed technical data

Performance

Number of steps per revolution (max. resolution)	16,384 (14 bit)
Error limits G	0.35° (at 20 °C) ¹⁾
Repeatability standard deviation σ_r	0.2° (at 20 °C) ²⁾

¹⁾ In accordance with DIN ISO 1319-1, position of the upper and lower error limit depends on the installation situation, specified value refers to a symmetrical position, i.e. deviation in upper and lower direction is the same.

²⁾ In accordance with DIN ISO 55350-13; 68.3% of the measured values are inside the specified area.

Interfaces

Communication interface	IO-Link
Communication Interface detail	IO-Link V1.1 / COM3 (230,4 kBaud)
Initialization time	2 s ¹⁾
Cycle time	≤ 3.2 ms
Smart Sensor	Efficient communication, Enhanced Sensing, diagnosis
Process data	Position, speed, electronic cams, limit values, linear position, linear speed, errors and warnings, switching signals on pin 2
Parameterising data	Number of steps per revolution PRESET Counting direction Sampling rate for speed calculation Unit for output of the speed value Electronic cams(2 channels x 8 cams) Limit values Linear measuring length per 360° Pin 2 configuration
Available diagnostics data	Minimum and maximum temperature Maximum speed Power-on counter Operating hours counter power-on/motion Counter of direction changes/number of movements cw/number of movements ccw Minimum and maximum operating voltage Distance covered

¹⁾ Valid positional data can be read once this time has elapsed.

Status information	Via status LED
Switching input/Switching output	✓
Pin 2 input frequency	≤ 100 Hz
Pin 2 output frequency	≤ 100 Hz

¹⁾ Valid positional data can be read once this time has elapsed.

Electrical data

Connection type	Cable, 4-wire, universal, 1.5 m
Supply voltage	18 ... 30 V
Power consumption	≤ 1.5 W
Reverse polarity protection	✓
MTTFd: mean time to dangerous failure	240 years (EN ISO 13849-1) ¹⁾

¹⁾ This product is a standard product and does not constitute a safety component as defined in the Machinery Directive. Calculation based on nominal load of components, average ambient temperature 40 °C, frequency of use 8760 h/a. All electronic failures are considered hazardous. For more information, see document no. 8015532.

Mechanical data

Mechanical design	Solid shaft, face mount flange
Shaft diameter	6 mm
Shaft length	12 mm
Weight	0.12 kg ¹⁾
Shaft material	Stainless steel
Flange material	Aluminum
Housing material	Zinc
Start up torque	< 1 Ncm (+20 °C)
Operating torque	< 1 Ncm (+20 °C)
Permissible shaft loading	40 N (radial) 20 N (axial)
Operating speed	≤ 6,000 min ⁻¹
Moment of inertia of the rotor	2.5 gcm ²
Bearing lifetime	3.6 x 10 ⁸ revolutions
Angular acceleration	≤ 500,000 rad/s ²

¹⁾ Based on devices with male connector.

Ambient data

EMC	According to EN 61000-6-2, EN 61000-6-3 and EN 61131-9
Enclosure rating	IP66 (IEC 60529) IP67 (IEC 60529)
Permissible relative humidity	90 % (Condensation not permitted)
Operating temperature range	-40 °C ... +85 °C
Storage temperature range	-40 °C ... +100 °C, without package
Resistance to shocks	100 g, 6 ms (EN 60068-2-27)
Resistance to vibration	20 g, 10 Hz ... 2,000 Hz (EN 60068-2-6)

Classifications

ECLASS 5.0	27270502
ECLASS 5.1.4	27270502
ECLASS 6.0	27270590
ECLASS 6.2	27270590
ECLASS 7.0	27270502
ECLASS 8.0	27270502
ECLASS 8.1	27270502
ECLASS 9.0	27270502
ECLASS 10.0	27270502
ECLASS 11.0	27270502
ECLASS 12.0	27270502
ETIM 5.0	EC001486
ETIM 6.0	EC001486
ETIM 7.0	EC001486
ETIM 8.0	EC001486
UNSPSC 16.0901	41112113

Dimensional drawing (Dimensions in mm (inch))

Solid shaft, face mount flange, cable

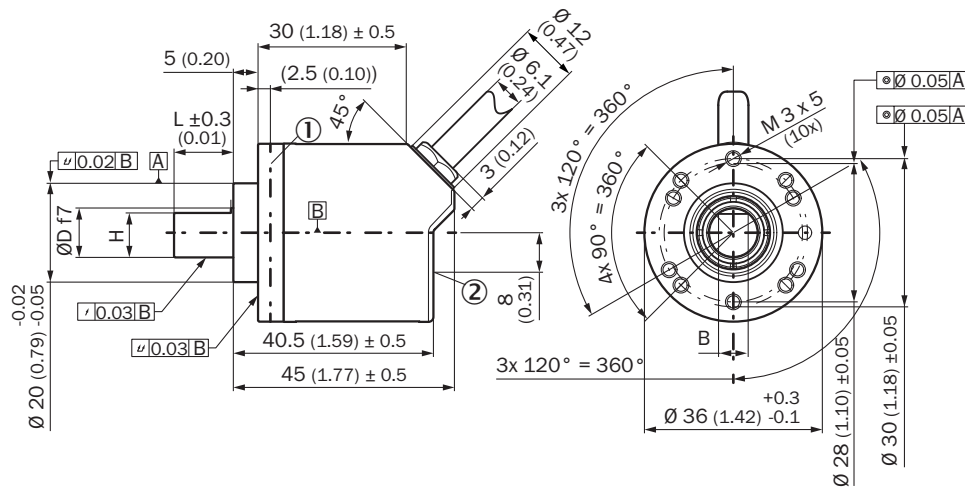

- ① Measuring point for operating temperature
- ② Measuring point for vibrations

Type	Shaft diameter Ø D f7	B	H
AHx36x-S1xxxxxxx AHx36x-S3xxxxxxx	6 mm	3,6 mm	5,4 mm
AHx36x-S9xxxxxxx AHx36x-S5xxxxxxx	8 mm	3,9 mm	7,5 mm
AHx36x-S2xxxxxxx AHx36x-S4xxxxxxx AHx36x-SCxxxxxxx	10 mm	6 mm	9 mm

Type	Shaft diameter Ø D f7	B	H
AHx36x-SAxxxxxxx AHx36x-S8xxxxxxx	1/4"	3,85 mm	5,7 mm
AHx36x-SBxxxxxxx AHx36x-S7xxxxxxx	3/8"	4,35 mm	9 mm

Attachment specifications

Solid shaft, face mount flange with flange adapter, centering collar D20 on D50 (BEF-FA-020-050, 2072297)

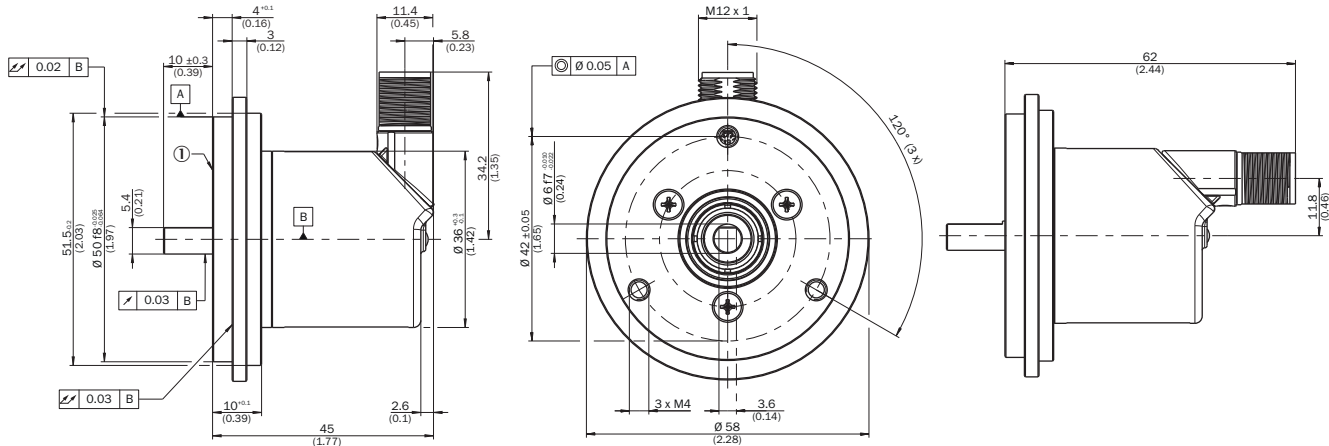

Order example for 6 mm shaft diameter: AHx36x-S3xx0xxxxx + BEF-FA-020-050 (adapter is not pre-assembled)

① Measuring point for operating temperature

Solid shaft, face mount flange with flange adapter, centering collar D20 on D36, 2 mm high (BEF-FA-020-036-002, 2072296)

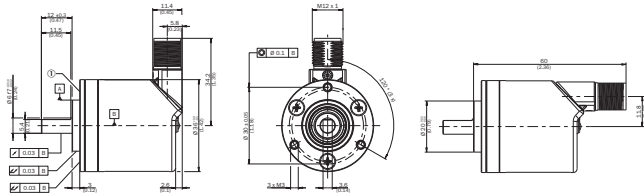

Order example for 6 mm shaft diameter: AHx36x-S3xx0xxxxx + BEF-FA-020-036-002 (adapter is not pre-assembled)

① Measuring point for operating temperature

Solid shaft, face mount flange with flange adapter, centering collar D20 on D24 (BEF-FA-020-024, 2072294)

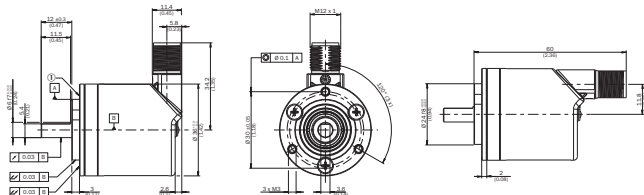

Order example for 6 mm shaft diameter: AHx36x-S3xx0xxxxx + BEF-FA-020-024 (adapter is not pre-assembled)

① Measuring point for operating temperature



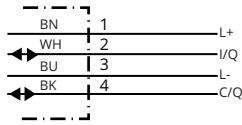











PIN assignment











PIN	Wire color	Signal	Function		
			Basic	Advanced	Advanced Smart Task
1	Brown	L+	Encoder supply voltage 18-30 V (+Us)		
2	White	I/Q	Not connected - no function	Multifunctional pin (configurable as switching input or switching output)	
3	Blue	L-	Encoder supply voltage 0 V (GND)		
4	Black	C/Q	IO-Link communication		Switching output (SIO mode)

Recommended accessories

Other models and accessories → www.sick.com/AHS_AHM36

	Brief description	Type	Part no.
Other mounting accessories			
	O-ring for measuring wheels (circumference 200 mm)	BEF-OR-053-040	2064061
	O-ring for measuring wheels (circumference 300 mm), 2x O-ring	BEF-OR-083-050	2064076
Plug connectors and cables			
		DOS-1204-G	6007302
Shaft adaptation			
		KUP-0606-B	5312981
		KUP-0610-B	5312982
		KUP-0610-D	5326697
		KUP-0610-F	5312985
		KUP-0610-J	2127056
Others			
		YF2A14-020UB3M2A14	2096000
		YF2A14-050UB3M2A14	2096001

	Brief description	Type	Part no.
		YF2A14-100UB3M2A14	2096002
		YF2A14-020UB3XLEAX	2095607
		YF2A14-050UB3XLEAX	2095608
		YF2A14-100UB3XLEAX	2095609

SICK AT A GLANCE

SICK is one of the leading manufacturers of intelligent sensors and sensor solutions for industrial applications. A unique range of products and services creates the perfect basis for controlling processes securely and efficiently, protecting individuals from accidents and preventing damage to the environment.

We have extensive experience in a wide range of industries and understand their processes and requirements. With intelligent sensors, we can deliver exactly what our customers need. In application centers in Europe, Asia and North America, system solutions are tested and optimized in accordance with customer specifications. All this makes us a reliable supplier and development partner.

Comprehensive services complete our offering: SICK LifeTime Services provide support throughout the machine life cycle and ensure safety and productivity.

For us, that is “Sensor Intelligence.”

WORLDWIDE PRESENCE:

Contacts and other locations –www.sick.com