



Product designation				Power contactor
Product type designation				BF18
<b>Contact characteristics</b>				
Number of poles	Nr.			4
Rated insulation voltage U <sub>i</sub> IEC/EN	V			690
Rated impulse withstand voltage U <sub>imp</sub>	kV			6
Operational frequency	min	Hz		25
	max	Hz		400
IEC Conventional free air thermal current I <sub>th</sub>	A			32
Operational current I <sub>e</sub>	AC-1 (≤40°C)	A		32
	AC-1 (≤55°C)	A		26
	AC-1 (≤70°C)	A		23
	AC-3 (≤440V ≤55°C)	A		18
	AC-4 (400V)	A		8.5
Rated operational power AC-1 (T≤40°C)	230V	kW		12
	400V	kW		21
	500V	kW		26
	690V	kW		36
Short-time allowable current for 10s (IEC/EN60947-1)	A			200
Protection fuse	gG (IEC)	A		32
	aM (IEC)	A		20
Making capacity (RMS value)	A			180
Breaking capacity at voltage	440V	A		144
	500V	A		120
	690V	A		94
Resistance per pole (average value)	mΩ			2.5
Power dissipation per pole (average value)	I <sub>th</sub>	W		2.6
	AC-3	W		0.8
Tightening torque for terminals	min	Nm		1.5
	max	Nm		1.8
	min	lbin		1.1
	max	lbin		1.5
Tightening torque for coil terminal	min	Nm		0.8
	max	Nm		1
	min	lbin		0.8
	max	lbin		0.74
Max number of wires simultaneously connectable	Nr.			2

Conductor section			
AWG/Kcmil		max	10
Flexible w/o lug conductor section			
		min	mm <sup>2</sup> 1
		max	mm <sup>2</sup> 6
Flexible c/w lug conductor section			
		min	mm <sup>2</sup> 1
		max	mm <sup>2</sup> 4
Flexible with insulated spade lug conductor section			
		min	mm <sup>2</sup> 1
		max	mm <sup>2</sup> 4
Power terminal protection according to IEC/EN 60529			IP20 when properly wired
<b>Mechanical features</b>			
Operating position			
		normal allowable	Vertical plan ±30°
Fixing			Screw / DIN rail 35mm
Weight			g 496
Conductor section			
AWG/kcmil conductor section		max	10
<b>Operations</b>			
Mechanical life		cycles	20000000
Electrical life		cycles	1600000
<b>Safety related data</b>			
Performance level B10d according to EN/ISO 13489-1			
		rated load	cycles 1600000
		mechanical load	cycles 20000000
Mirror contacts according to IEC/EN 60947-4-1			YES
EMC compatibility			yes
<b>DC coil operating</b>			
DC rated control voltage		V	125
DC operating voltage			
pick-up		min	%Us 70
		max	%Us 125
drop-out		min	%Us 10
		max	%Us 40
Average coil consumption ≤20°C			
		in-rush	W 5.4
		holding	W 5.4
<b>Max cycles frequency</b>			
Mechanical operation		cycles/h	3600
<b>Operating times</b>			
Average time for Us control			
in AC		Closing NO	
		min	ms 8
		max	ms 24

Opening NO	min	ms	10
	max	ms	20
Closing NC	min	ms	14
	max	ms	28
Opening NC	min	ms	7
	max	ms	18
<hr/>			
in DC			
Closing NO	min	ms	54
	max	ms	66
Opening NO	min	ms	14
	max	ms	17
Closing NC	min	ms	24
	max	ms	30
Opening NC	min	ms	47
	max	ms	57

**UL technical data**

Full-load current (FLA) for three-phase AC motor

at 480V	A	14
at 600V	A	17

Yielded mechanical performance

for single-phase AC motor

110/120V	HP	1
230V	HP	3

for three-phase AC motor

200/208V	HP	5
220/230V	HP	5
460/480V	HP	10
575/600V	HP	15

General USE

Contactor

AC current	A	32
------------	---	----

**Ambient conditions**

Temperature

Operating temperature

min	°C	-50
max	°C	70

Storage temperature

min	°C	-60
max	°C	80

Max altitude

m	3000
---	------

**Resistance & Protection**

Pollution degree

3

**Dimensions**

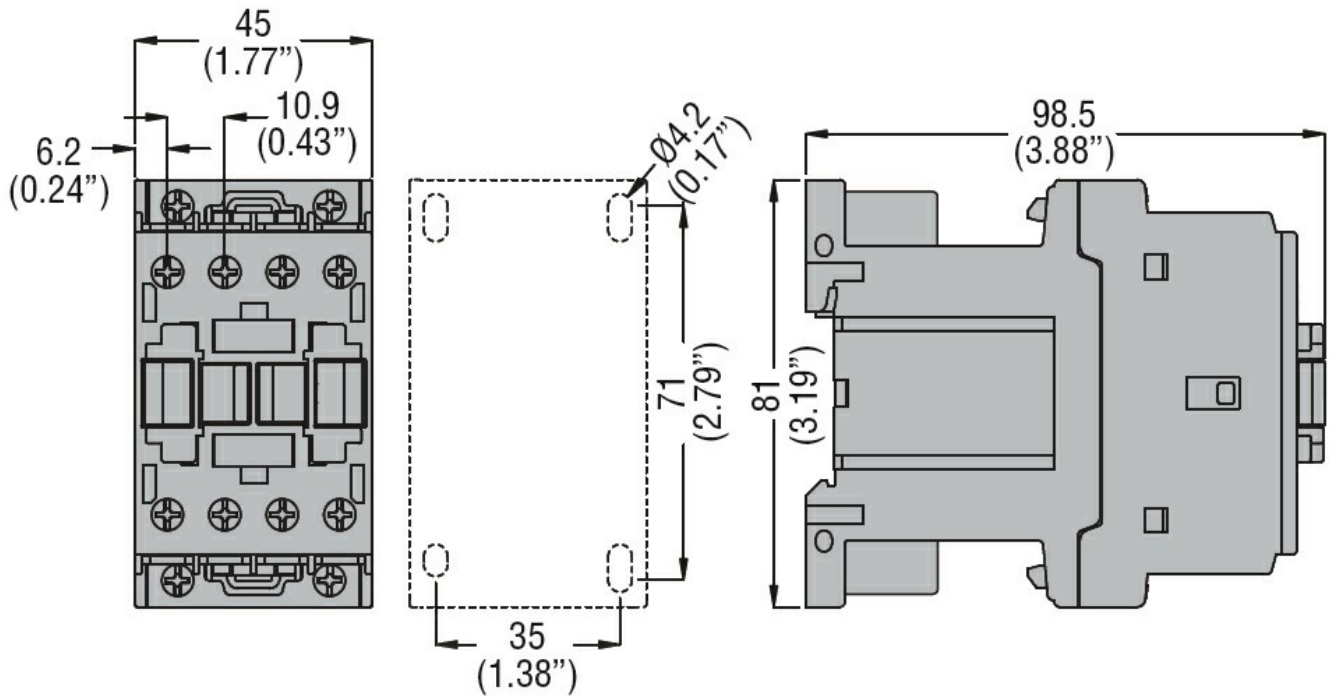

### Wiring diagrams

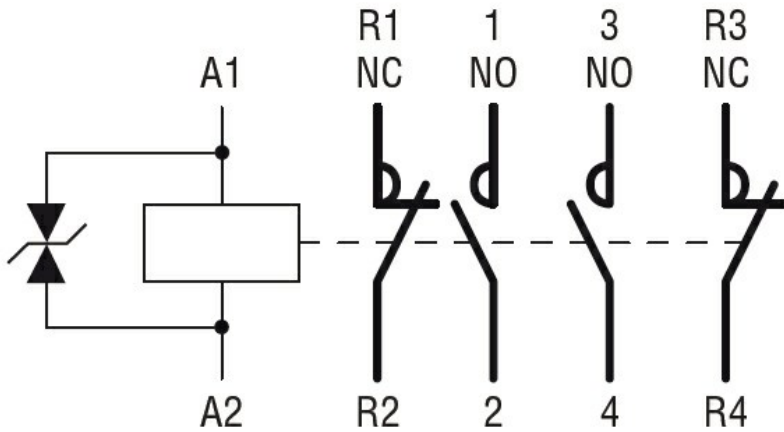

### Certifications and compliance

#### Compliance

CSA C22.2 n° 60947-1

CSA C22.2 n° 60947-4-1

IEC/EN/BS 60947-1

IEC/EN/BS 60947-4-1

UL 60947-1

UL 60947-4-1

#### Certificates

CCC

cULus

EAC

### ETIM classification

ETIM 8.0

EC000066 -  
Power contactor,  
AC switching