

PRODUCT PRESENTATION

- **NFS 61-937**
- **Monitored**
- **Flush mount**
- **High corrosion resistance**
- **Delivered with armature plate**
- **No mechanical wear**
- **No residual magnetism**
- **Ease of installation**
- **Recommended for interior use**
- **Fail safe** (Door unlocked when power off)
- **Holding force: 300 kg**
- **Built-in varistor: Built-in electronic protection to eliminate back EMF**
- **Dimensions (L x W x D): 228 x 35.5 x 24.5 mm**
- **Armature plate dimensions (L x W x D): 185 x 38 x 11 mm**
- **Power supply: 12-24V dc**
- **Consumption: 480 mA @ 12V dc**
240 mA @ 24V dc

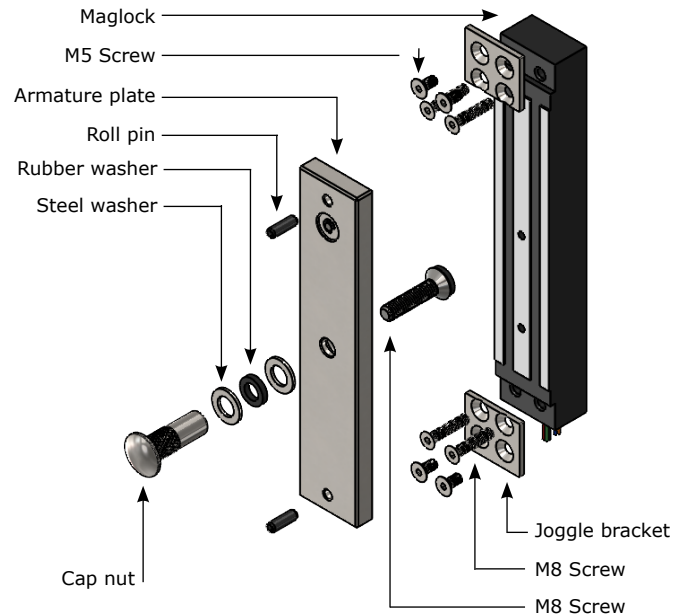

IP42 WEEE & RoHS CE Certification



PACKAGE CONTENT

Magnetic lock	Armature plate	5x16 Roll pin	M5X8 Srew	Steel washer	Rubber washer
1	1	2	4	2	1
M8x35 Screw	M8x25 Screw	Cap nut	Joggle bracket	Manual	
1	4	1	2	1	

ELECTRICAL CONNECTIONS

12V dc Default setup

Terminal block	Correspondence
+	12 or 24V dc
-	0V
N.C	NC (Normally closed)
COM	COM
N.O	NO (Normally open)

The NO/NC signal only switches when the door is closed with the power to it on.

IMPORTANT NOTE

- Check the jumper position before connecting the lock to the input current. A wrong position could damage the lock. This type of damage is not covered by the warranty.
- Make sure that the magnet and the armature meet evenly over their entire mating surfaces.

The Armature plate must be able to pivot slightly about its center mounting screw to compensate for any door misalignment.

Voltage selection jumpers

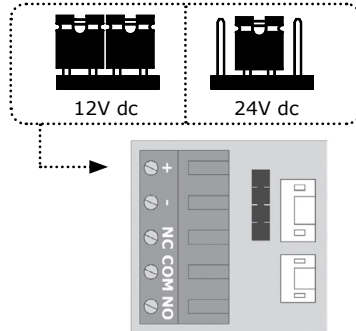

Recommended power supplies

Voltage	ADC335	ADC612S
12V dc	ADC335	ADC612S
24V dc	ADC324	ADC624S

MOUNTING RECOMMENDATIONS

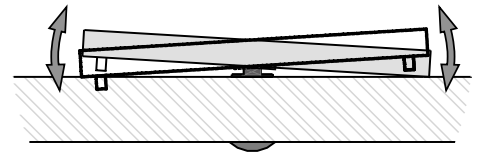

Armature plate

- It is vital that the magnetic lock and armature plate are securely fixed to their supports.
- The magnetic lock and the armature plate must be aligned.
- The armature plate must be mounted "floating" around the central mounting screw to compensate for any misalignment of the door

OPTIONAL ACCESSORIES

	AMB300
References	AMB300
Description	For armature plate

CDVI FRANCE + EXPORT
31, av. du Général Leclerc
93500 PANTIN - France
Phone +33 (0)1 48 91 01 02
www.cdvi.com

CDVI UK
[UNITED KINGDOM - IRELAND]
Phone +44 (0)1628 531300
www.cdvi.co.uk

CDVI BENELUX
[BELGIUM - NETHERLAND - LUXEMBOURG]
Phone +32 (0) 56 73 93 00
www.cdvi-benelux.com

CDVI IBÉRICA
[SPAIN - PORTUGAL]
Phone +34 (0)935 390 966
www.cdvi-iberica.com

CDVI TAIWAN
Phone +886 (0)42471 2188
www.cdvi-china.cn

CDVI POLSKA
Phone +48 12 659 23 44
www.cdvi.com.pl

CDVI SWEDEN
[SWEDEN - DENMARK - NORWAY FINLAND]
Phone +46 (0)31 760 19 30
www.cdvi.se

CDVI AMERICAS
[CANADA - USA]
Phone +1 (450) 682 7945
www.cdvi.ca

CDVI SUISSE
Phone +41 (0)21 882 18 41
www.cdvi.ch

CDVI ITALIA
Phone +39 0321 90 573
Fax: +39 0321 90 8018
www.cdvi.it

CDVI CHINA
Phone +86 10 84606132/82
www.cdvi-china.cn

CDVI GERMANY
+49 (0) 175 2932 901
www.cdvi.de

CDVI MAROC
Phone +212 5 2248 0940
www.cdvi.ma

www.cdvi.com

PRÉSENTATION DU PRODUIT

- **NFS 61-937**
- **Signal**
- **Encastrée**
- **Résistance à la corrosion**
- **Livrée avec contre-plaque**
- **Pas d'usure mécanique**
- **Pas de magnétisme résiduel**
- **Facilité d'installation**
- **Préconisée en intérieur**
- **Libère l'accès en cas de coupure de courant**
- **Force de rétention : 300kg**
- **Varistance incorporée : Protection électronique intégrée contre l'effet de self**
- **Dimensions (L x l x P) : 228 x 35,5 x 24,5 mm**
- **Dimensions contre-plaque (L x l x P) : 185 x 38 x 11 mm**
- **Alimentation : 12-24V DC**
- **Consommation : 480 mA en 12V DC
240 mA en 24V DC**

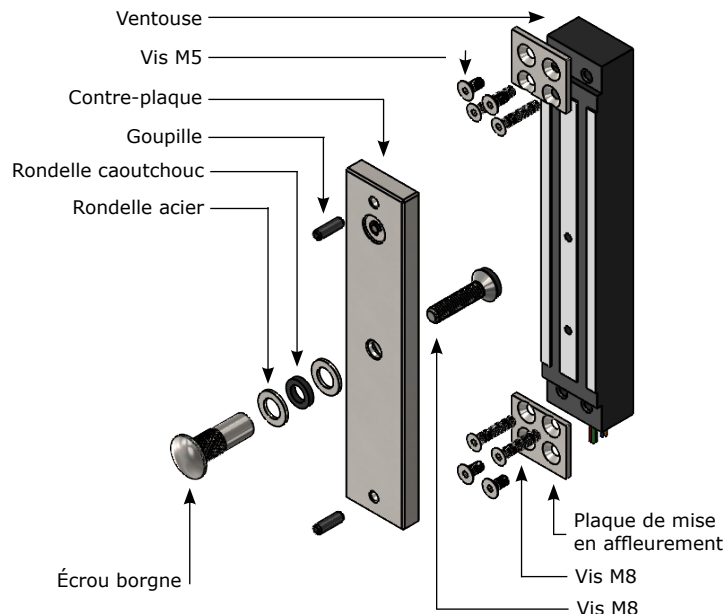

IP42 DEEE & RoHS Certification CE

ÉLÉMENTS INCLUS

Ventouse encastrée	Contre-plaque	Goupille 5x16	Vis M5X8	Rondelle acier	Rondelle caoutchouc
1	1	2	4	2	1
Vis M8x35	Vis M8x25	Écrou borgne	Plaque de mise en affleurement	Notice	
1	4	1	2	1	

RECOMMANDATIONS DE MONTAGE

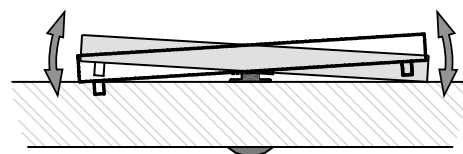

Contre-plaque

- Il est vital de fixer solidement la ventouse et la contreplaque sur leurs supports.
- La ventouse et la contre-plaque doivent être impérativement alignées.
- La contre-plaque doit être montée "flottante" autour de la vis centrale de montage pour compenser un mauvais alignement de la porte.

RACCORDEMENTS

⚠ Réglage usine 12V DC

Bornier	Correspondance
+	12 ou 24V DC
-	0V
N.C	NF (Normalement fermé)
COM	COM
N.O	NO (Normalement ouvert)

Le signal NO/NF ne commute que lorsque la porte fermée et sous tension.

NOTE IMPORTANTE

- Vérifier la position du cavalier avant de brancher la ventouse au courant d'entrée. Une position incorrecte peut endommager la ventouse. Ce type de dommage n'est pas couvert par la garantie.
- La ventouse et la contre-plaque doivent être impérativement alignés.

La contre-plaque doit être montée "flottante" autour de la vis centrale de montage pour compenser un mauvais alignement de la porte.

Cavaliers de sélection de tension

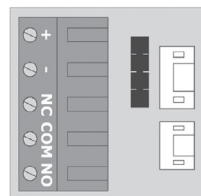
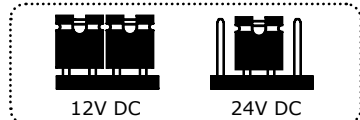

Alimentations recommandées

Tension	ADC335	ADC612S
12V DC	ADC335	ADC612S
24V DC	ADC324	ADC624S

ACCESSOIRES EN OPTION

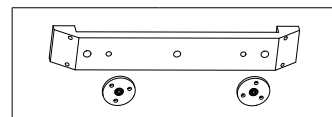

Références	AMB300
Description	Pour contreplaque

CDVI FRANCE + EXPORT
31, av. du Général Leclerc
93500 PANTIN - France
Phone +33 (0)1 48 91 01 02
www.cdvi.com

CDVI UK
[UNITED KINGDOM - IRELAND]
Phone +44 (0)1628 531300
www.cdvi.co.uk

CDVI BENELUX
[BELGIUM - NETHERLAND - LUXEMBOURG]
Phone +32 (0) 56 73 93 00
www.cdvi-benelux.com

CDVI IBÉRICA
[SPAIN - PORTUGAL]
Phone +34 (0)935 390 966
www.cdvi-iberica.com

CDVI TAIWAN
Phone +886 (0)42471 2188
www.cdvi-china.cn

CDVI POLSKA
Phone +48 12 659 23 44
www.cdvi.com.pl

CDVI SWEDEN
[SWEDEN - DENMARK - NORWAY FINLAND]
Phone +46 (0)31 760 19 30
www.cdvi.se

CDVI AMERICAS
[CANADA - USA]
Phone +1 (450) 682 7945
www.cdvi.ca

CDVI SUISSE
Phone +41 (0)21 882 18 41
www.cdvi.ch

CDVI ITALIA
Phone +39 0321 90 573
Fax: +39 0321 90 8018
www.cdvi.it

CDVI MAROC
Phone +212 5 2248 0940
www.cdvi.ma

CDVI GERMANY
+49 (0) 175 2932 901
www.cdvi.de
www.cdvi.com