



VL18-2T2162

V18

CYLINDRICAL PHOTOELECTRIC SENSORS

SICK
Sensor Intelligence.



Ordering information

Type	Part no.
VL18-2T2162	6011377

Other models and accessories → www.sick.com/V18

Illustration may differ



Detailed technical data

Features

Functional principle	Photoelectric retro-reflective sensor
Dimensions (W x H x D)	18 mm x 18 mm x 88 mm
Housing design (light emission)	Cylindrical
Housing length	88 mm
Thread diameter (housing)	M18 x 1
Optical axis	Axial
Sensing range max.	0.005 m ... 3.5 m ¹⁾
Sensing range	0.01 m ... 3 m ¹⁾
Focus	6°
Type of light	Infrared light
Light source	LED ²⁾
Light spot size (distance)	Ø 30 mm (3 m)
Angle of dispersion	6°
Adjustment	None

¹⁾ Reflector C110A.

²⁾ Average service life: 100,000 h at T_J = +25 °C.

Mechanics/electronics

Supply voltage U_B	20 V AC ... 253 V AC ¹⁾
Mains frequency	50 Hz, 60 Hz
Current consumption	30 mA ²⁾

¹⁾ Limit values.

²⁾ Without load.

³⁾ Depending on supply voltage VS.

⁴⁾ Signal transit time with resistive load.

⁵⁾ With light/dark ratio 1:1.

⁶⁾ Do not bend below 0 °C.

⁷⁾ C = interference suppression.

Switching output	TRIAC
Switching mode	Dark switching
Output current I_{max.}	≤ 300 mA ³⁾
Response time	≤ 20 ms ⁴⁾
Switching frequency	25 Hz ⁵⁾
Connection type	Cable, 3-wire, 2 m ⁶⁾
Cable material	PVC
Conductor cross section	0.34 mm ²
Cable diameter	Ø 4.7 mm
Circuit protection	C ⁷⁾
Protection class	III
Weight	95 g
Housing material	Plastic, PBT/PC
Optics material	Plastic, PMMA
Enclosure rating	IP67
Ambient operating temperature	-25 °C ... +60 °C
UL File No.	NMFT2.E175606

1) Limit values.

2) Without load.

3) Depending on supply voltage VS.

4) Signal transit time with resistive load.

5) With light/dark ratio 1:1.

6) Do not bend below 0 °C.

7) C = interference suppression.

Classifications

eCl@ss 5.0	27270902
eCl@ss 5.1.4	27270902
eCl@ss 6.0	27270902
eCl@ss 6.2	27270902
eCl@ss 7.0	27270902
eCl@ss 8.0	27270902
eCl@ss 8.1	27270902
eCl@ss 9.0	27270902
eCl@ss 10.0	27270902
eCl@ss 11.0	27270902
eCl@ss 12.0	27270902
ETIM 5.0	EC002717
ETIM 6.0	EC002717
ETIM 7.0	EC002717
ETIM 8.0	EC002717
UNSPSC 16.0901	39121528

Connection type



Connection diagram

Cd-063

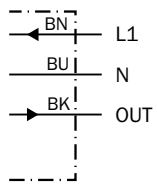

Characteristic curve

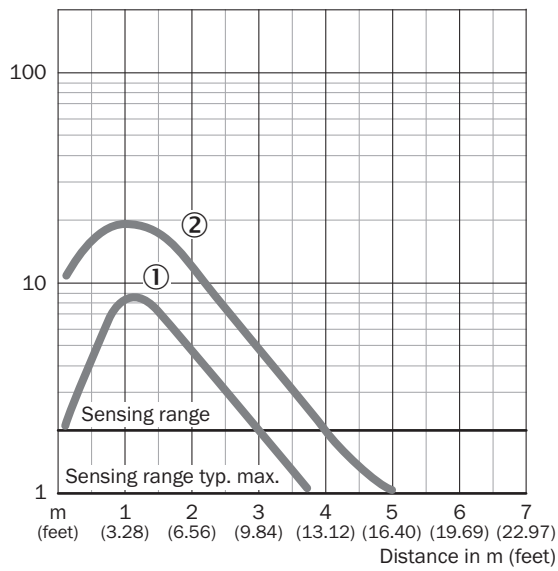



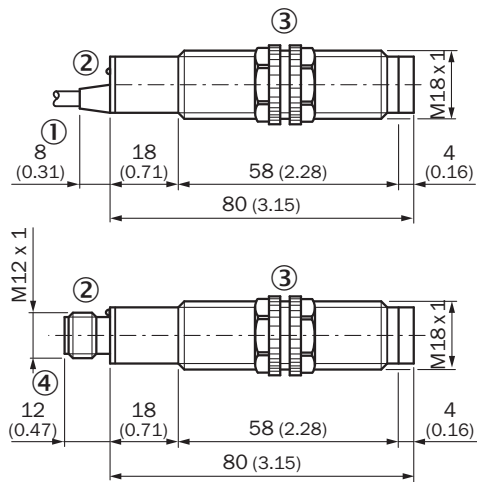

Dimensional drawing (Dimensions in mm (inch))



- ① Connection cable
- ② LED signal strength indicator
- ③ Fastening nuts, 22 mm hex (included)
- ④ Connector M12, 4-pin

Recommended accessories

Other models and accessories → www.sick.com/V18

	Brief description	Type	Part no.
Mounting brackets and plates			
	Mounting bracket for M18 sensors, steel, zinc coated, without mounting hardware	BEF-WN-M18	5308446
	Universal mounting bracket for reflectors, steel, zinc coated	BEF-WN-REFX	2064574
Plug connectors and cables			
	Head A: male connector, M8, 3-pin, straight Cable: unshielded	STE-0803-G	6037322
Reflectors			
	Rectangular, screw connection, 51 mm x 61 mm, PMMA/ABS, Screw-on, 2 hole mounting	P250	5304812

SICK AT A GLANCE

SICK is one of the leading manufacturers of intelligent sensors and sensor solutions for industrial applications. A unique range of products and services creates the perfect basis for controlling processes securely and efficiently, protecting individuals from accidents and preventing damage to the environment.

We have extensive experience in a wide range of industries and understand their processes and requirements. With intelligent sensors, we can deliver exactly what our customers need. In application centers in Europe, Asia and North America, system solutions are tested and optimized in accordance with customer specifications. All this makes us a reliable supplier and development partner.

Comprehensive services complete our offering: SICK LifeTime Services provide support throughout the machine life cycle and ensure safety and productivity.

For us, that is “Sensor Intelligence.”

WORLDWIDE PRESENCE:

Contacts and other locations –www.sick.com