

DEHNguard modular DG M TT 2P 5 CI 275 NL FM

DG M TT 5 CI 275 NL FM

- DE Einbauanleitung
- GB Installation instructions
- IT Istruzioni di montaggio
- FR Instructions de montage
- NL Montagehandleiding
- ES Instrucciones de montaje
- PT Instruções de montagem
- DK Monteringsvejledning
- SE Monteringsanvisning
- FI Asennusohje
- GR Οδηγίες συναρμολόγησης
- PL Instrukcja montażu
- CZ Návod k montáži
- TR Montaj kılavuzu
- RU Инструкция по монтажу
- CN 安装说明
- HU Szerelési útmutató
- JP 設置説明書



II IEC 61643-11...
2 EN 61643-11...

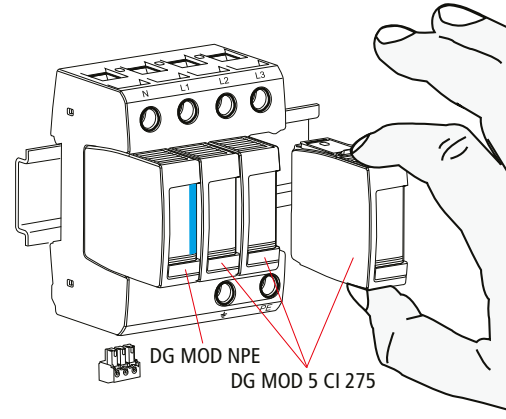
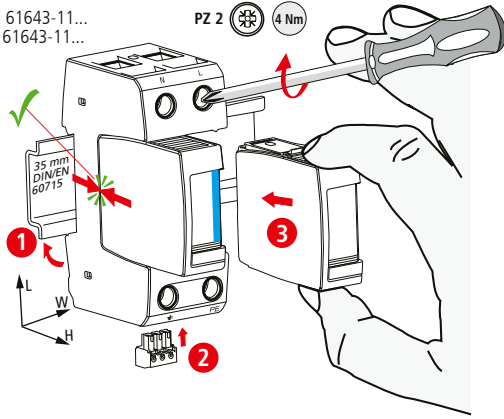

	DG M TT 2P 5 CI 275 NL FM		DG M TT 5 CI 275 NL FM	
	L-N	N-PE	L-N	N-PE
U _N / Tol.: ±10%	230 / 400 V			
U _c	275 V	255 V	275 V	255 V
f _N	50/60 Hz			
I _{SCCR}	6 kA	---	6 kA	---
I _β	---	100 A _{rms}	---	100 A _{rms}
I _{max} (8/20μs)	15 kA	40 kA	15 kA	40 kA
θ°	-40°C ... +80°C			
φ	5% ... 95%			
I _{FE}	< 5 μA		< 5 μA	
IP 1)	20			
L x W x H	90 mm x 36 mm x 73 mm		90 mm x 72 mm x 73 mm	

TT/TN DG M TT 2P 5 CI 275 NL FM

TT/TN-S DG M TT 5 CI 275 NL FM

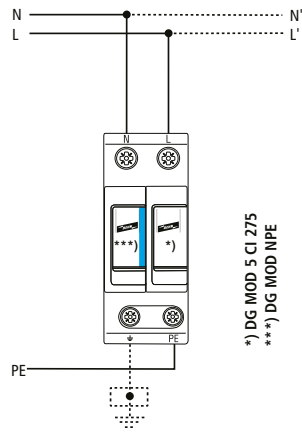

*) DG MOD 5 CI 275
***) DG MOD NPE

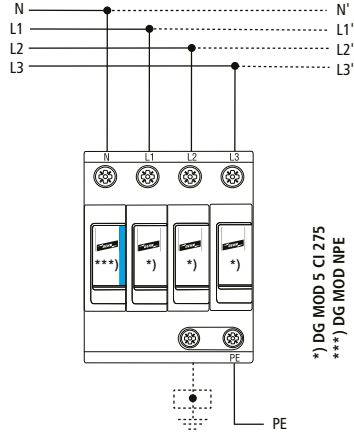

*) DG MOD 5 CI 275
***) DG MOD NPE

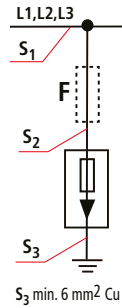

S ₁ / mm ²	max. I _k	S ₂ / mm ²	S ₃ / mm ²	
≤ 25 mm ²	≤ 6 kA	= S ₁	= S ₁ min. 6 mm ²	
≤ 35 mm ²				
> 25 mm ²	≤ 6 kA	16 mm ² 2)	16 mm ²	
> 35 mm ²				

	12 mm	12 mm	12 mm
min. □ L, N, PE, ⊥	1.5 mm ²		
max. □ L, N, PE, ⊥	25 mm ²	35 mm	
	16 mm ² Cu	≥ 15.5 mm	

LPZ 0_A

LPZ 0_B

LPZ 1

LPZ 2

LPZ 3

DEHNguard modular
DG M TT ... 5 CI 275 NL FM

3 / III

DEHNguard modular
DG M TT ... 5 CI 275 ...

2 / II

3 / III

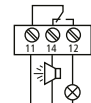
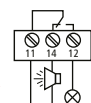
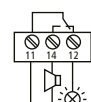
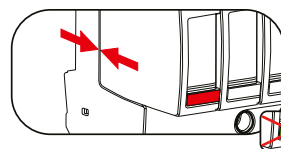
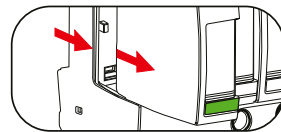
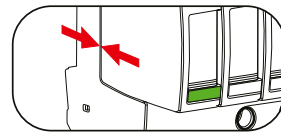

DG MOD 5 CI 275,
DG MOD NPE

DG MOD 5 CI 275,
DG MOD NPE



www.dehn.de
www.dehn-international.com

DEHNguard modular DG M TT 2P 5 CI 275 NL FM,
DG M TT 5 CI 275 NL FM

U _N / I _N	AC: 250 V / 0.5 A
	DC: 250 V / 0.1 A 125 V / 0.2 A 75 V / 0.5 A
	max. 1.5 mm ²

