



UM18-21112E212

UM18

ULTRASONIC DISTANCE SENSORS

SICK
Sensor Intelligence.



Ordering information

| Type | Part no. |
|----------------|----------|
| UM18-21112E212 | 6068442 |

Other models and accessories → www.sick.com/UM18



Detailed technical data

Mechanics/electronics

| | |
|--|--|
| Supply voltage V_s | DC 10 V ... 30 V ¹⁾ |
| Power consumption | ≤ 1.2 W ²⁾ |
| Initialization time | < 300 ms |
| Design | Cylindrical |
| Housing material | Metal (nickel-plated brass, ultrasonic transducer: polyurethane foam, glass epoxy resin) |
| Thread size | M18 x 1 |
| Connection type | Male connector, M12, 5-pin |
| Indication | 2 x LED |
| Weight | 30 g |
| Sending axis | Angled |
| Dimensions (W x H x D) | 18 mm x 18 mm x 68.7 mm |
| Enclosure rating | IP65 / IP67 |
| Protection class | III |

¹⁾ Limit values, reverse-polarity protected Operation in short-circuit protected network: max. 8 A, class 2.

²⁾ Without load.

Safety-related parameters

| | |
|-------------------------|-----------|
| MTTF_D | 101 years |
| DC_{avg} | 0% |

Performance

| | |
|--|--------------------------|
| Operating range, limiting range | 30 mm ... 250 mm, 350 mm |
| Target | Natural objects |

¹⁾ In relation to the current measured value, minimum value ≥ resolution.

²⁾ Referring to current measurement value.

³⁾ Temperature compensation can be switched off, without temperature compensation: 0.17 % / K.

| | |
|---------------------------------------|---|
| Resolution | ≥ 0.069 mm |
| Repeatability | ± 0.15 % ¹⁾ |
| Accuracy | ± 1 % ^{2) 3)} |
| Temperature compensation | ✓ |
| Response time | 32 ms |
| Switching frequency | 25 Hz |
| Output time | 8 ms |
| Ultrasonic frequency (typical) | 320 kHz |
| Additional function | Adjustable operating modes: Switching point (Dt0) / Switching window/Background (ObSB) Teach-in of digital output Invertible digital output Multifunctional input: external teach / synchronization / multiplexing Synchronization of up to 20 sensors Multiplexing: no cross talk of up to 20 sensors Reset to factory default |

¹⁾ In relation to the current measured value, minimum value ≥ resolution.

²⁾ Referring to current measurement value.

³⁾ Temperature compensation can be switched off, without temperature compensation: 0.17 % / K.

Interfaces

| | |
|---------------------------------------|---|
| IO-Link | ✓, IO-Link V1.1 |
| Function | Process data, parameterization, diagnosis, data storage |
| Digital output | |
| Number | 2 ¹⁾ |
| Type | Push-pull: PNP/NPN |
| Maximum output current I _A | ≤ 100 mA |
| Multifunctional input (MF) | 1 x MF |
| Hysteresis | 3 mm |

¹⁾ Push-pull: PNP/NPN HIGH = U_V - (< 3 V) / LOW < 3 V.

Ambient data

| | |
|---------------------------------------|-------------------|
| Ambient temperature, operation | -25 °C ... +70 °C |
| Ambient temperature, storage | -40 °C ... +85 °C |

Classifications

| | |
|---------------------|----------|
| ECLASS 5.0 | 27270804 |
| ECLASS 5.1.4 | 27270804 |
| ECLASS 6.0 | 27270804 |
| ECLASS 6.2 | 27270804 |
| ECLASS 7.0 | 27270804 |
| ECLASS 8.0 | 27270804 |
| ECLASS 8.1 | 27270804 |
| ECLASS 9.0 | 27270804 |
| ECLASS 10.0 | 27270804 |
| ECLASS 11.0 | 27270804 |
| ECLASS 12.0 | 27272806 |

| | |
|-----------------------|----------|
| ETIM 5.0 | EC001846 |
| ETIM 6.0 | EC001846 |
| ETIM 7.0 | EC001846 |
| ETIM 8.0 | EC001846 |
| UNSPSC 16.0901 | 41111960 |

Dimensional drawing (Dimensions in mm (inch))

UM18-2xxxxxx2

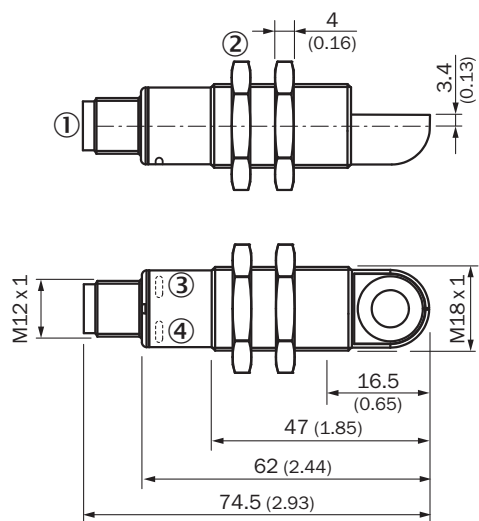

- ① Connection
- ② Fixing nuts, width 24 mm
- ③ Status display for supply voltage active (green)
- ④ Status indicator switching/analog output (orange)

Connection type

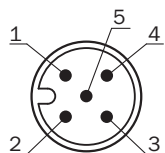

Connection diagram

UM18-21xxxExxx, male connector M12, 5-pin

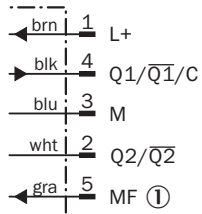

① Multifunctional input/synchronization and multiplex operation/communication Connect+

Detection area

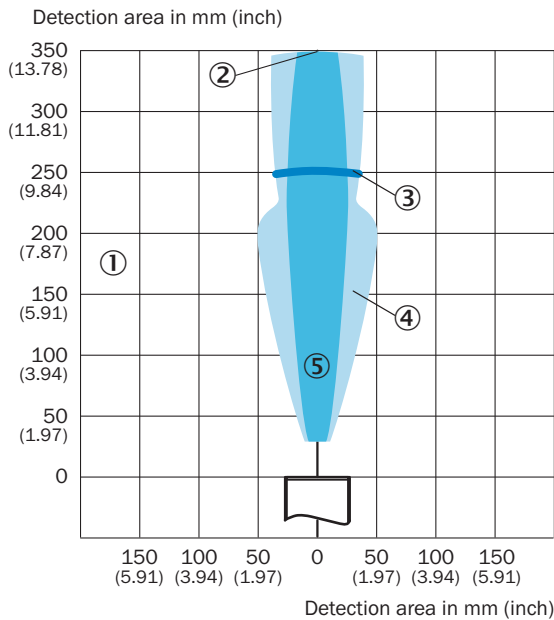

UM18-211



Recommended accessories

Other models and accessories → www.sick.com/UM18

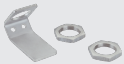
| | Brief description | Type | Part no. |
|---|---|-----------------------------------|----------|
| Connection modules | | | |
|  | IO-Link V1.1 Class A port, USB2.0 port, optional external power supply 24V / 1A | IOLA2US-01101 (SiLink2 Master) | 1061790 |

| | Brief description | Type | Part no. |
|---|---|--------------------|----------|
| Deflector mirrors | | | |
|  | 90° sound deflection plate for UM18-1xxx and UM18-2xxx, stainless steel, for straight versions | USP-UM18 | 5323658 |
| Mounting brackets and plates | | | |
|  | Mounting plate for M18 sensors, steel, zinc coated, without mounting hardware | BEF-WG-M18 | 5321870 |
|  | <ul style="list-style-type: none"> • Connection type head A: Female connector, M12, 5-pin, straight, A-coded • Connection type head B: Flying leads • Signal type: Sensor/actuator cable • Cable: 2 m, 5-wire, PVC • Description: Sensor/actuator cable, unshielded • Application: Zones with chemicals | YF2A15-020VB5XLEAX | 2096239 |

SICK AT A GLANCE

SICK is one of the leading manufacturers of intelligent sensors and sensor solutions for industrial applications. A unique range of products and services creates the perfect basis for controlling processes securely and efficiently, protecting individuals from accidents and preventing damage to the environment.

We have extensive experience in a wide range of industries and understand their processes and requirements. With intelligent sensors, we can deliver exactly what our customers need. In application centers in Europe, Asia and North America, system solutions are tested and optimized in accordance with customer specifications. All this makes us a reliable supplier and development partner.

Comprehensive services complete our offering: SICK LifeTime Services provide support throughout the machine life cycle and ensure safety and productivity.

For us, that is “Sensor Intelligence.”

WORLDWIDE PRESENCE:

Contacts and other locations –www.sick.com